

TH 57114 Μήκος - Length 6.0 m Θεωρ. Βάρος - Theor.Weight 731 gr/m

Τακάκι Σταθερού Τζαμιού Κρυφού Φύλλου
Glass Support for fix Hidden Sash

$I_x=0.99 \text{ cm}^4$ $I_{y(s)}=1.90 \text{ cm}^4$

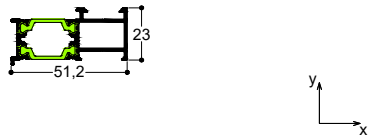

TH 57115 Μήκος - Length 6.0 m Θεωρ. Βάρος - Theor.Weight 976 gr/m

Προέκταση Κάσας 60mm
Frame Extension 60mm

$I_x=2.25 \text{ cm}^4$ $I_{y(s)}=7.85 \text{ cm}^4$

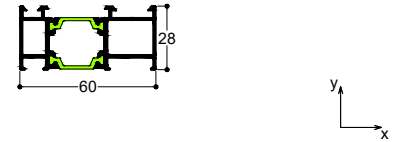

TH 57116 Μήκος - Length 6.0 m Θεωρ. Βάρος - Theor.Weight 1.054 gr/m

Προέκταση Κάσας για TH 57103
Frame Extension for TH 57103

$I_x=2.47 \text{ cm}^4$ $I_{y(s)}=3.05 \text{ cm}^4$

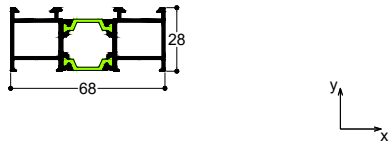

TH 57117 Μήκος - Length 6.0 m Θεωρ. Βάρος - Theor.Weight 1.052 gr/m

Προέκταση Κάσας για TH 57106
Frame Extension for TH 57106

$I_x=2.47 \text{ cm}^4$ $I_{y(s)}=8.82 \text{ cm}^4$

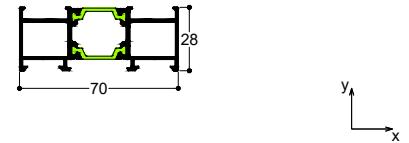

TH 57118 Μήκος - Length 6.0 m Θεωρ. Βάρος - Theor.Weight 1.649 gr/m

Κάσα Αντικαταστάσεων
Replacement Frame

$I_x=7.73 \text{ cm}^4$ $I_{y(s)}=88.08 \text{ cm}^4$

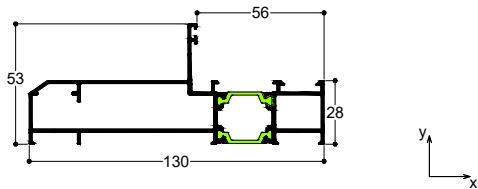

TH 57119 Μήκος - Length 6.0 m Θεωρ. Βάρος - Theor.Weight 1.625 gr/m

Κάσα Συνεπίπεδης Πόρτας
Frame for Level Doors

$I_x=23.53 \text{ cm}^4$ $I_{y(s)}=31.07 \text{ cm}^4$

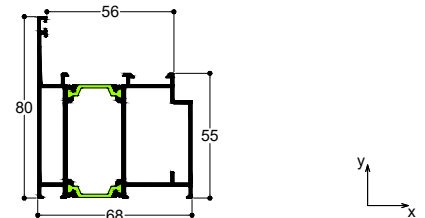

TH 57410 Μήκος - Length 6.0 m Θεωρ. Βάρος - Theor.Weight 1.357 gr/m

Χώρισμα κάσας
Transom for frame

$I_x=9.61 \text{ cm}^4$ $I_{y(s)}=21.06 \text{ cm}^4$

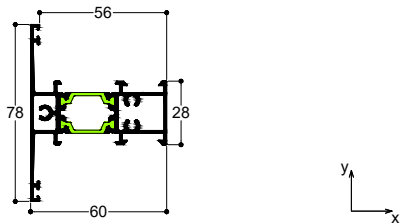

TH 57411 Μήκος - Length 6.0 m Θεωρ. Βάρος - Theor.Weight 1.811 gr/m

Μεγάλο Χώρισμα Κάσας
Transom for frame

$I_x=34.21 \text{ cm}^4$ $I_{y(s)}=29.21 \text{ cm}^4$

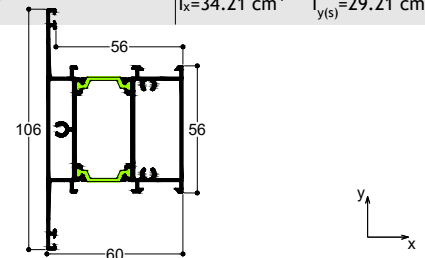

TH 57412 Μήκος - Length 6.0 m Θεωρ. Βάρος - Theor.Weight 1.330 gr/m

Χώρισμα φύλλου
Transom for Window Sash

$I_x=8.1 \text{ cm}^4$ $I_{y(s)}=25.83 \text{ cm}^4$

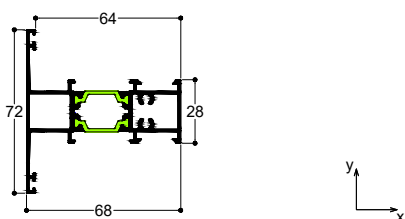

TH 57413 Μήκος - Length 6.0 m Θεωρ. Βάρος - Theor.Weight 1.300 gr/m

Χώρισμα Σπαστού φύλλου
Transom for Chamfered Sash

$I_x=9.48 \text{ cm}^4$ $I_{y(s)}=19.94 \text{ cm}^4$

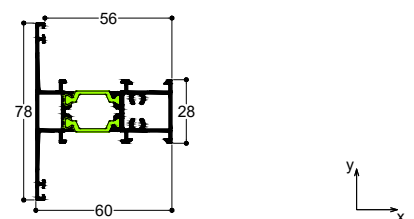

TH 57610	Μήκος - Length 6.0 m	Θεωρ. Βάρος - Theor. Weight 840 gr/m
Μετατροπέας Φύλλου σε Κάσα Sash to Frame Converter	$I_x=3.54 \text{ cm}^4$	$I_{y(s)}=15.07 \text{ cm}^4$

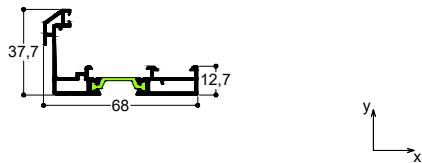

TV 57504	Μήκος - Length 6.0 m	Θεωρ. Βάρος - Theor. Weight 384 gr/m
Πηχάκι Τζαμιού Glazing Bead	$I_x=1.05 \text{ cm}^4$	$I_{y(s)}=1.92 \text{ cm}^4$

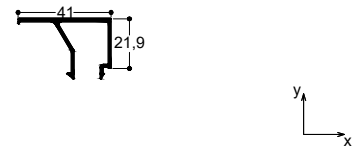

TV 57607	Μήκος - Length 6.0 m	Θεωρ. Βάρος - Theor. Weight 189 gr/m
Πρόσθετο Προφίλ Κυκλικής Κολώνας Additional Profile for Round Mullion	$I_x=0.40 \text{ cm}^4$	$I_{y(s)}=0.29 \text{ cm}^4$



TV 57608	Μήκος - Length 6.0 m	Θεωρ. Βάρος - Theor. Weight 159 gr/m
Πρόσθετο Προφίλ Κυκλικής Κολώνας Additional Profile for Round Mullion	$I_x=0.37 \text{ cm}^4$	$I_{y(s)}=0.07 \text{ cm}^4$



TV 57609	Μήκος - Length 6.0 m	Θεωρ. Βάρος - Theor. Weight 155 gr/m
Πρόσθετο Προφίλ Κυκλικής Κολώνας Additional Profile for Round Mullion	$I_x=0.08 \text{ cm}^4$	$I_{y(s)}=0.31 \text{ cm}^4$



TV 57628	Μήκος - Length 6.0 m	Θεωρ. Βάρος - Theor. Weight 193 gr/m
Συνδεδετικό TH 57114 Connector for TH 57114		-



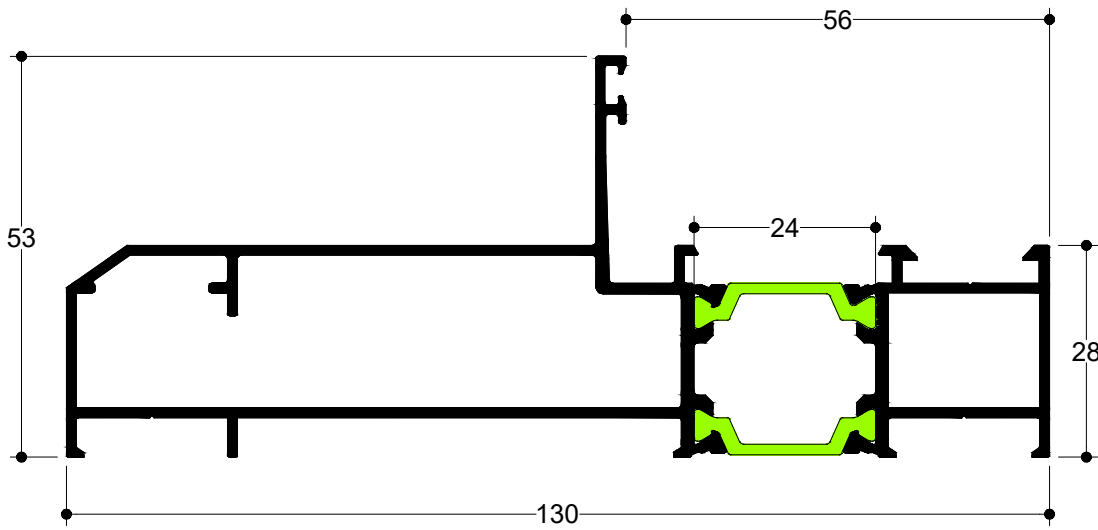

TH 57118

6.0 m 1.649 gr/m
Κάσα Αντικαταστάσεων
Replacement Frame

TH 57119

6.0 m 1.625 gr/m
Κάσα Συνεπίπεδης Πόρτας
Frame for Level Doors

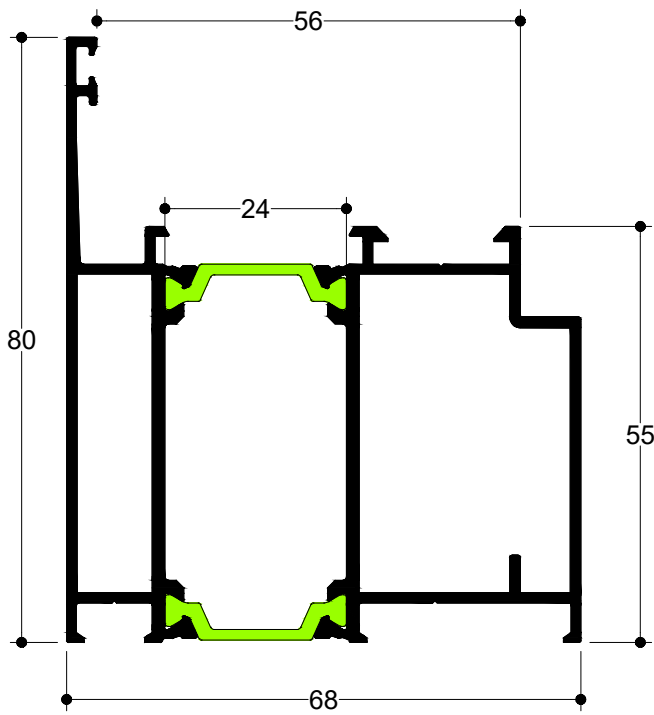

TV 57504

6.0 m 384 gr/m
Πηχάκι Τζαμιού Ίσιο
Straight Glass Clip

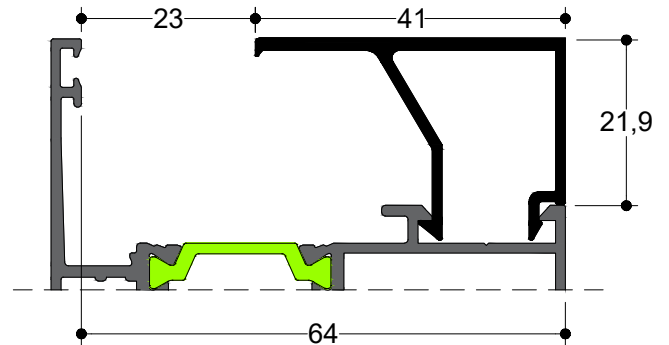

TH 57201

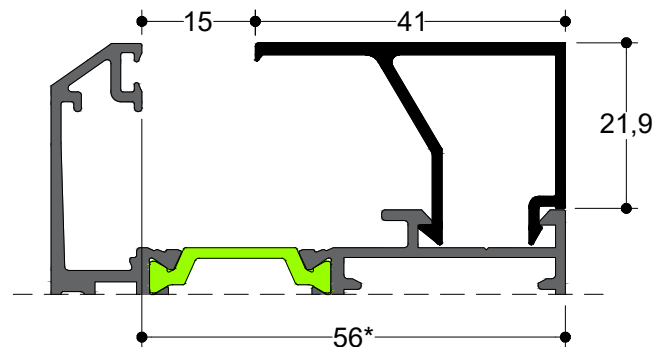

TH 57205

TH 57610

6.0 m 840 gr/m
Μετατροπέας Φύλλου σε Κάσα
Sash to Frame Converter

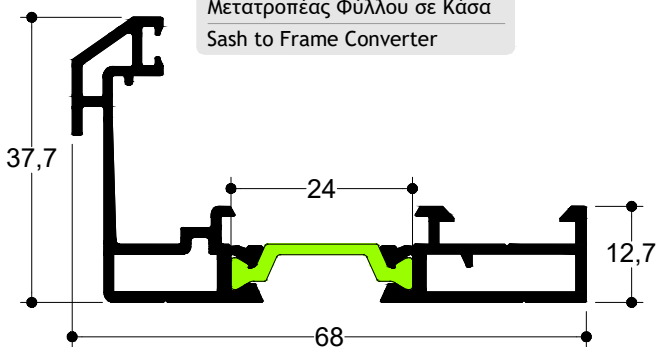

* Ίδιο διάκενο με τα προφίλ κασών
* Same gap with frame profiles

TH 57410

6.0 m 1.357 gr/m

Χώρισμα κάσας

Transom for frame

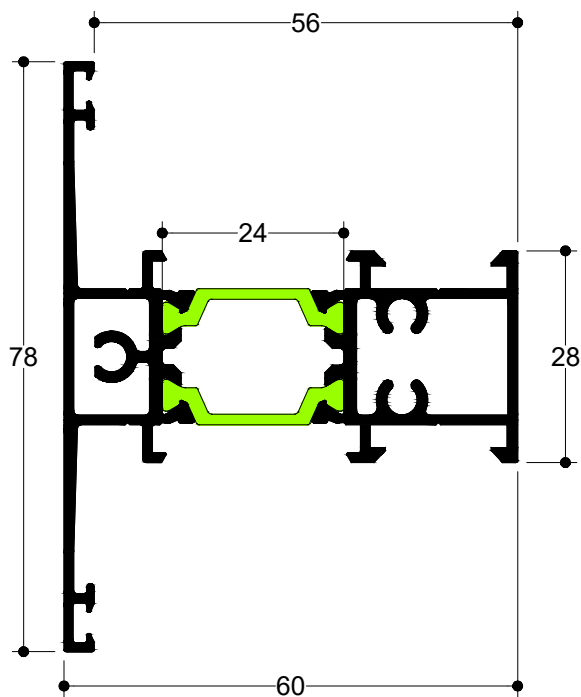

TH 57411

6.0 m 1.811 gr/m

Μεγάλο Χώρισμα Κάσας

Transom for frame

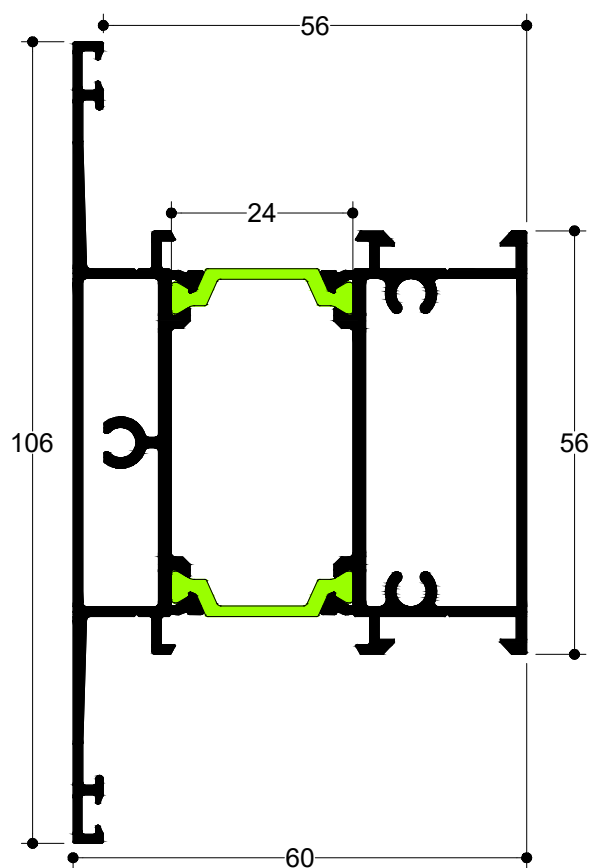

TH 57412

6.0 m 1.330 gr/m

Χώρισμα φύλλου

Transom for Window Sash

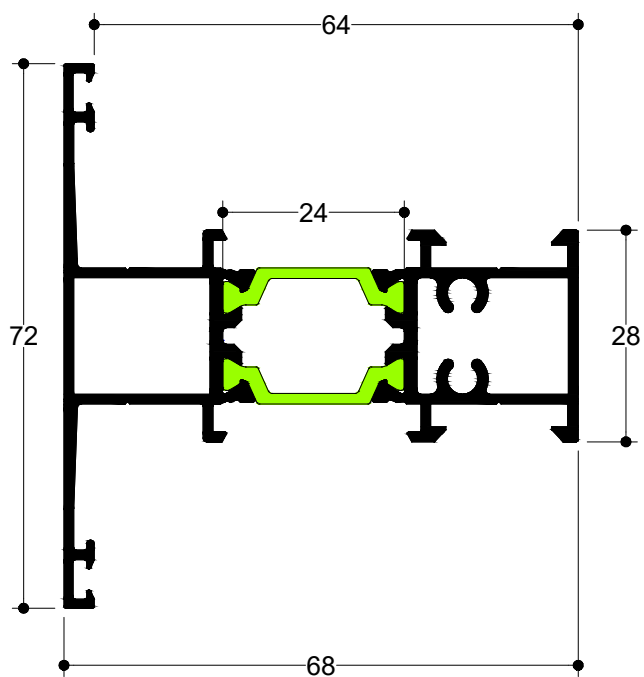

TH 57413

6.0 m 1.300 gr/m

Χώρισμα Σπαστού φύλλου

Transom for Chamfered Sash

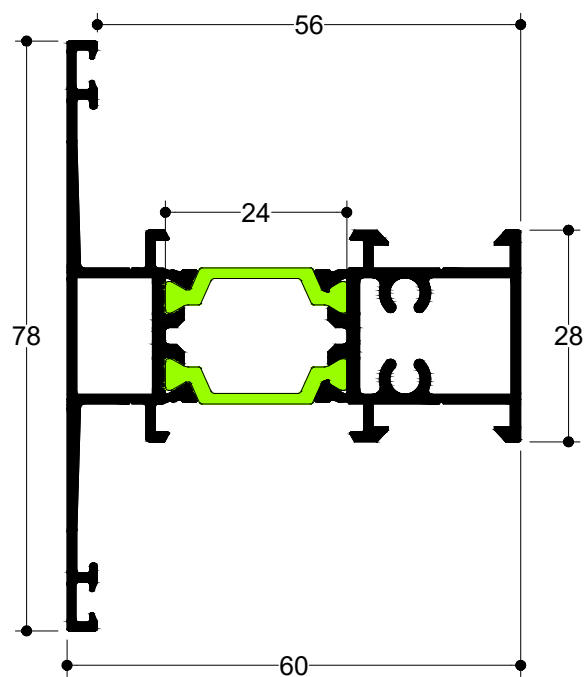

TH 57114

6.0 m 731 gr/m

Τακάκι Σταθερού Τζαμιού Κρυφού Φύλλου
Glass Support for fix Hidden Sash

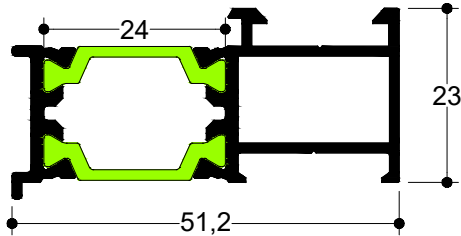

TH 57115

6.0 m 976 gr/m

Προέκταση Κάσας 60 mm
Frame Extension 60 mm

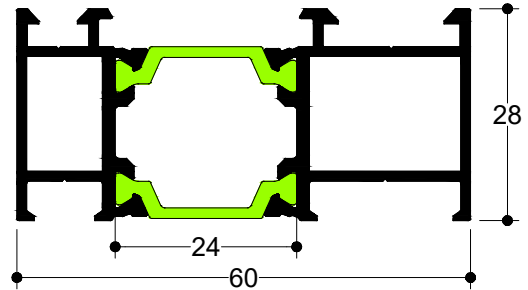

TH 57116

6.0 m 1.054 gr/m

Προέκταση Κάσας για TH 57103
Frame Extension for TH 57103

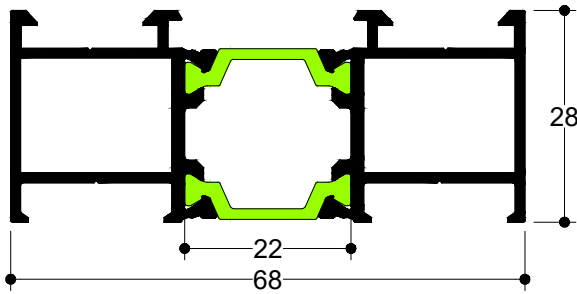

TH 57117

6.0 m 1.052 gr/m

Προέκταση Κάσας για TH 57106
Frame Extension for TH 57106

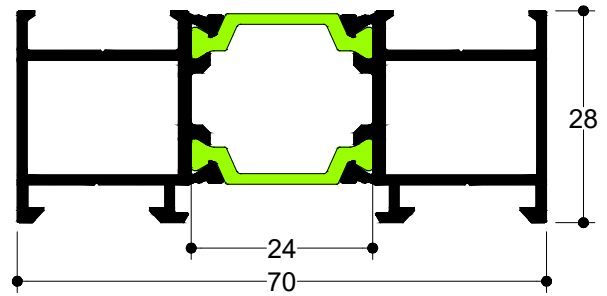

TV 57607

6.0 m 189 gr/m

Πρόσθετο Προφίλ Κυκλικής Κολώνας
Additional Profile for Round Mullion

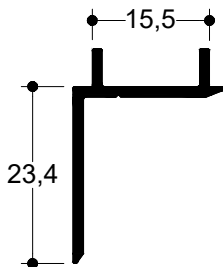

TV 57608

6.0 m 159 gr/m

Πρόσθετο Προφίλ Κυκλικής Κολώνας
Additional Profile for Round Mullion

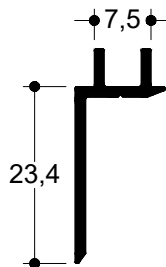

TV 57609

6.0 m 155 gr/m

Πρόσθετο Προφίλ Κυκλικής Κολώνας
Additional Profile for Round Mullion

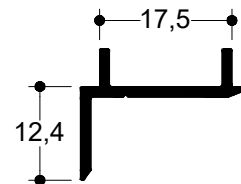

TV 57628

6.0 m 193 gr/m

Συνδετικό TH 57114
Connector for TH 57114

