

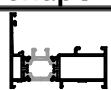

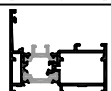

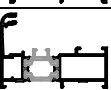

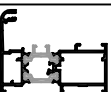

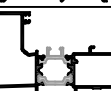
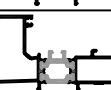
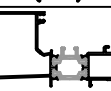

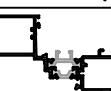
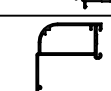
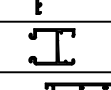
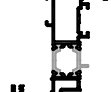
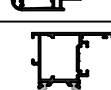
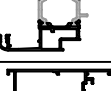
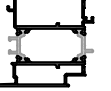
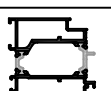
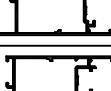
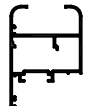
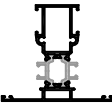
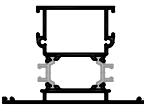
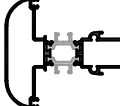
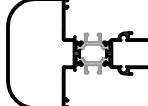
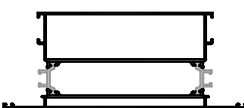
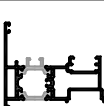
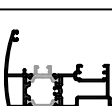
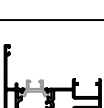
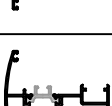
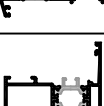
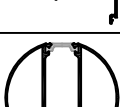



ΚΩΔΙΚΟΣ code	ΣΧΗΜΑ shape	ΒΑΡΟΣ gr/m weight gr/m	ΜΗΚΟΣ length	ΠΕΡΙΓΡΑΦΗ description	ΣΕΛΙΔΑ page
22140		1094	6m	ΚΑΣΑ ΙΣΙΑ ΧΑΜΗΛΗ straight low outer frame	6
22142		1223	6m	ΚΑΣΑ ΙΣΙΑ ΨΗΛΗ straight outer frame	6
22144		1199	6m	ΚΑΣΑ ΠΟΜΠΕ ΜΙΚΡΗ ΧΑΜΗΛΗ curved low outer frame	6
22146		1322	6m	ΚΑΣΑ ΠΟΜΠΕ ΜΙΚΡΗ ΨΗΛΗ curved outer frame	6
22149		1520	6m	ΚΑΣΑ ΠΟΜΠΕ ΜΕΣΑΙΑ ΨΗΛΗ curved outer frame	7
22148		1438	6m	ΚΑΣΑ ΠΟΜΠΕ ΜΕΣΑΙΑ ΧΑΜΗΛΗ curved low outer frame	7
22150		1561	6m	ΚΑΣΑ ΠΟΜΠΕ ΜΕΓΑΛΗ ΧΑΜΗΛΗ curved outer frame	7
22152		2264	6m	ΚΑΣΑ ΕΝΙΑΙΑ ΨΗΛΗ compact outer frame	6
22154		1340	6m	ΚΑΣΑ ΔΙΑΙΡΟΥΜΕΝΗ (ΕΣΩΤΕΡΙΚΟ ΤΜΗΜΑ) adjustable inner frame	8
8120		600	6m	ΚΑΣΑ ΔΙΑΙΡΟΥΜΕΝΗ (ΕΞΩΤΕΡΙΚΟ ΤΜΗΜΑ) adjustable outer frame	8
8122		343	6m	ΠΡΟΣΘΕΤΟ ΔΙΑΙΡΟΥΜΕΝΗΣ ΚΑΣΑΣ variable width adaptor	8
22230		1320	6m	ΦΥΛΛΟ ΠΑΡΑΘΥΡΟΥ window sash	8
22232		1497	6m	ΦΥΛΛΟ ΜΠΑΛΚΟΝΟΠΟΡΤΑΣ large window sash	8
22234		1849	6m	ΦΥΛΛΟ ΠΟΡΤΑΣ door sash	8
22236		1867	6m	ΦΥΛΛΟ ΠΟΡΤΑΣ ΑΝΟΙΓΟΜΕΝΗΣ ΕΞΩ door sash opening out	8
22238		1940	6m	ΦΥΛΛΟ ΠΟΡΤΑΣ ΠΕΡΙΜΕΤΡΙΚΟΥ ΜΗΧΑΝ. multilock door sash	9
22240		1480	6m	ΦΥΛΛΟ ΠΕΡΙΜΕΤΡΙΚΟΥ ΜΗΧΑΝΙΣΜΟΥ multilock window sash	9

ΚΩΔΙΚΟΣ code	ΣΧΗΜΑ shape	ΒΑΡΟΣ gr/m weight gr/m	ΜΗΚΟΣ length	ΠΕΡΙΓΡΑΦΗ description	ΣΕΛΙΔΑ page
8210		903	6m	ΦΥΛΛΟ ΠΑΝΤΖΟΥΡΙΟΥ shutter sash	14
22350		1252	6m	ΤΑΦ ΜΙΚΡΟ small mullion	10
22352		1641	6m	ΤΑΦ ΜΕΣΑΙΟ large mullion	11
22354		1542	6m	ΤΑΦ ΠΟΜΠΕ ΜΕΣΑΙΟ small curved mullion	11
22356		1649	6m	ΤΑΦ ΠΟΜΠΕ ΜΕΓΑΛΟ large curved mullion	11
22370		2692	6m	ΤΑΦ ή ΤΑΜΠΛΑΣ ΠΟΡΤΑΣ bottom rail	10
22620		1266	6m	ΜΠΙΝΙ ΙΣΙΟ straight central adaptor	10
22622		1314	6m	ΜΠΙΝΙ ΠΟΜΠΕ curved central adaptor	10
22624		1267	6m	ΜΠΙΝΙ ΙΣΙΟ ΠΕΡΙΜΕΤΡΙΚΟΥ ΜΗΧΑΝΙΣΜΟΥ multilock straight central adaptor	9
22626		1314	6m	ΜΠΙΝΙ ΠΟΜΠΕ ΠΕΡΙΜΕΤΡΙΚΟΥ ΜΗΧΑΝΙΣΜ. multilock curved central adaptor	9
22628		1216	6m	ΠΡΟΣΘΗΚΗ ΕΞΩΤΕΡΚΟΥ ΑΝΟΙΓΜΑΤΟΣ reverse action adaptor for doors & vents	10
22740		1617	6m	ΚΟΛΩΝΑ ΓΙΑ ΜΕΤΑΒΛΗΤΕΣ ΓΩΝΙΕΣ cylindrical column for variable angles	13
22742		195	6m	ΠΡΟΣΘΗΚΗ ΓΙΑ ΜΕΤΑΒΛΗΤΕΣ ΓΩΝΙΕΣ adaptor for variable angles	13
22744		164	6m	ΠΡΟΣΘΗΚΗ ΓΙΑ ΜΕΤΑΒΛΗΤΕΣ ΓΩΝΙΕΣ adaptor for variable angles	13

ΣΥΝΟΠΤΙΚΟ summary

ΚΩΔΙΚΟΣ code	ΣΧΗΜΑ shape	ΒΑΡΟΣ gr/m weight gr/m	ΜΗΚΟΣ length	ΠΕΡΙΓΡΑΦΗ description	ΣΕΛΙΔΑ page
22520		404	6m	ΑΡΜΟΚΑΛΥΠΤΡΟ ΚΟΥΜΠΩΤΟ wall cover	13
8504		412	6m	ΑΡΜΟΚΑΛΥΠΤΡΟ wall cover	13
8506		285	6m	ΑΡΜΟΚΑΛΥΠΤΡΟ ΚΟΥΜΠΩΤΟ ΜΙΚΡΟ wall cover	13
22438		343	6m	ΠΡΟΣΘΕΤΟ ΤΑΜΠΛΑ-ΑΕΡΟΣΤΕΓΑΝΩΣΗ adaptong for bottom rail's air-tightnes	14
5013		333	6m	ΠΗΧΑΚΙ ΙΣΙΟ ΔΙΠΛΟΥ ΥΑΛΟΠΙΝΑΚΑ glazing bead	12
5013A		317	6m	ΠΗΧΑΚΙ ΠΟΜΠΕ ΔΙΠΛΟΥ ΥΑΛΟΠΙΝΑΚΑ glazing bead	12
22444		302	6m	ΠΗΧΑΚΙ ΙΣΙΟ glazing bead	12
8402		317	6m	ΠΗΧΑΚΙ ΙΣΙΟ ΔΙΠΛΟΥ ΥΑΛΟΠΙΝΑΚΑ glazing bead	12
8404		255	6m	ΠΗΧΑΚΙ ΙΣΙΟ glazing bead	13
8406		255	6m	ΠΗΧΑΚΙ ΠΟΜΠΕ glazing bead	12
8408		271	6m	ΠΗΧΑΚΙ ΙΣΙΟ glazing bead	12
8410		232	6m	ΠΗΧΑΚΙ ΠΟΜΠΕ ΜΕ ΚΛΙΠ glazing bead	12
8412		284	6m	ΠΗΧΑΚΙ ΜΕ ΚΛΙΠ ΔΙΠΛΟΥ ΥΑΛΟΠΙΝΑΚΑ glazing bead	12
8414		151	6m	ΠΗΧΑΚΙ ΕΙΔΙΚΩΝ ΧΡΗΣΕΩΝ glazing bead	13
8112		261	6m	ΠΡΟΣΘΗΚΗ ΥΨΟΥΣ ΚΑΣΑΣ (23mm) adjustable height profile	14
8113		205	6m	ΠΡΟΣΘΗΚΗ ΥΨΟΥΣ ΚΑΣΑΣ (15mm) adjustable height profile	14
8704		305	6m	ΠΡΟΣΘΗΚΗ ΣΤΕΓΑΝΩΣΗΣ ΠΟΡΤΑΣ water sealing profile for doo sashes	14
8706		338	6m	ΚΑΤΩΦΛΙ threshold	14
8714		208	6m	ΠΡΟΣΘΗΚΗ ΑΕΡΟΣΤΕΓΑΝΩΣΗΣ ΠΟΡΤΑΣ air tightness profile for door sashes	14
8716		292	6m	ΚΑΤΩΦΛΙ threshold	14
8730		251	6m	ΠΡΟΣΘΗΚΗ ΑΕΡΟΣΤΕΓΑΝΩΣΗΣ ΠΟΡΤΑΣ air tightness profile for door sashes	14
204		127	6m	ΝΤΙΖΑ connecting rod	14
207		198	6m	ΝΕΡΟΧΥΤΗΣ ΦΥΛΛΟΥ water deflector	14

ΠΡΟΦΙΛ 1:1
profiles 1:1

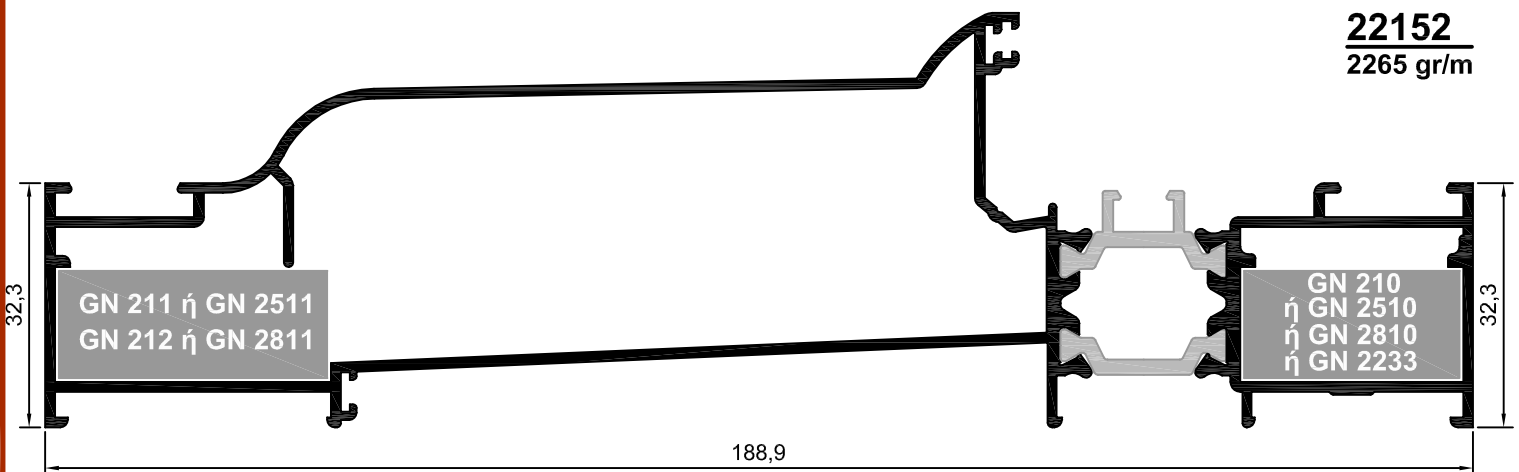
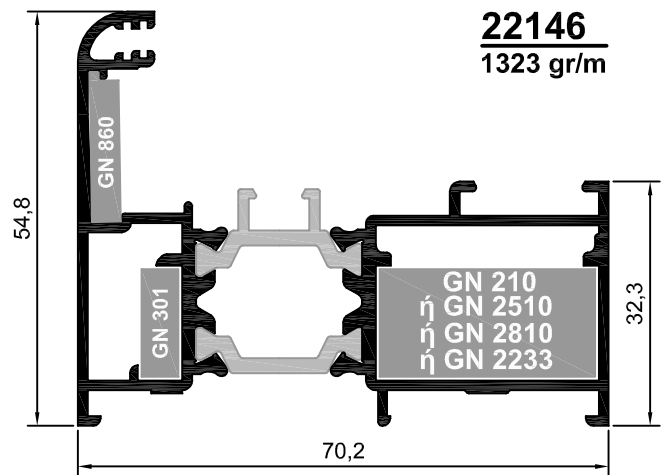
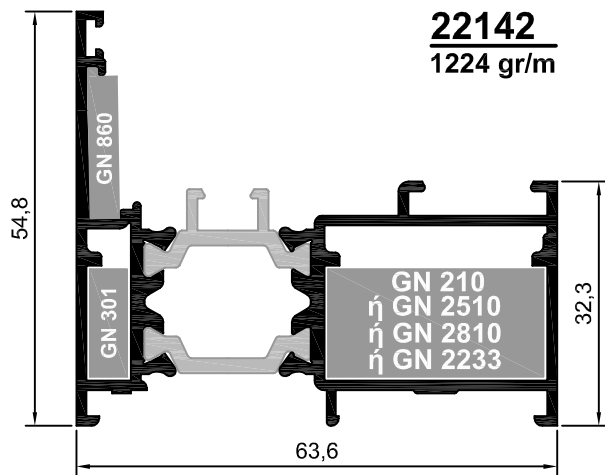
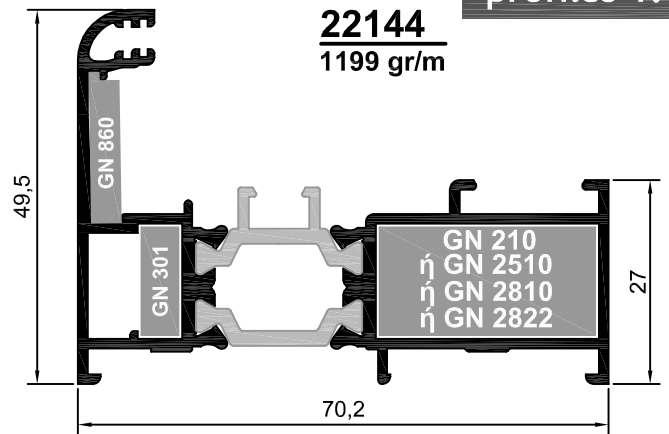
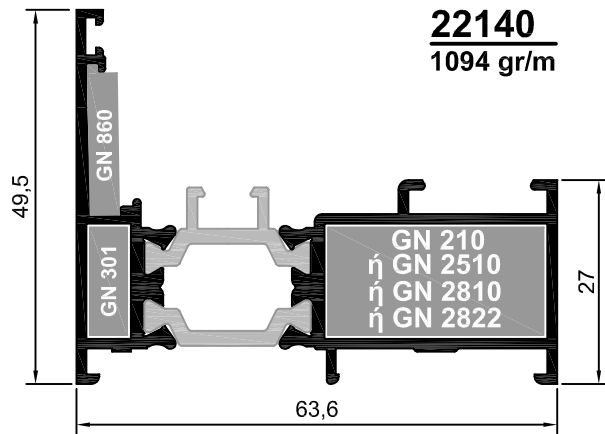

ΠΡΟΦΙΛ 1:1
profiles 1:1

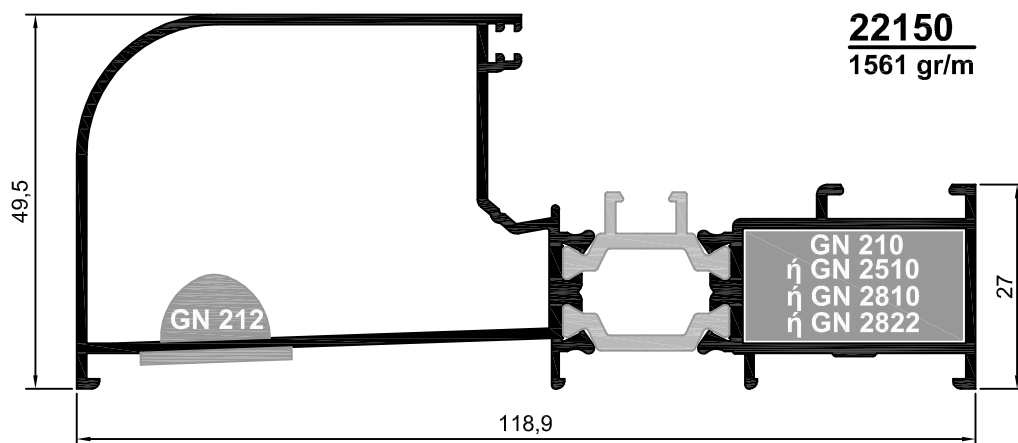
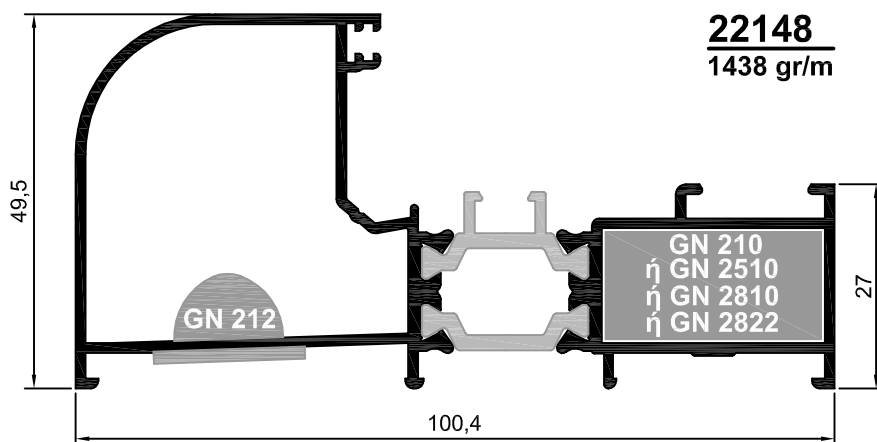
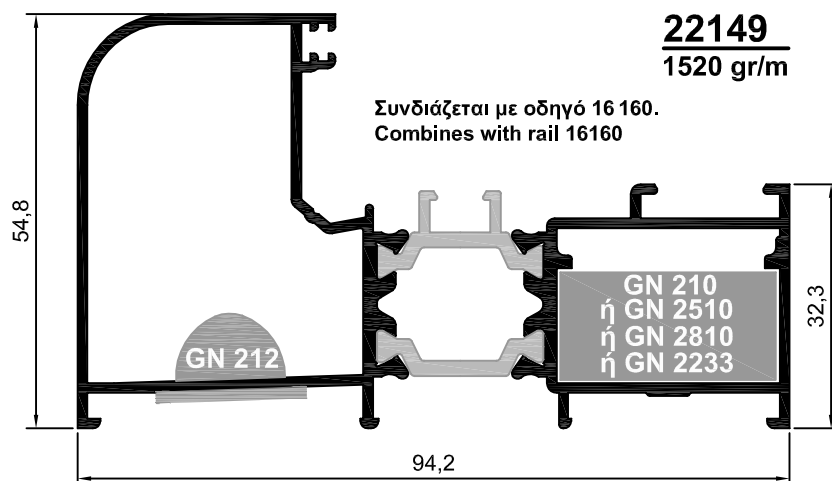

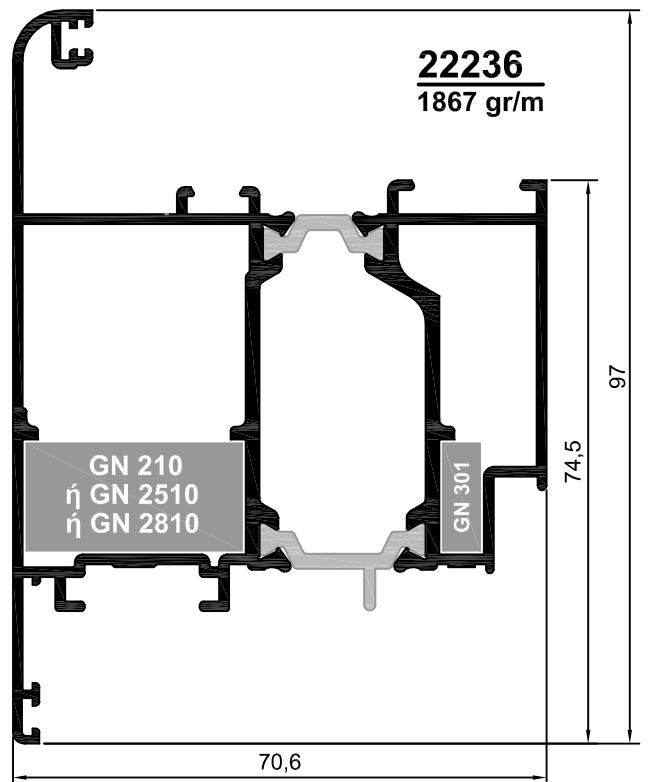
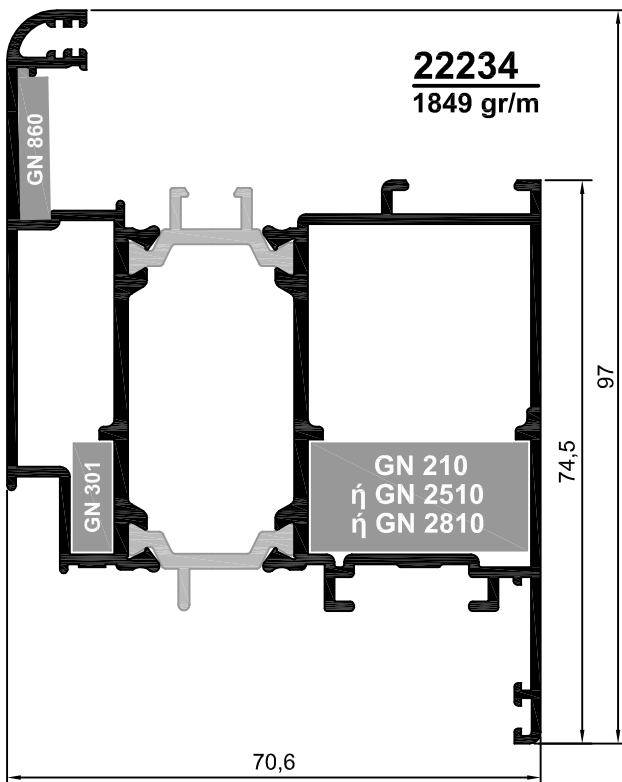
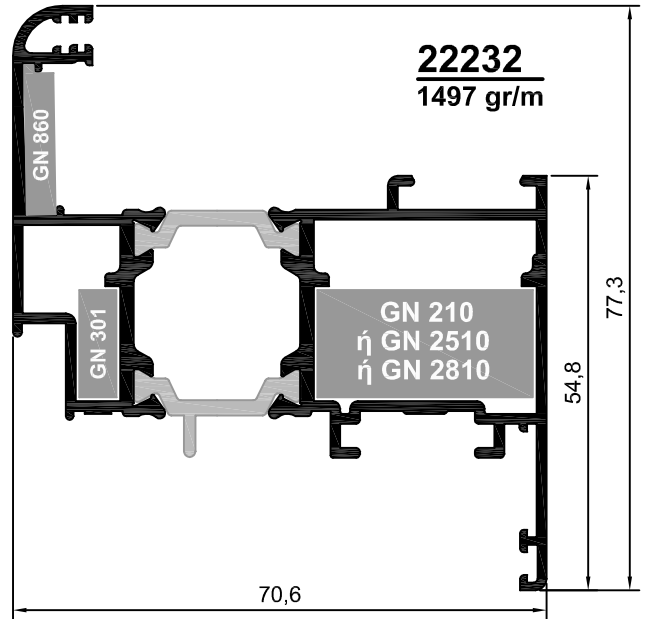
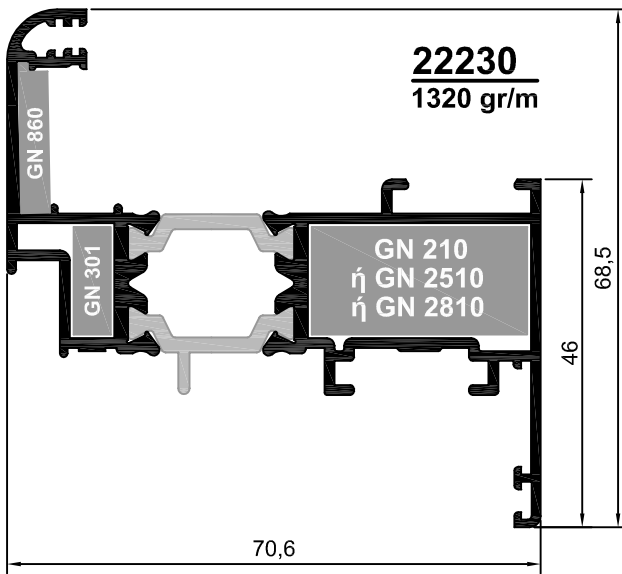
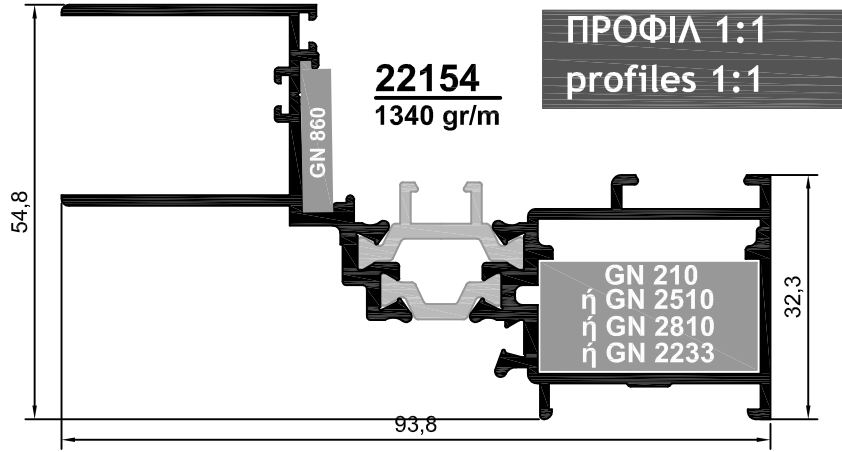
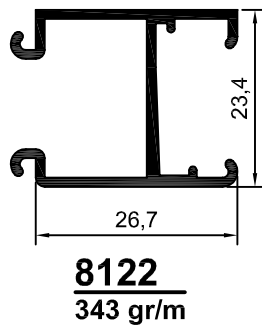
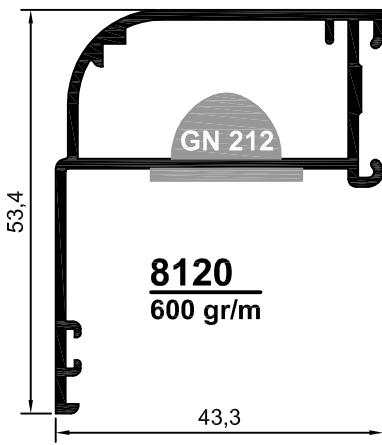

Προφίλ Περιμετρικού Μηχανισμού

profiles for multi lock system

ΠΡΟΦΙΛ 1:1
profiles 1:1

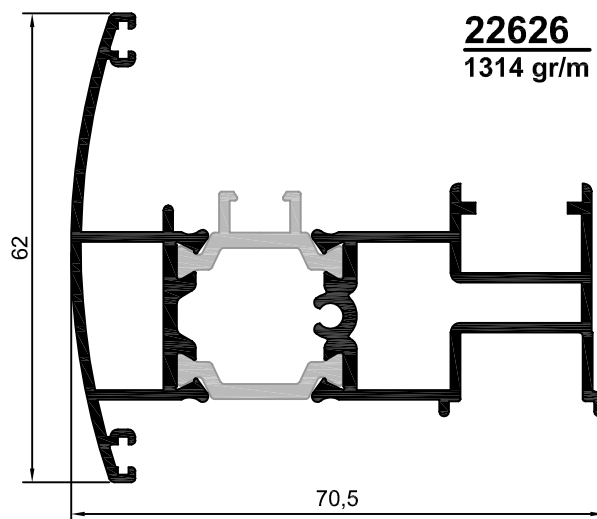
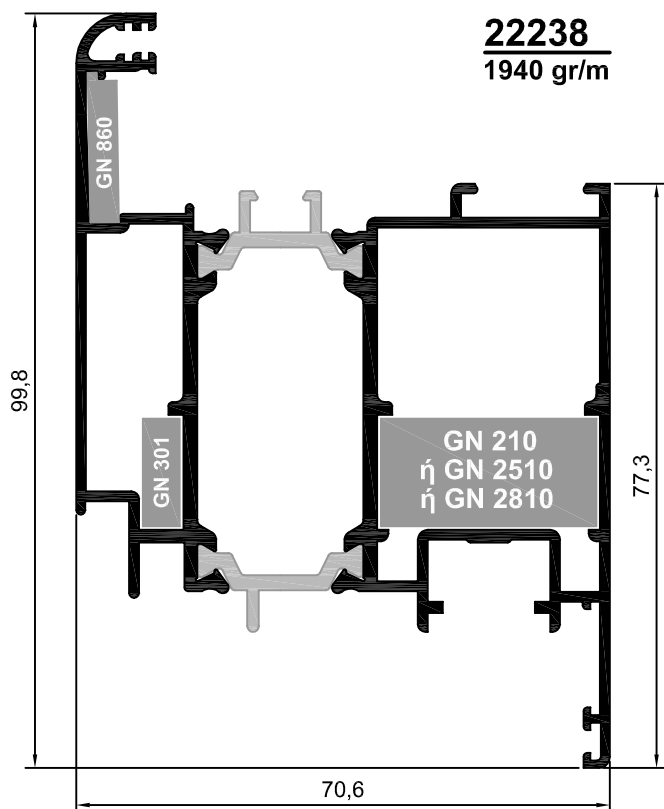
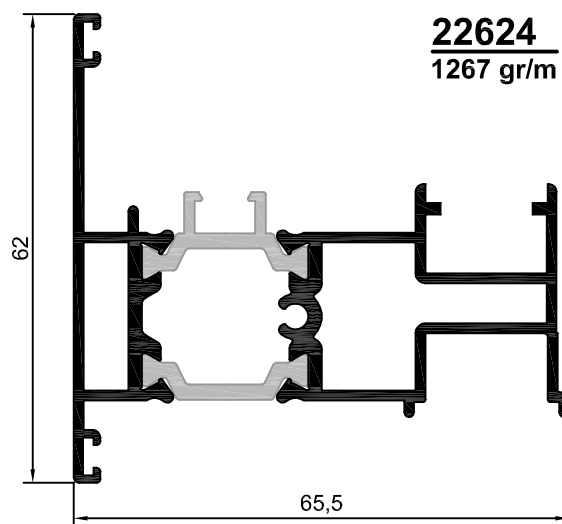
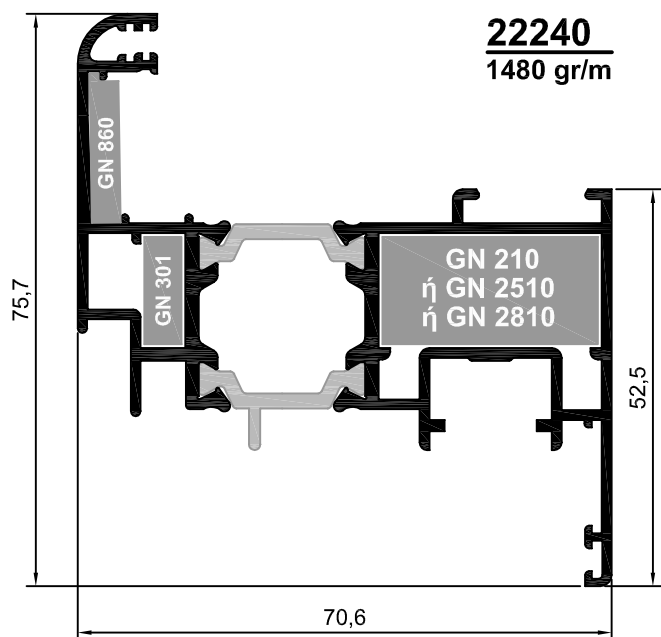

ΠΡΟΦΙΛ 1:1
profiles 1:1

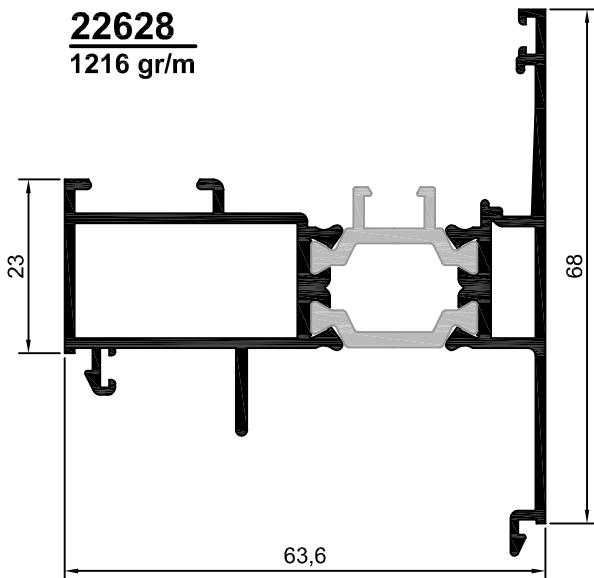
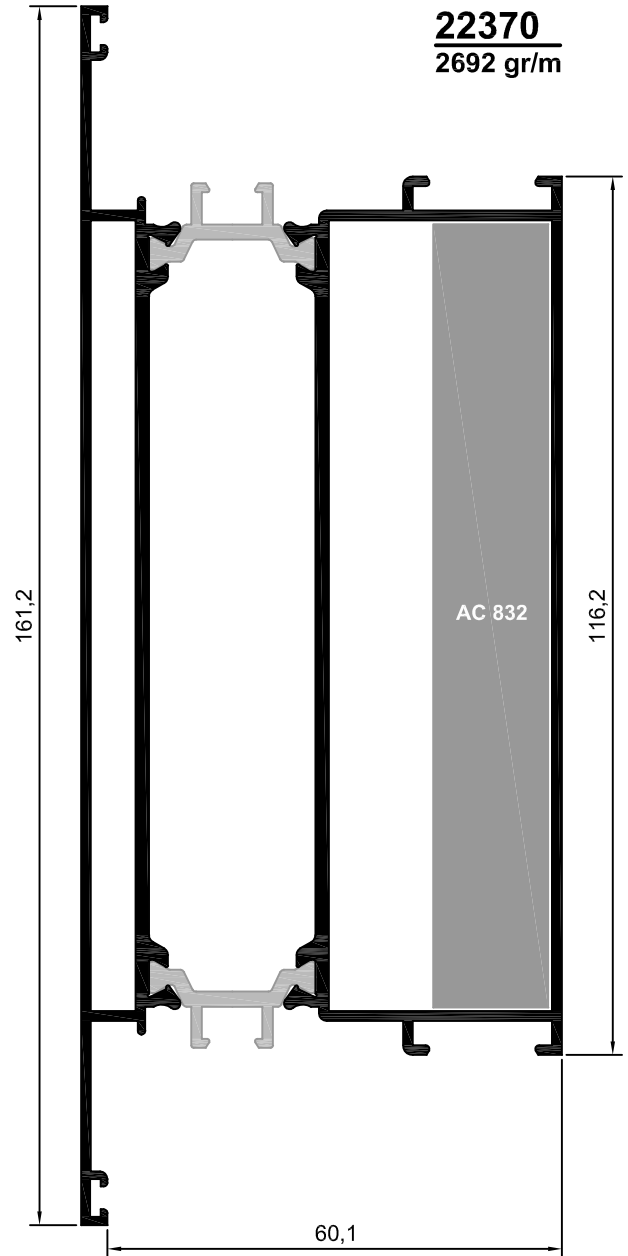
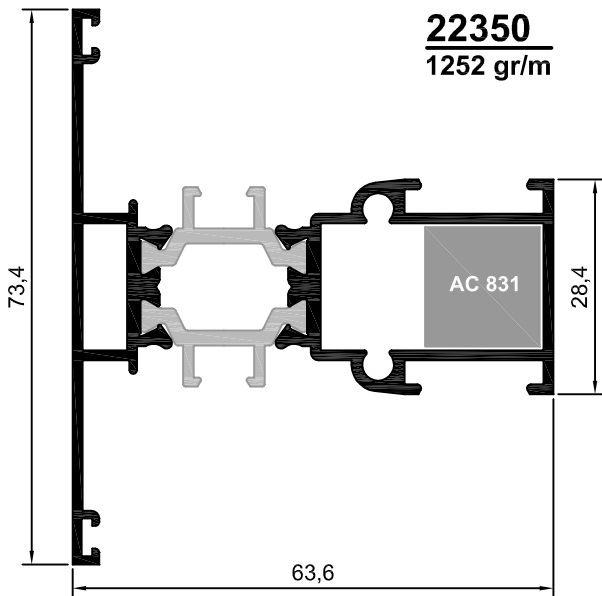
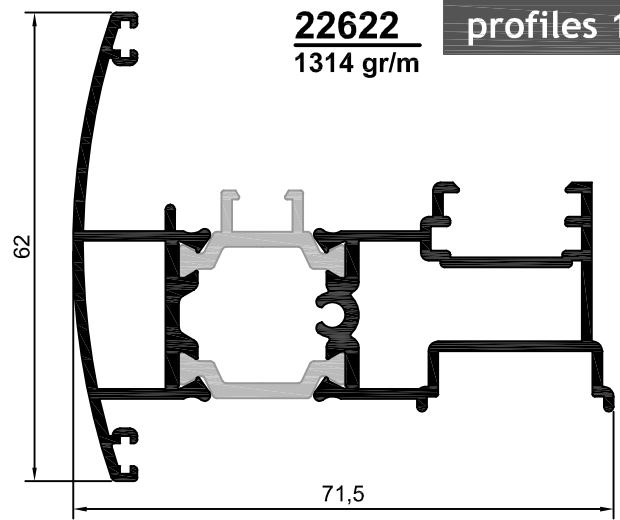
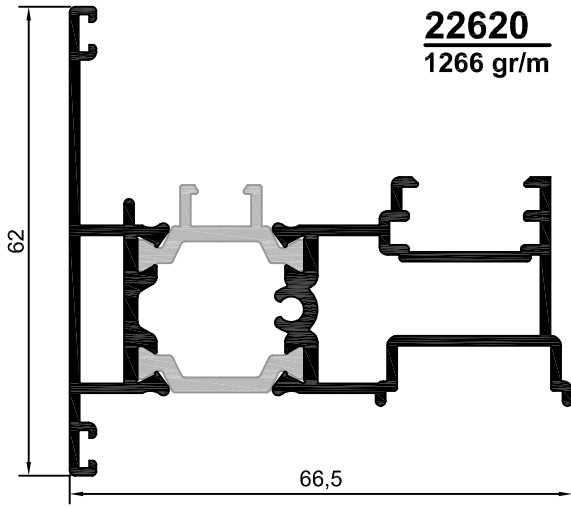

ΠΡΟΦΙΛ 1:1
profiles 1:1

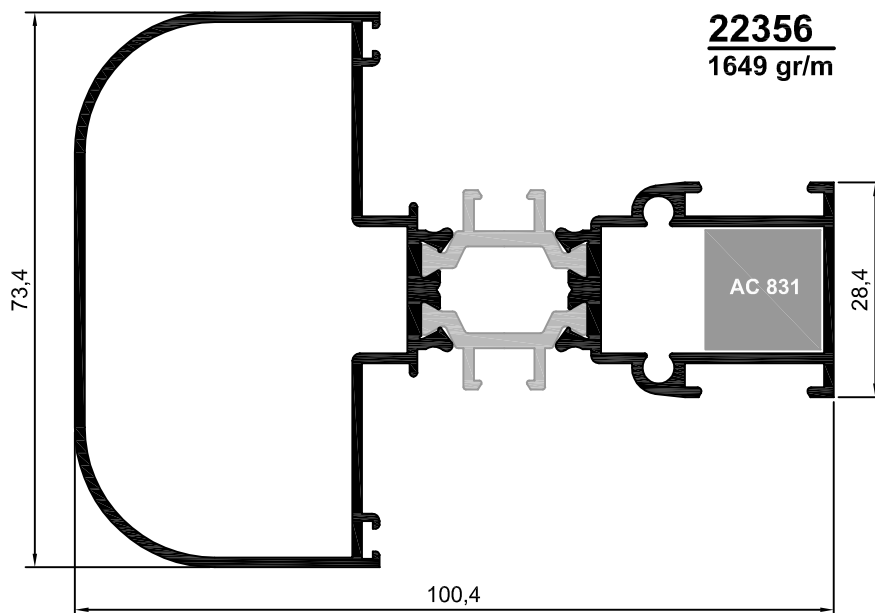
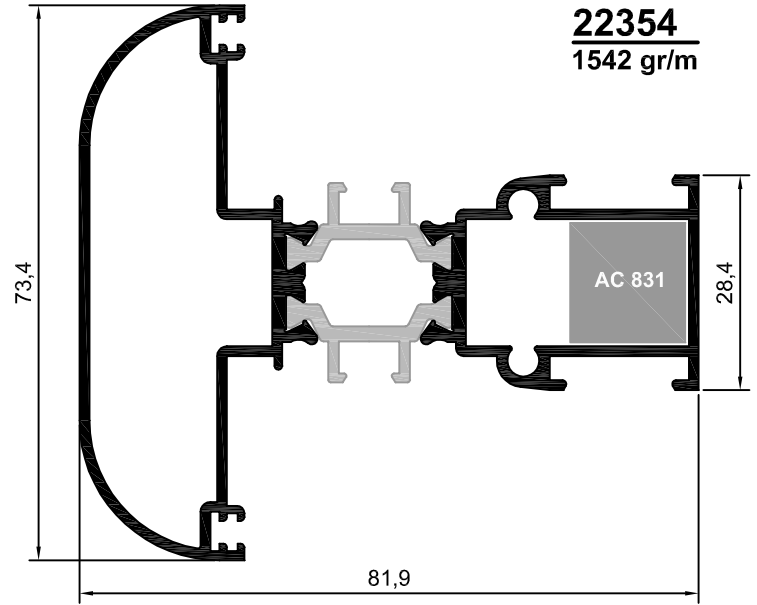
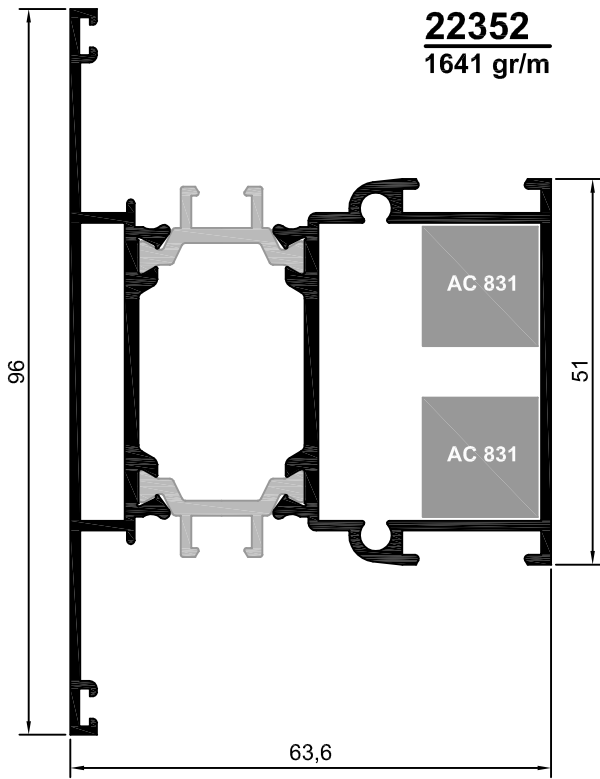

ΠΡΟΦΙΛ 1:1
profiles 1:1

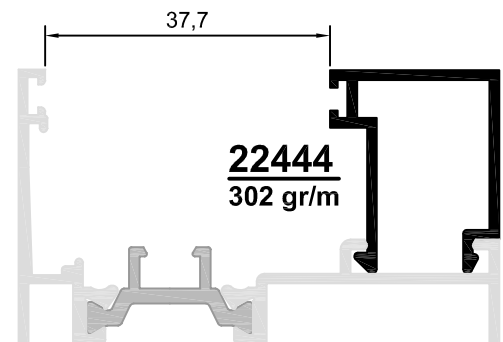
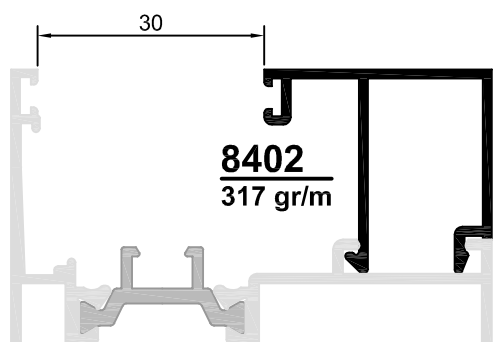
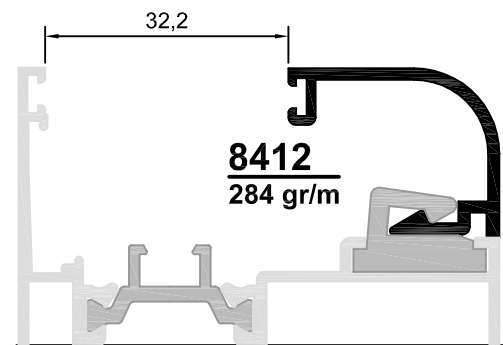
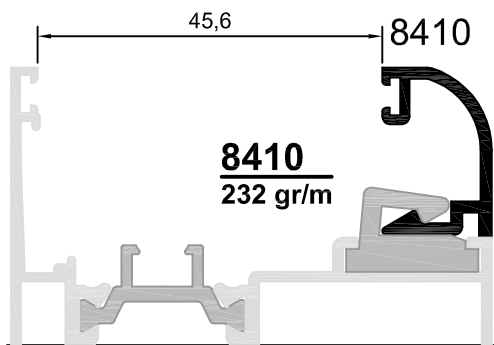
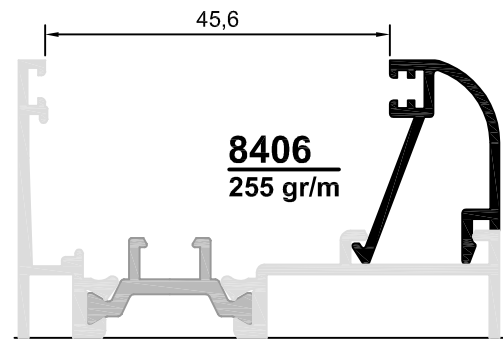
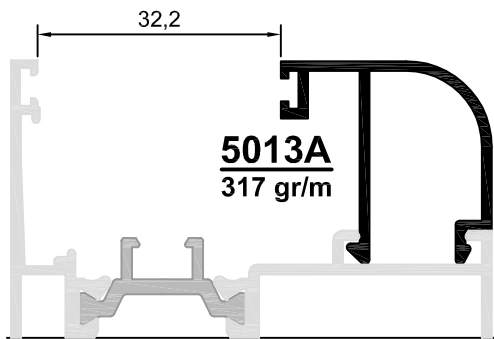
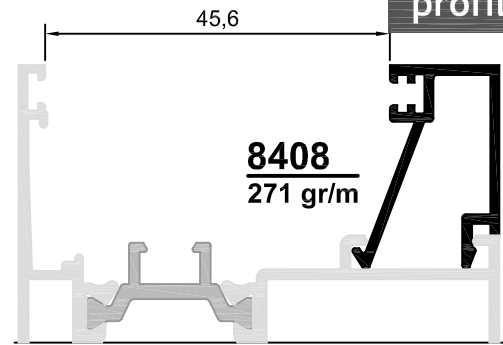
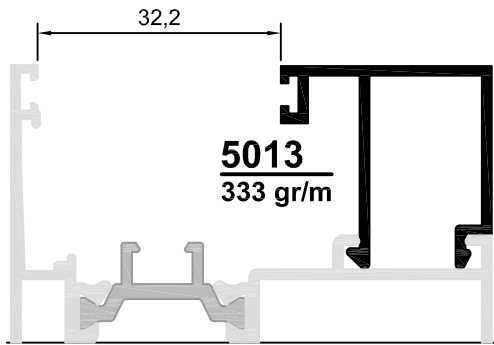

ΠΡΟΦΙΛ 1:1
profiles 1:1

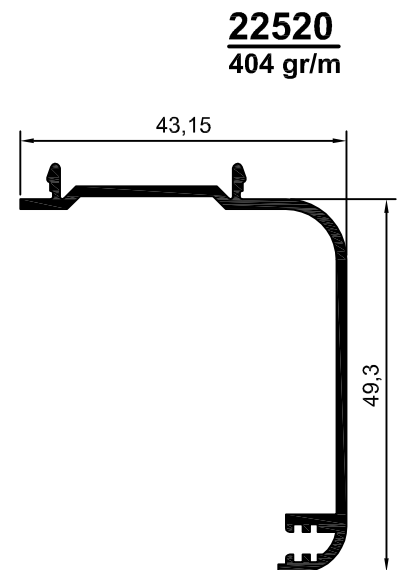
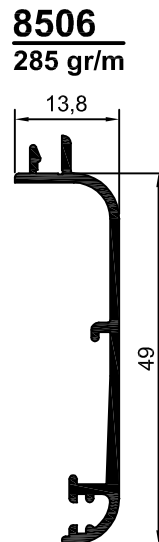
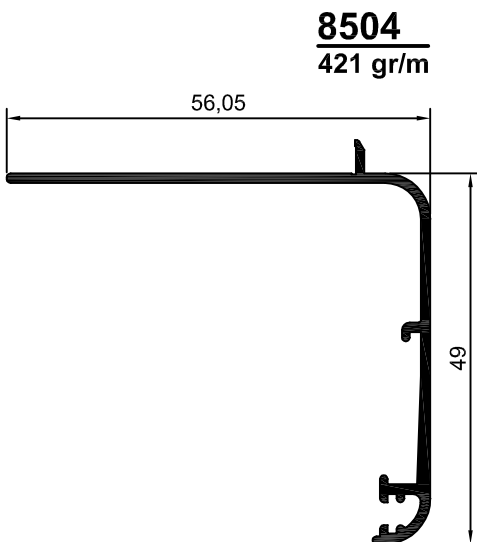
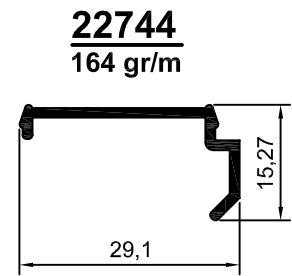
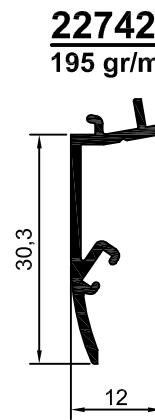
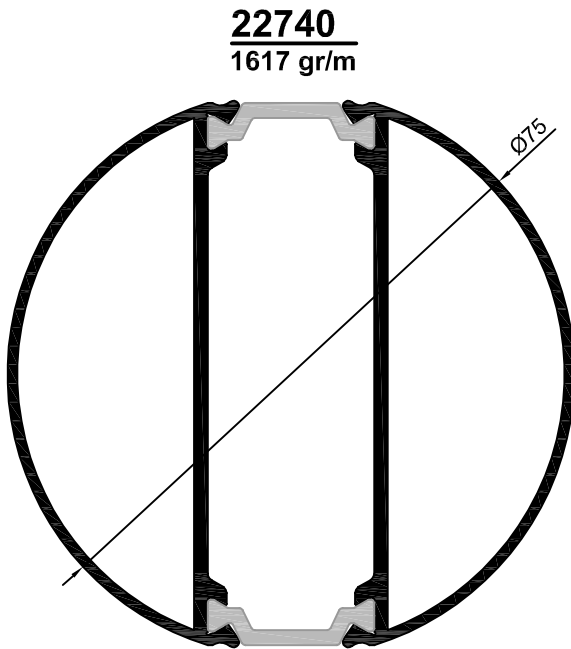
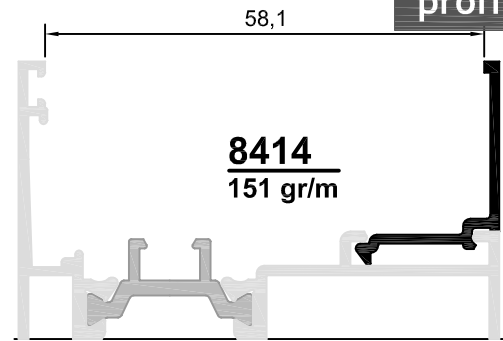
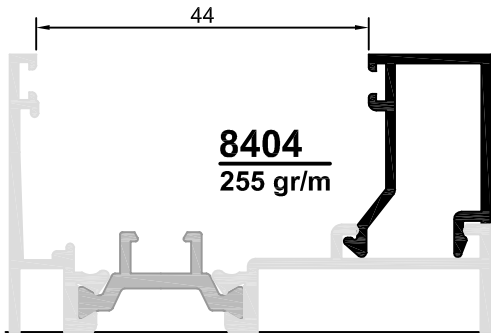

ΠΡΟΦΙΛ 1:1
profiles 1:1

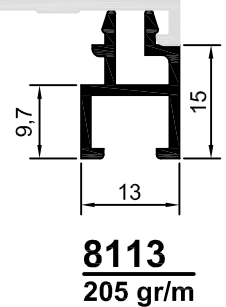
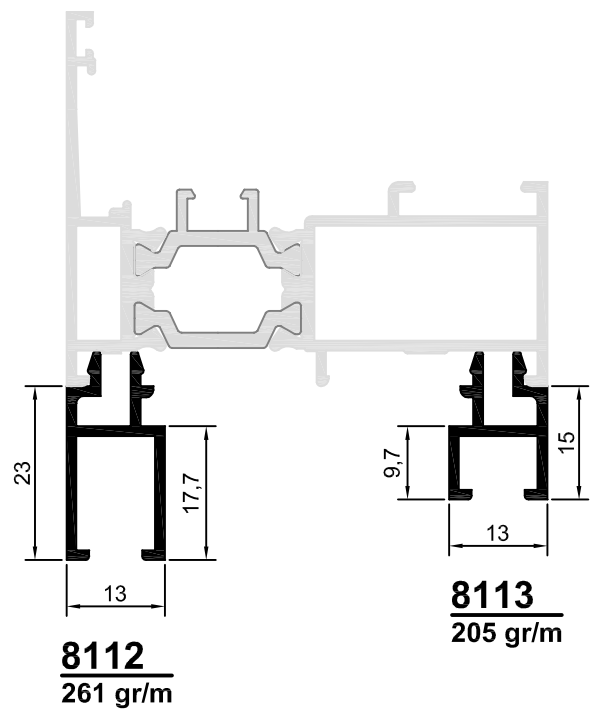
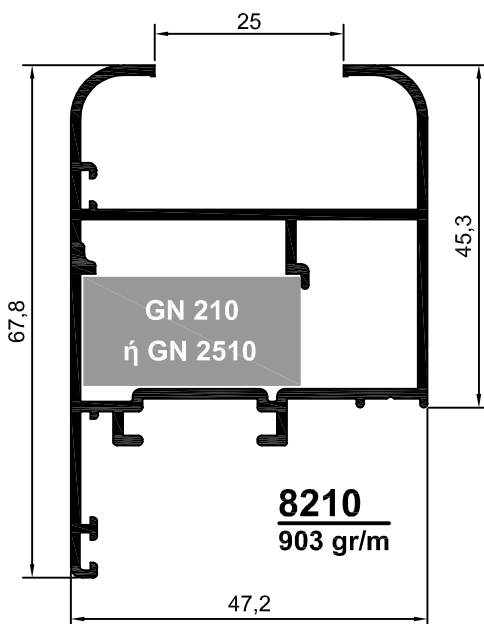
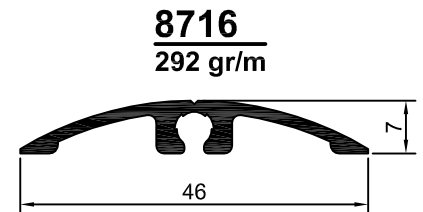
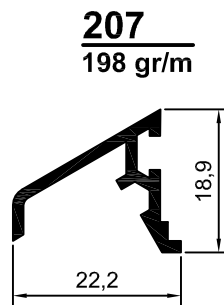
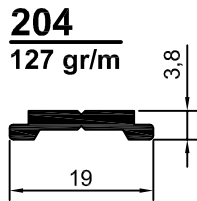
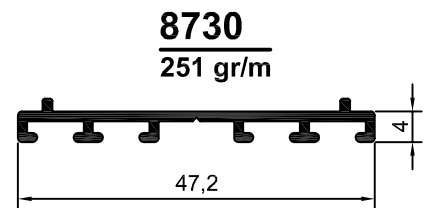
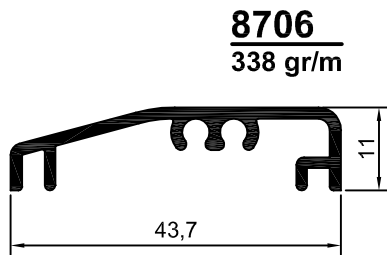
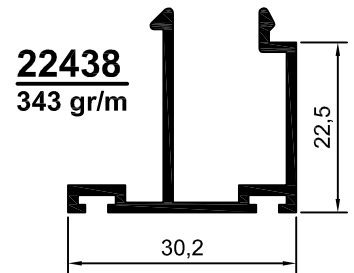
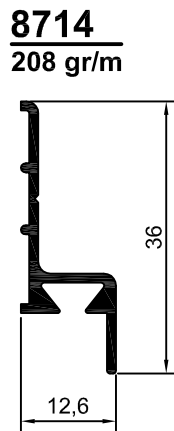
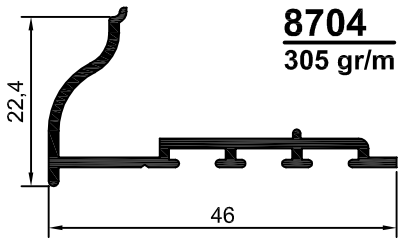

ΠΡΟΦΙΛ 1:1
profiles 1:1

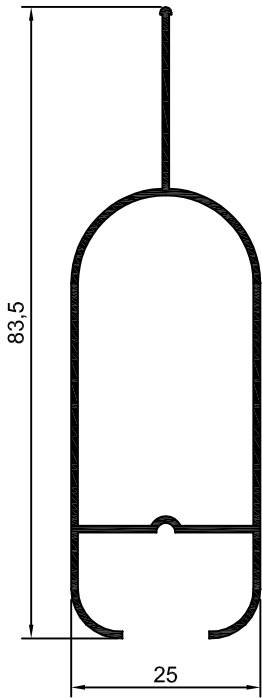

25520
406 gr/m

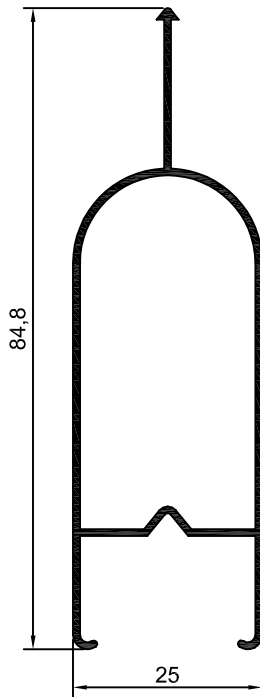

25523
467 gr/m

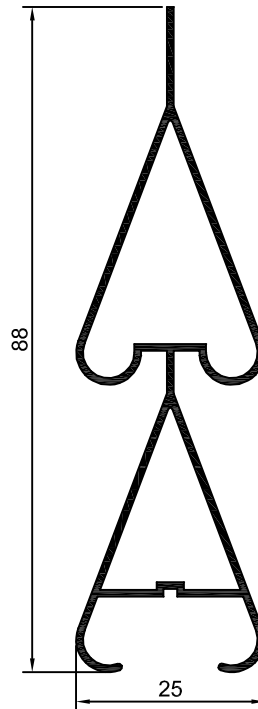

25521
553 gr/m

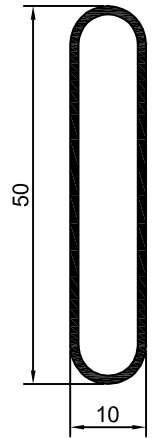

10x50
322 gr/m

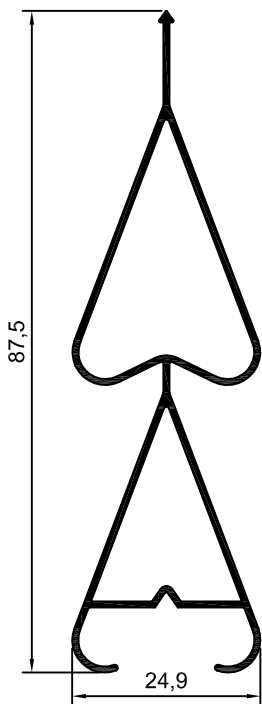

25521A
483 gr/m

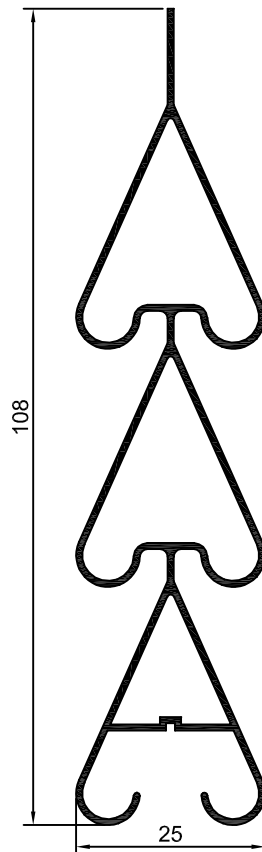

25529
682 gr/m

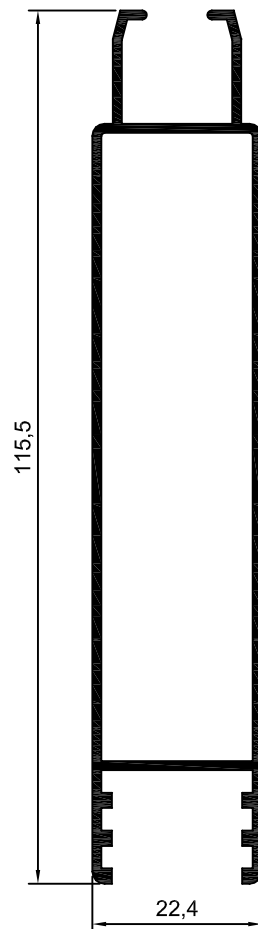

25351
933 gr/m

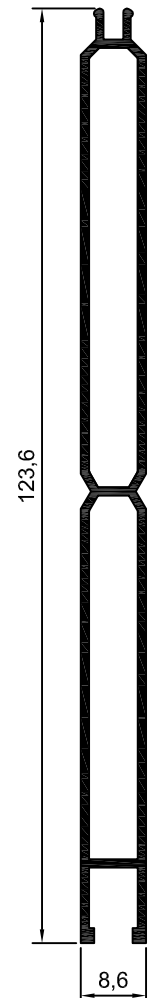

9700
790 gr/m

TOMEΣ 1:1
sections 1:1

ΔΙΦΥΛΛΟ ΑΝΟΙΓΟΑΝΑΚΛΙΝΟΜΕΝΟ
double frame tilt & turn window

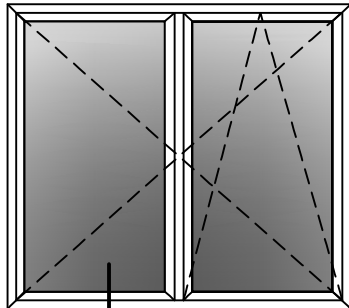

1

TOMH 1
section 1

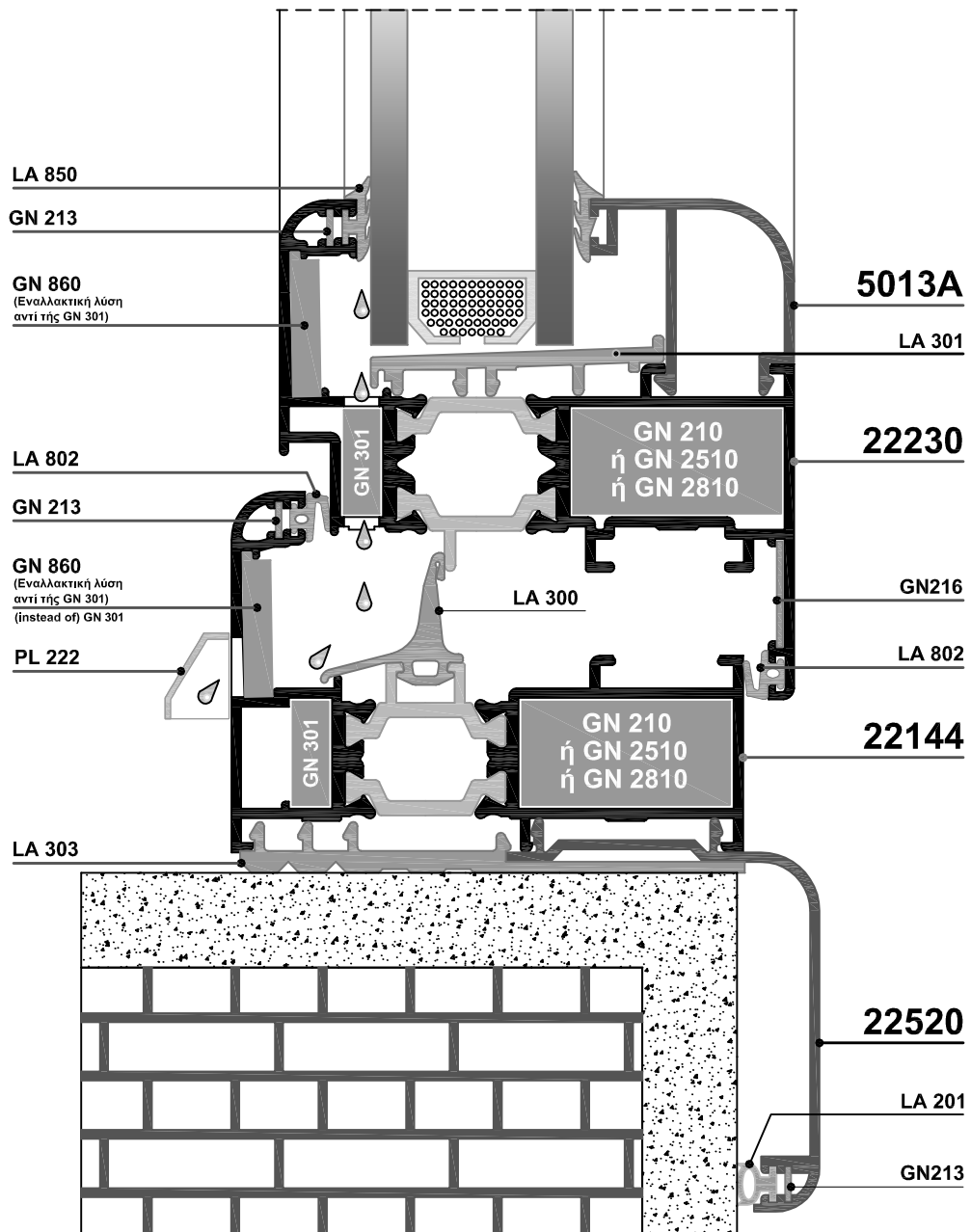

TOMEΣ 1:1
sections 1:1

ΔΙΦΥΛΛΟ ΑΝΟΙΓΟΑΝΑΚΛΙΝΟΜΕΝΟ
double frame tilt & turn window

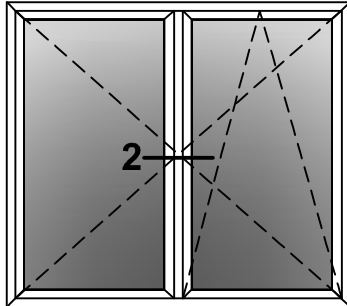

TOMH 2
section 2

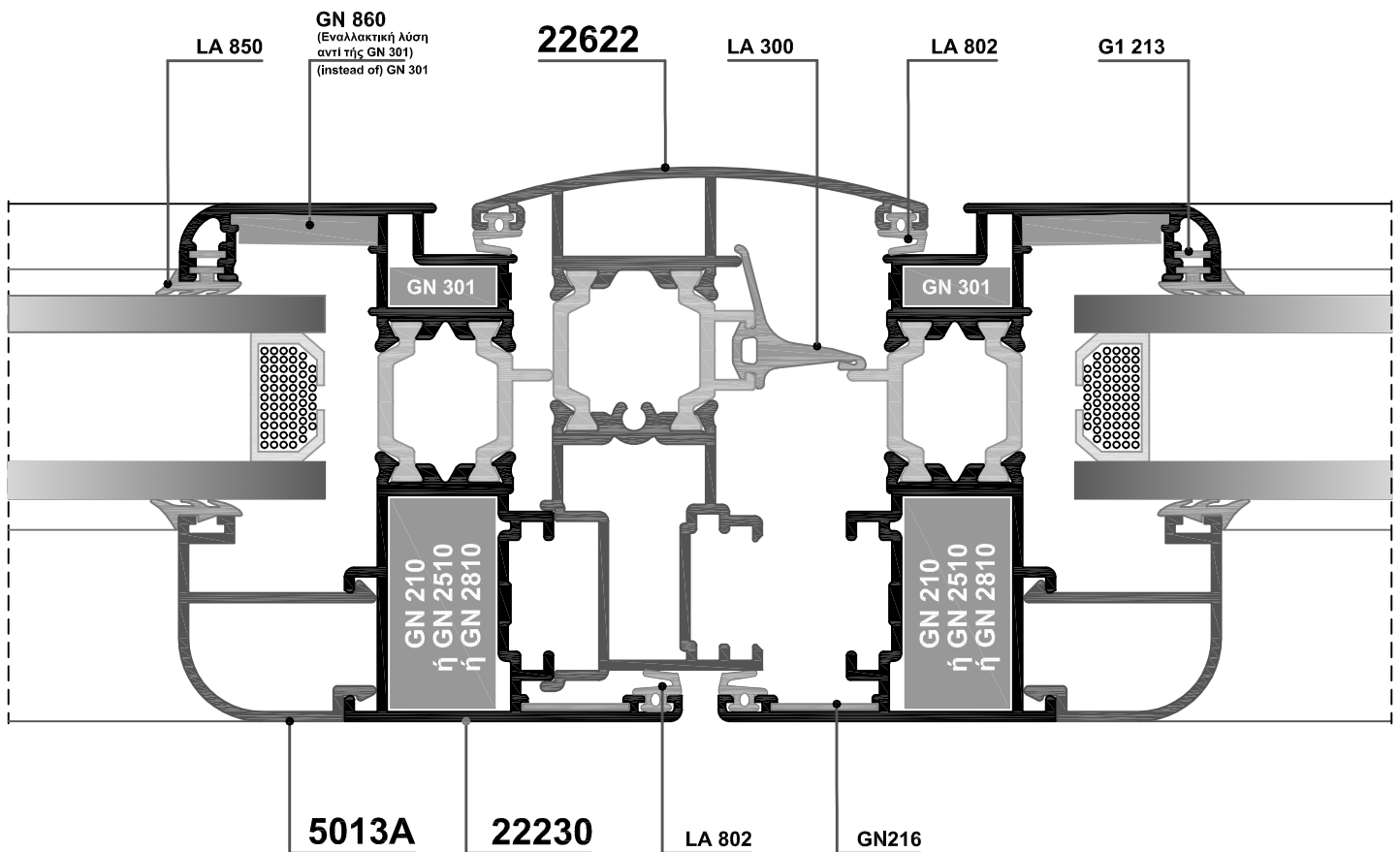

**ΔΙΦΥΛΛΟ ΑΝΟΙΓΘΑΝΑΚΛΙΝΟΜΕΝΟ
ΜΕ ΠΕΡΙΜΕΤΡΙΚΟ ΜΗΧΑΝΙΣΜΟ**
**double frame tilt & turn window
with multilock mechanism**

**TOMEΣ 1:1
sections 1:1**

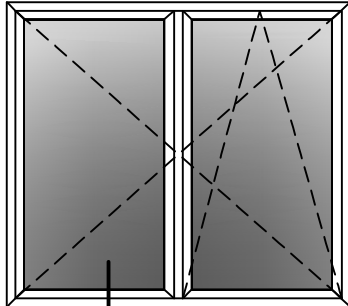

1

**TOMH 1
section 1**

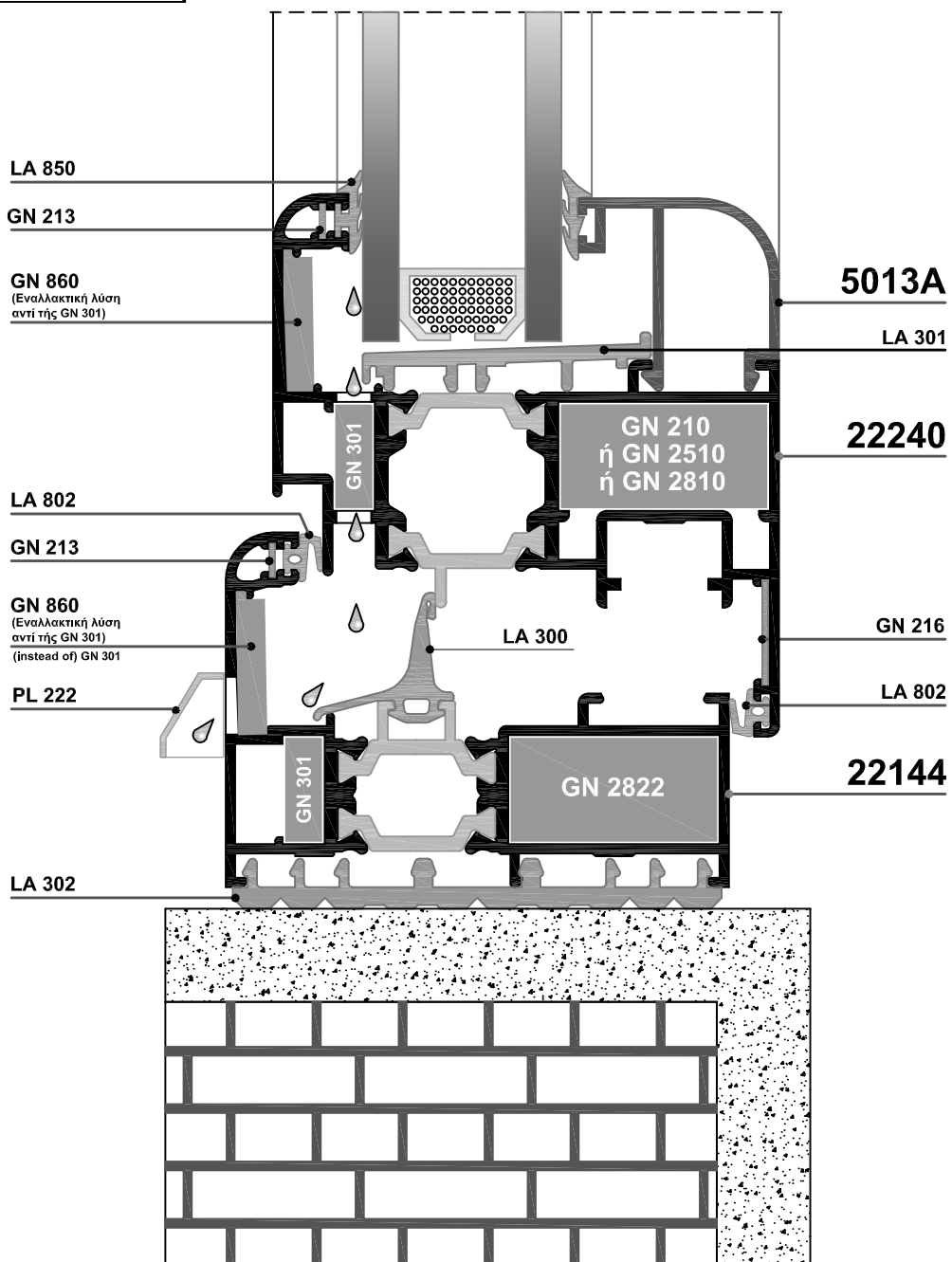

**ΔΙΦΥΛΛΟ ΑΝΟΙΓΘΑΝΑΚΛΙΝΟΜΕΝΟ
ΜΕ ΠΕΡΙΜΕΤΡΙΚΟ ΜΗΧΑΝΙΣΜΟ**
**double frame tilt & turn window
with multilock mechanism**

**TOMEΣ 1:1
sections 1:1**

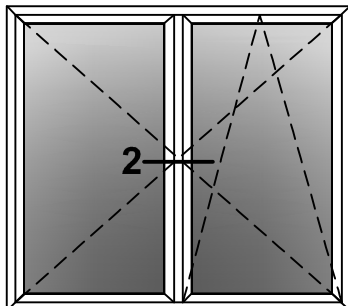

**TOMH 2
section 2**

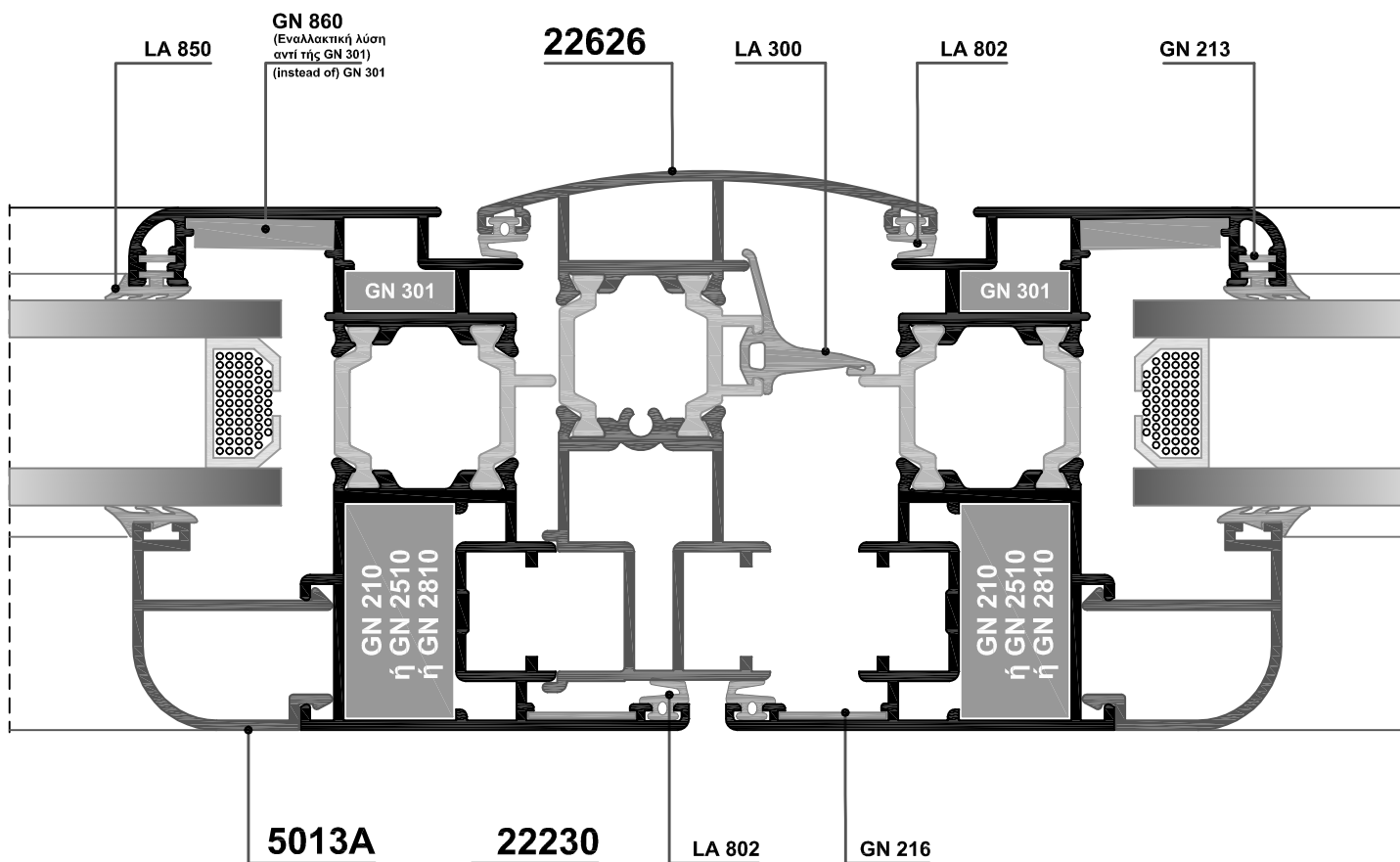

**ΔΙΦΥΛΛΗ ΜΠΑΛΚΟΝΟΠΟΡΤΑ
TZAMI - ΠΑΝΤΖΟΥΡΙ
ΜΕ ΕΝΙΑΙΑ ΚΑΣΑ**
double frame tilt & turn window
with shutters using a compact
outer frame

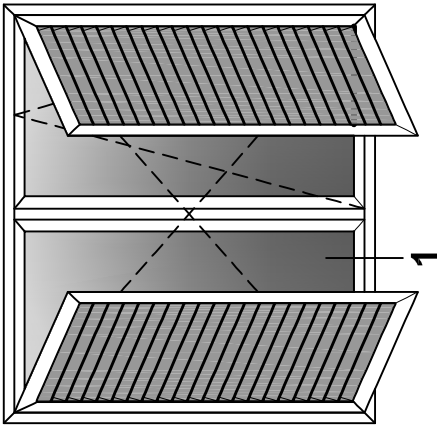

**TOMH 1
section 1**

**TOMEΣ 1:1
sections 1:1**

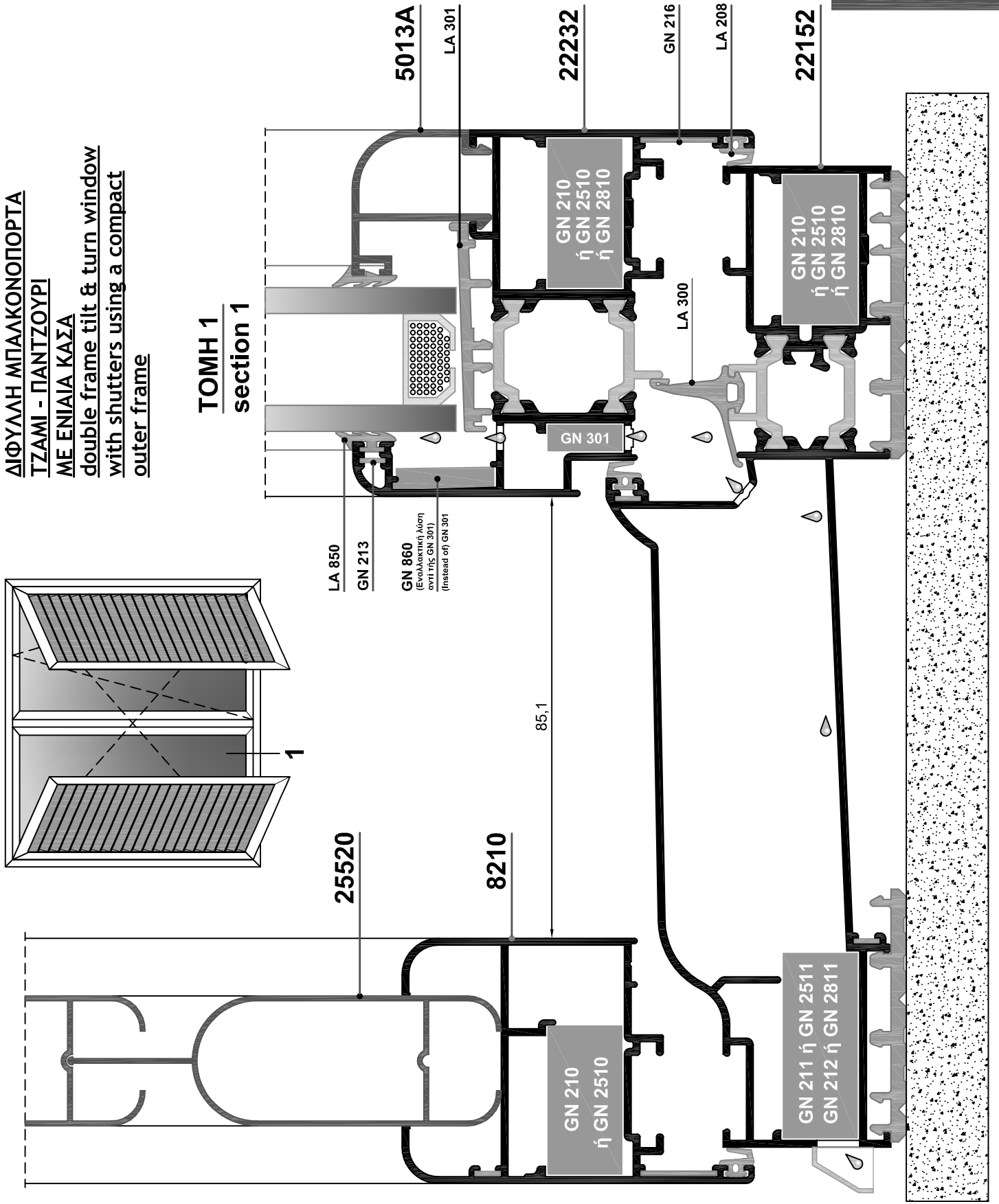

TOMEΣ 1:1
sections 1:1

TOMH 2
section 2

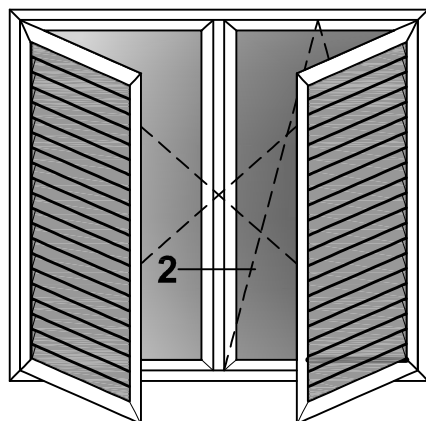
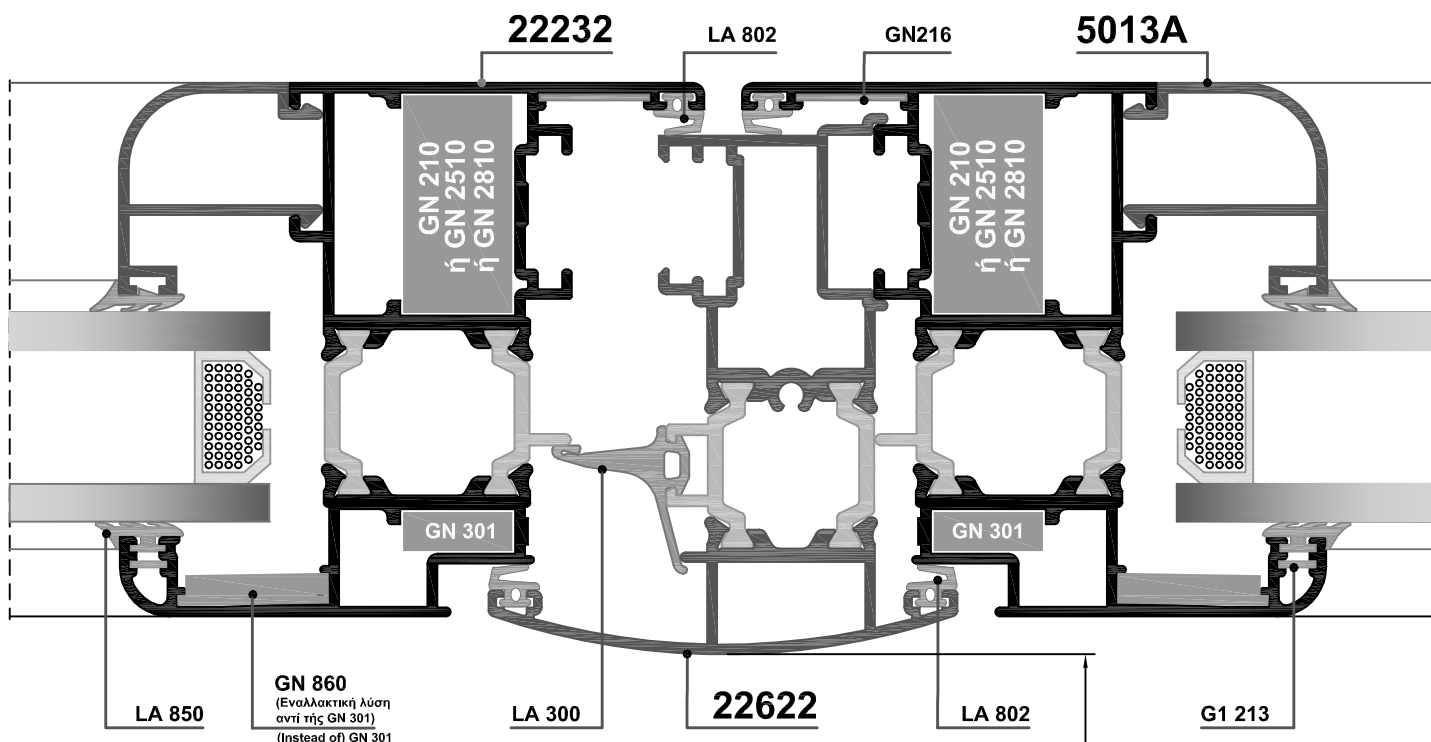

ΔΙΦΥΛΛΗ ΜΠΑΛΚΟΝΟΠΟΡΤΑ
ΤΖΑΜΙ - ΠΑΝΤΖΟΥΡΙ
ΜΕ ΕΝΙΑΙΑ ΚΑΣΑ
double frame tilt & turn window
with shutters using a compact
outer frame

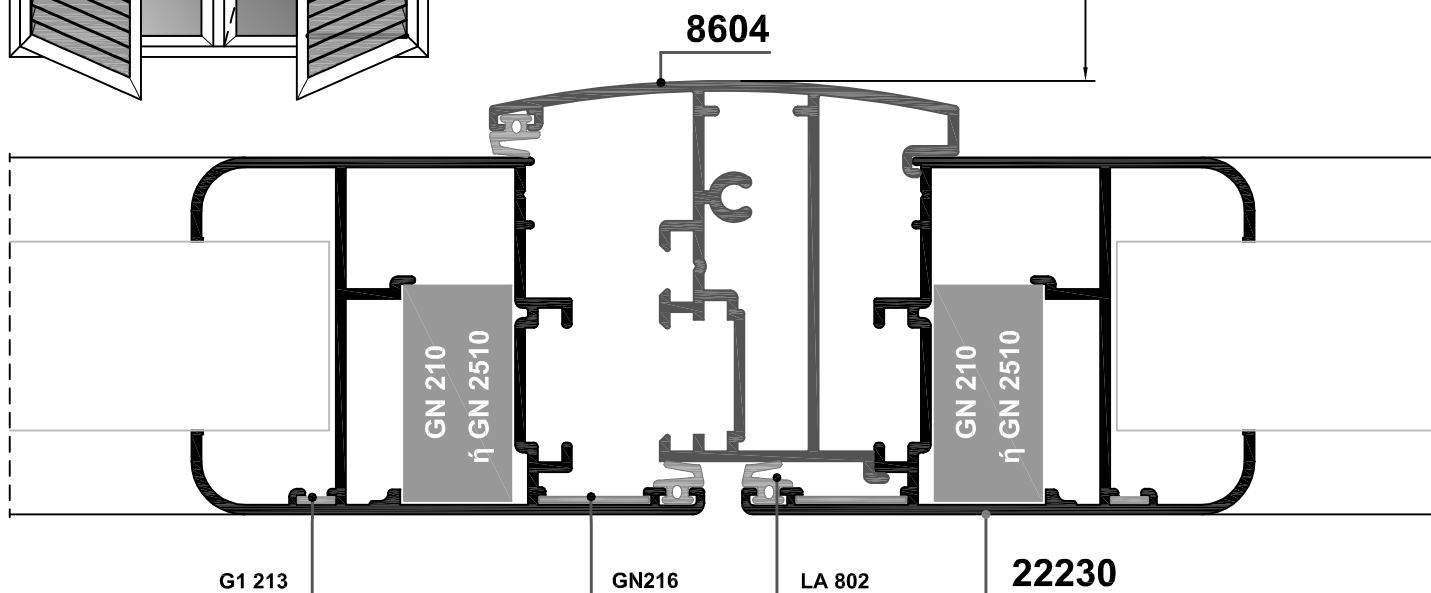

ΠΟΡΤΑ ΜΕ ΦΥΛΛΟ ΠΕΡΙΜΕΤΡΙΚΑ
door using a sash profile all around

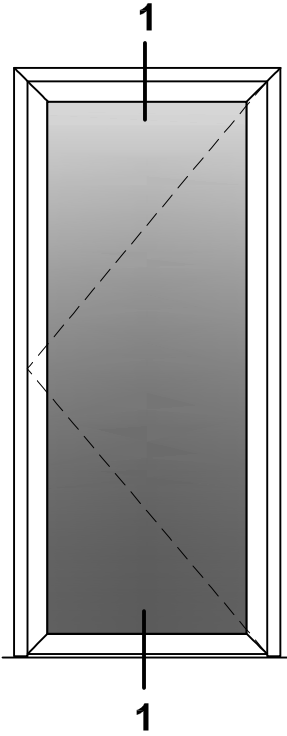

TOMH 1
section 1

TOMEΣ 1:1
sections 1:1

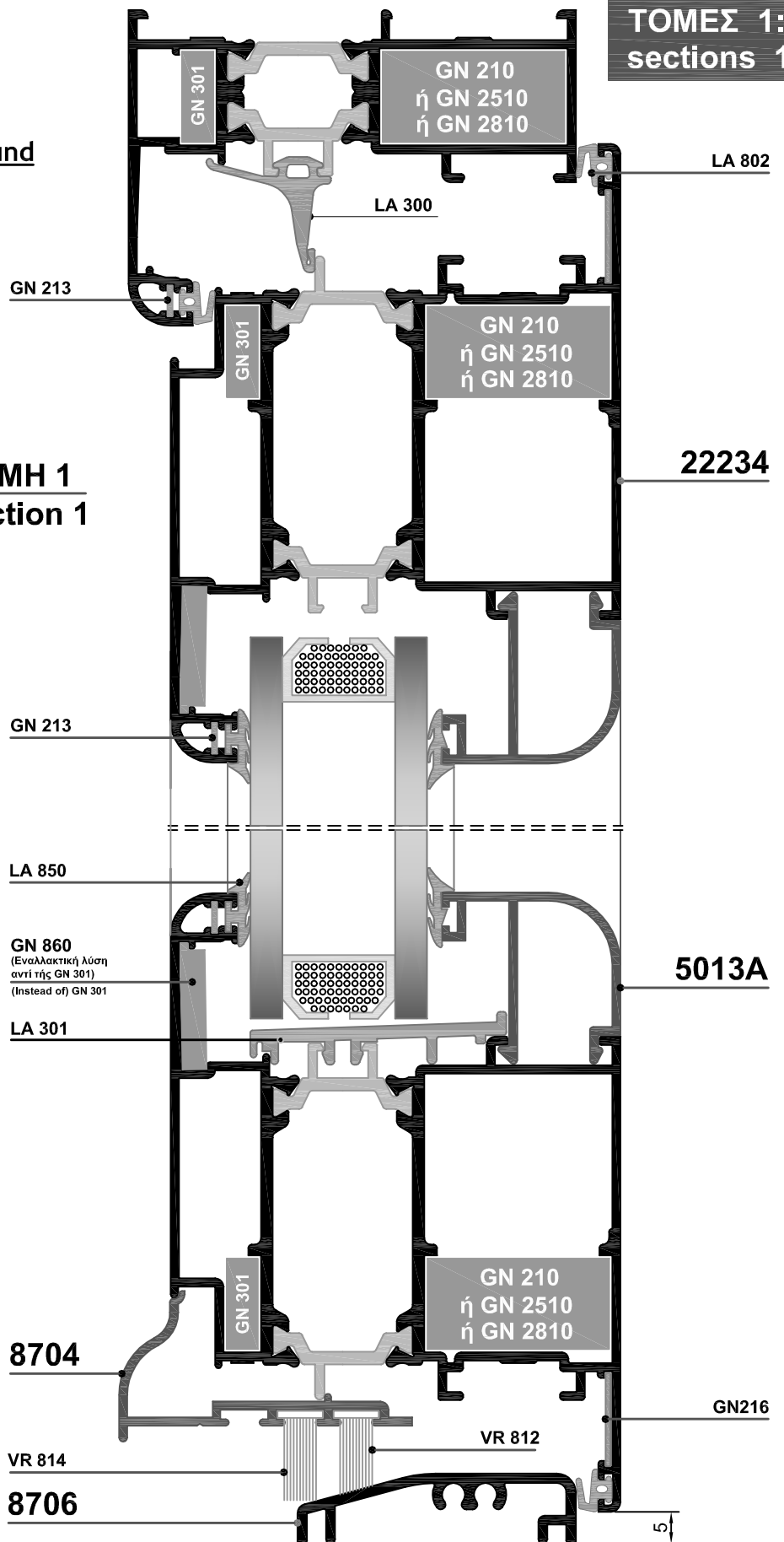

TOMEΣ 1:1
sections 1:1

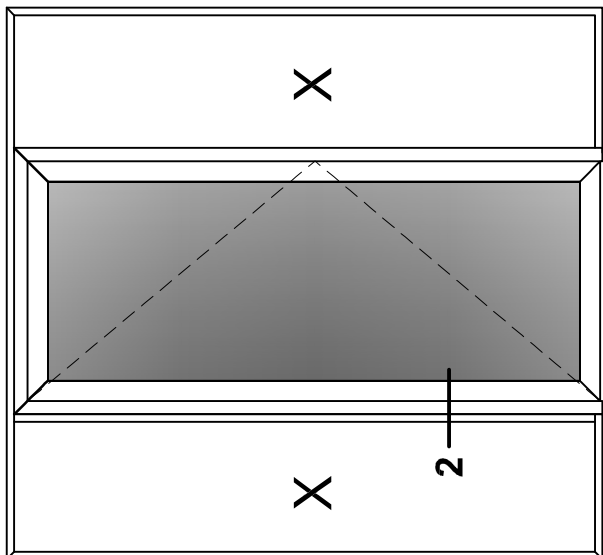

ΠΟΡΤΑ ΜΕ ΣΤΑΘΕΡΑ ΑΝΟΙΓΜΕΝΗ ΕΙΩ
door opening out with fixed frames

TOMH 2
section 2

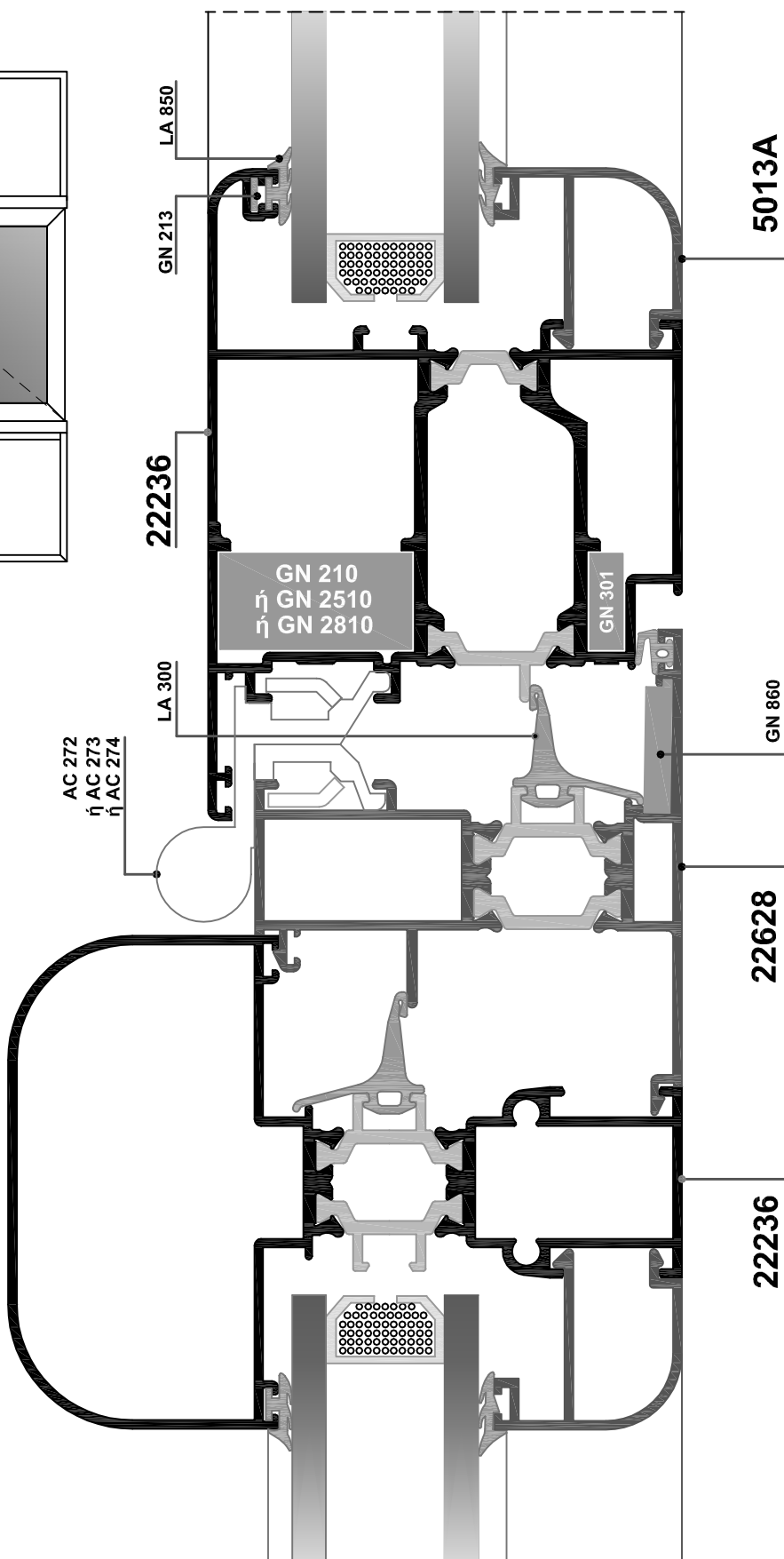

TOMEΣ ΣΤΕΓΑΝΩΣΗΣ ΘΥΡΩΝ
doors' sealing sections

TOMEΣ 1:1
sections 1:1

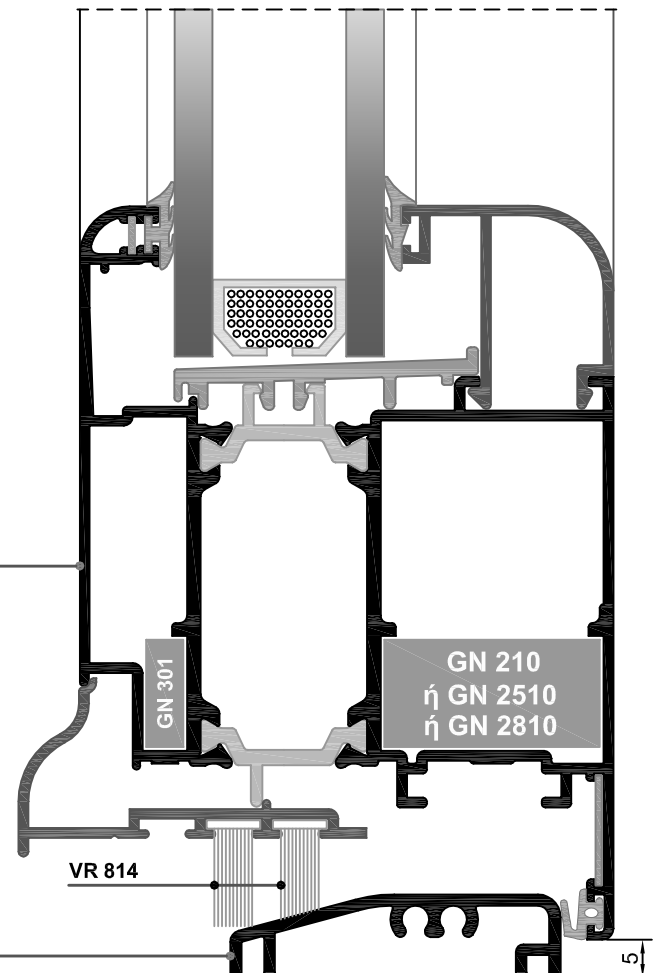
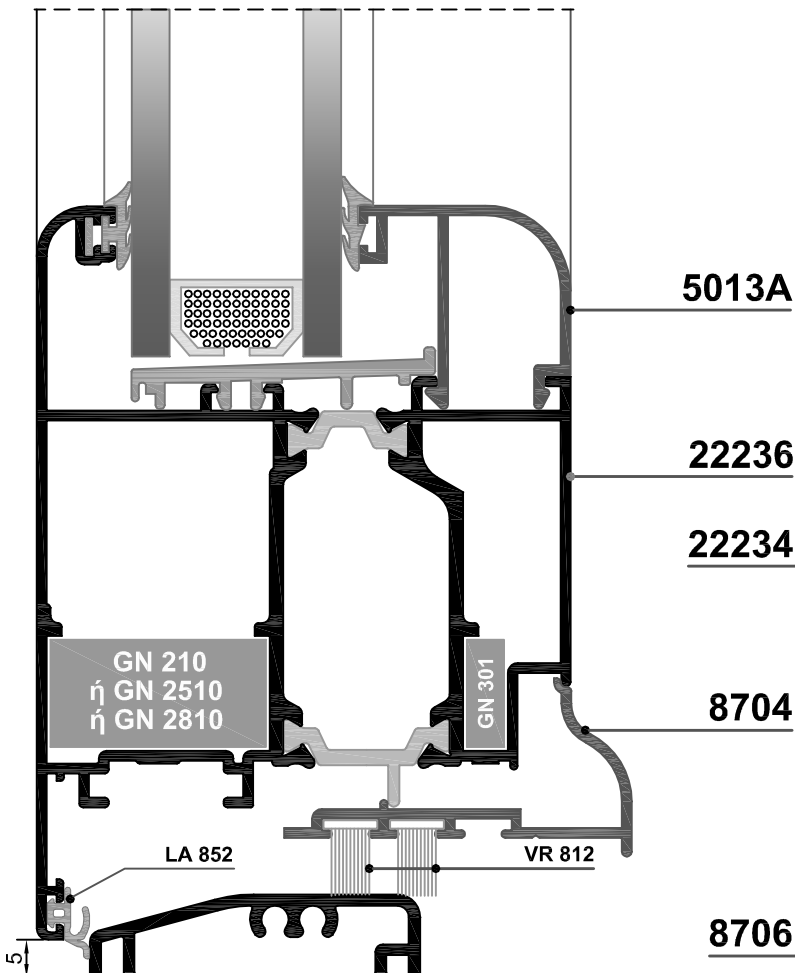
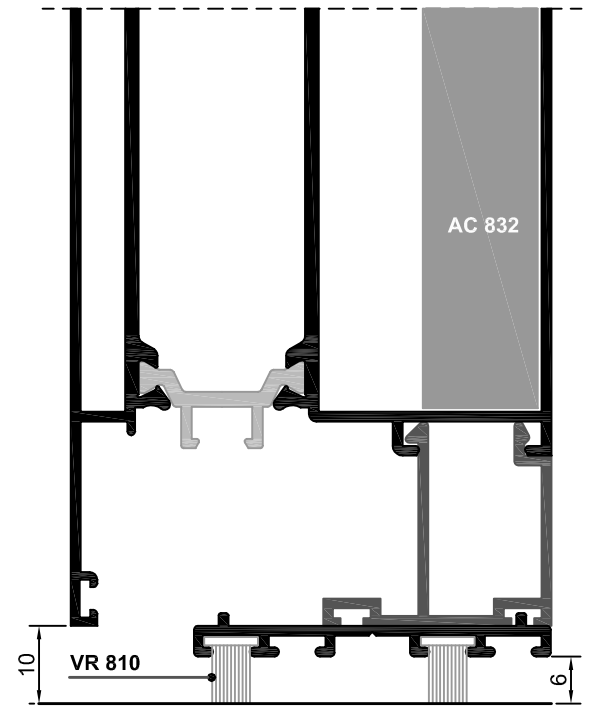
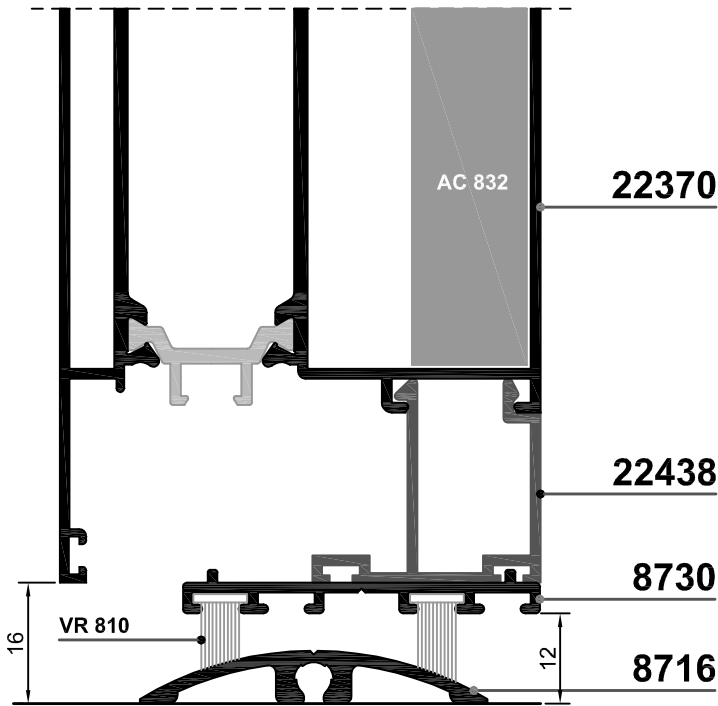

ΓΩΝΙΑΚΕΣ ΚΑΤΑΣΚΕΥΕΣ
Variable angle constructions

TOMEΣ 1:1
sections 1:1

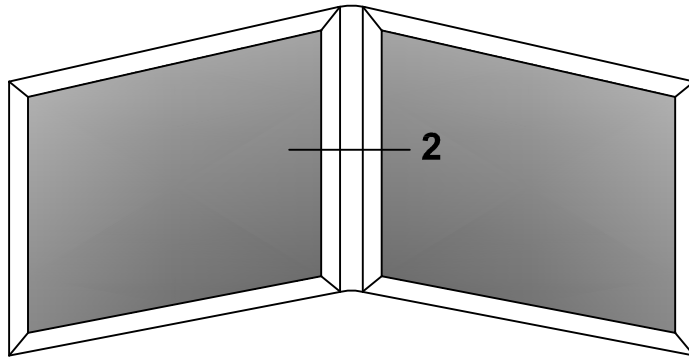

TOMH 2
section 2

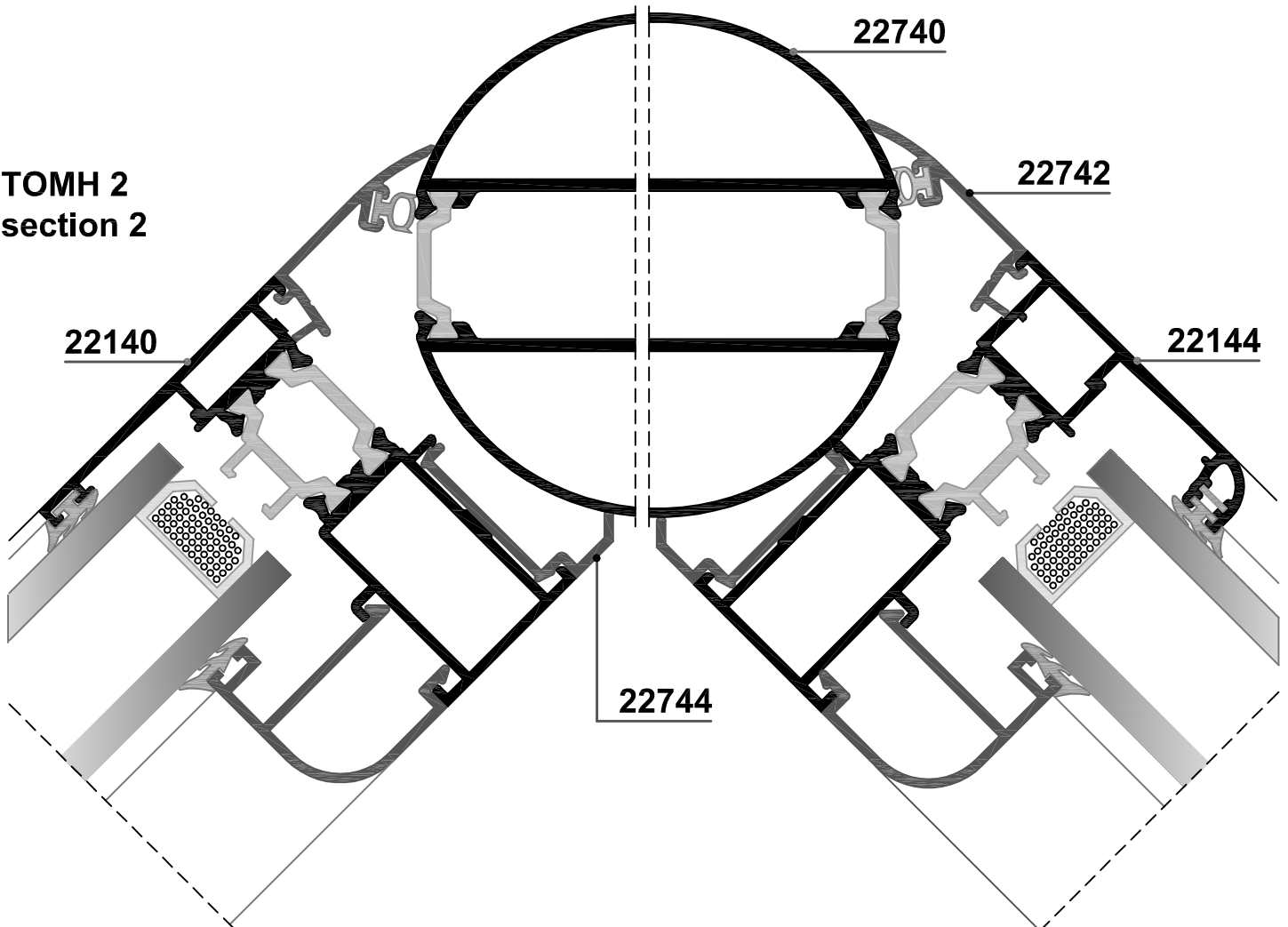

TOMES 1:2
sections 1:2

Αντικατάσταση ξύλινης μπαλκονόπορτας (τζάμι-ρολό)
με το σύστημα αντικατάστασης ΜΕΤΑΛΟΥΜΙΝ (τζάμι-σίτα -ρολό)

ΛΕΠΤΟΜΕΡΕΙΕΣ ΤΟΥ ΣΥΣΤΗΜΑΤΟΣ ΑΝΤΙΚΑΤΑΣΤΑΣΗΣ
ΚΑΙ ΟΙ ΠΕΡΙΠΤΩΣΕΙΣ ΠΟΥ ΚΑΛΥΠΤΕΙ, ΥΠΑΡΧΟΥΝ
ΣΤΟΝ ΚΑΤΑΛΟΓΟ "ΣΥΣΤΗΜΑ ΑΝΤΙΚΑΤΑΣΤΑΣΗΣ"

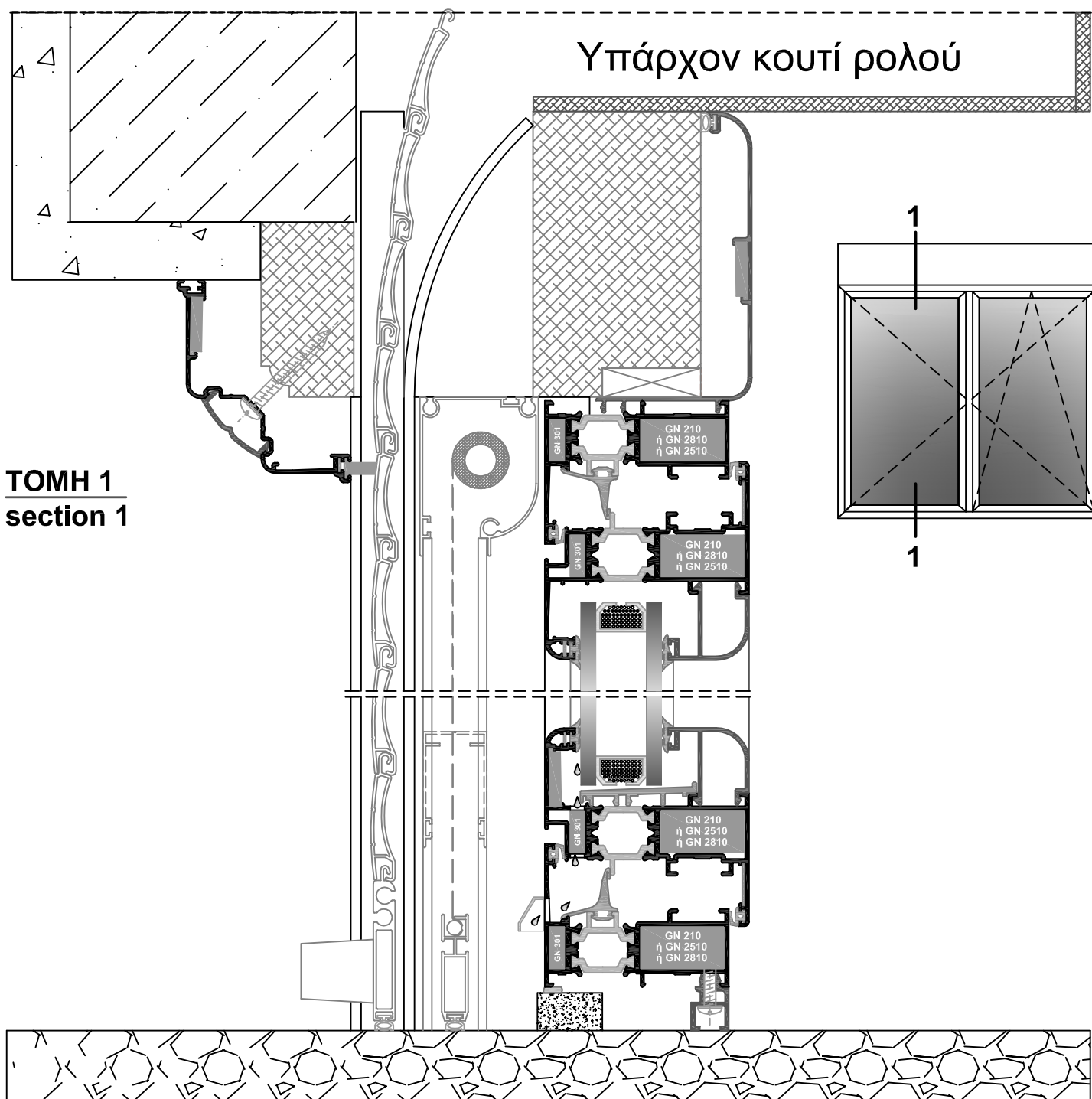

ΜΟΝΟΦΥΛΛΟ / single leaf

α. Ανοιγόμενο / swing-in

β. Ανοιγό/ανακλινόμενο / tilt & turn

γ. Με Περιμετρικό Κλείδωμα / multilocking

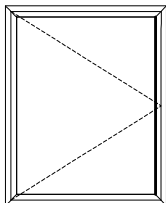

ΠΚ = ΠΛΑΤΟΣ ΚΑΣΑΣ
length of frame

ΥΚ = ΥΨΟΣ ΚΑΣΑΣ
height of frame

ΠΦ = ΠΛΑΤΟΣ ΦΥΛΛΟΥ
length of sash

ΥΦ = ΥΨΟΣ ΦΥΛΛΟΥ
height of sash

ΟΛΑ ΤΑ ΦΥΛΛΑ (all sashes)

ΜΕ ΚΑΣΑ 22140, 22144, 22148, 22150

$$\text{ΠΦ} = \text{ΠΚ} - 42$$

$$\text{ΥΦ} = \text{ΥΚ} - 42$$

ΜΕ ΚΑΣΑ 22142, 22146, 22152, 22154

$$\text{ΠΦ} = \text{ΠΚ} - 52,6$$

$$\text{ΥΦ} = \text{ΥΚ} - 52,6$$

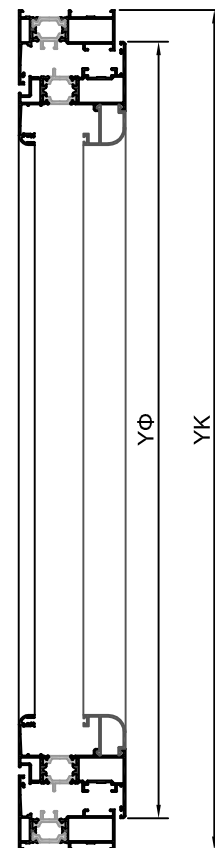
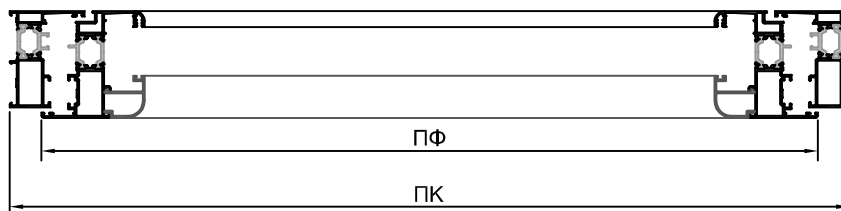

ΚΟΠΕΣ
cutting
instructions

ΔΙΦΥΛΛΟ / double leaf

α. Ανοιγόμενο / swing-in

β. Ανοιγό/ανακλινόμενο / tilt & turn

γ. Με Περιμετρικό Κλείδωμα / multilocking

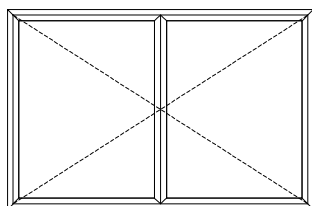

ΠΚ = ΠΛΑΤΟΣ ΚΑΣΑΣ
length of frame

ΥΚ = ΥΨΟΣ ΚΑΣΑΣ
height of frame

ΠΦ = ΠΛΑΤΟΣ ΦΥΛΛΟΥ
length of sash

ΥΦ = ΥΨΟΣ ΦΥΛΛΟΥ
height of sash

ΥΜ = ΥΨΟΣ ΜΠΙΝΙΟΥ
height of intermediate

ΟΛΑ ΤΑ ΦΥΛΛΑ (all sashes)

ΜΕ ΚΑΣΑ 22140, 22144, 22148, 22150

$$\text{ΠΦ} = (\text{ΠΚ} - 47) : 2$$

$$\text{ΥΦ} = \text{ΥΚ} - 42$$

$$\text{ΥΜ} = \text{ΥΚ} - 112,4$$

ΜΕ ΚΑΣΑ 22142, 22146, 22152, 22154

$$\text{ΠΦ} = (\text{ΠΚ} - 57,6) : 2$$

$$\text{ΥΦ} = \text{ΥΚ} - 52,6$$

$$\text{ΥΜ} = \text{ΥΚ} - 123$$

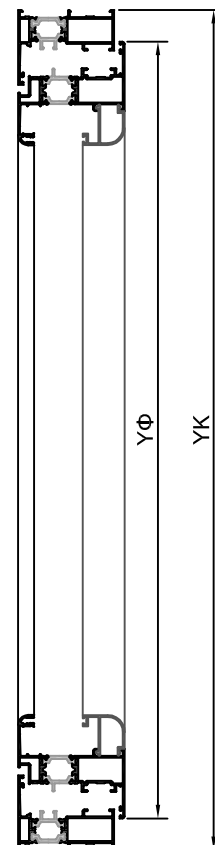
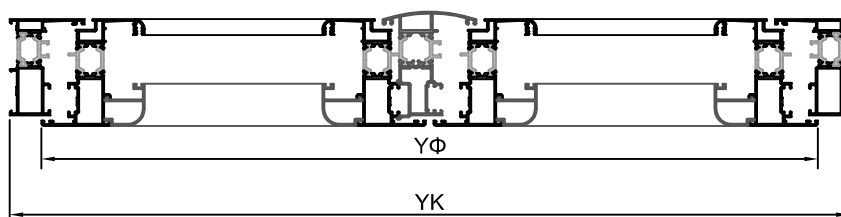

ΜΟΝΟΦΥΛΛΗ ΠΟΡΤΑ ΜΕ ΚΑΤΩΚΑΣΙ / single swing in-door

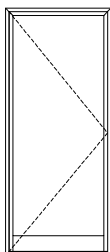

ΠΚ = ΠΛΑΤΟΣ ΚΑΣΑΣ
length of frame
ΥΚ = ΥΨΟΣ ΚΑΣΑΣ
height of frame
ΠΦ = ΠΛΑΤΟΣ ΦΥΛΛΟΥ
length of sash
ΥΦ = ΥΨΟΣ ΦΥΛΛΟΥ
height of sash

ΜΕ ΚΑΣΑ 22140, 22144, 22148, 22150

ΠΦ = ΠΚ - 42

ΥΦ = ΥΚ - 37

ΜΕ ΚΑΣΑ 22142, 22146, 22152, 22154

ΠΦ = ΠΚ - 52,6

ΥΦ = ΥΚ - 42,3



ΠΕΡΙΠΤΩΣΗ 1η

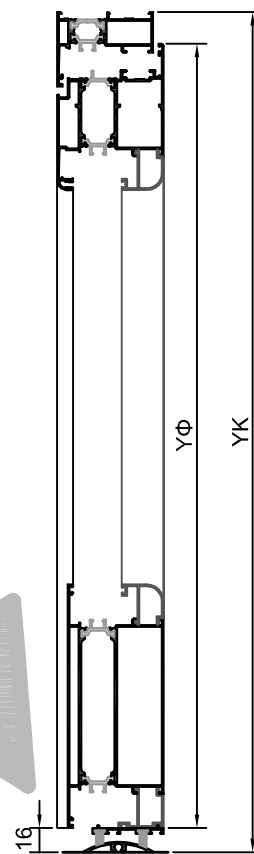
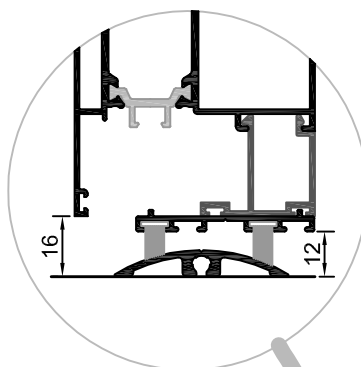

ΚΟΠΕΣ
cutting
instructions

ΜΟΝΟΦΥΛΛΗ ΠΟΡΤΑ ΧΩΡΙΣ ΚΑΤΩΚΑΣΙ / single swing in-door

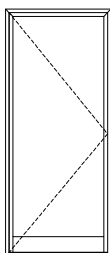

ΠΚ = ΠΛΑΤΟΣ ΚΑΣΑΣ
length of frame
ΥΚ = ΥΨΟΣ ΚΑΣΑΣ
height of frame
ΠΦ = ΠΛΑΤΟΣ ΦΥΛΛΟΥ
length of sash
ΥΦ = ΥΨΟΣ ΦΥΛΛΟΥ
height of sash

ΜΕ ΚΑΣΑ 22140, 22144, 22148, 22150

ΠΦ = ΠΚ - 42

ΥΦ = ΥΚ - 31

ΜΕ ΚΑΣΑ 22142, 22146, 22152, 22154

ΠΦ = ΠΚ - 52,6

ΥΦ = ΥΚ - 36,3



ΠΕΡΙΠΤΩΣΗ 2η

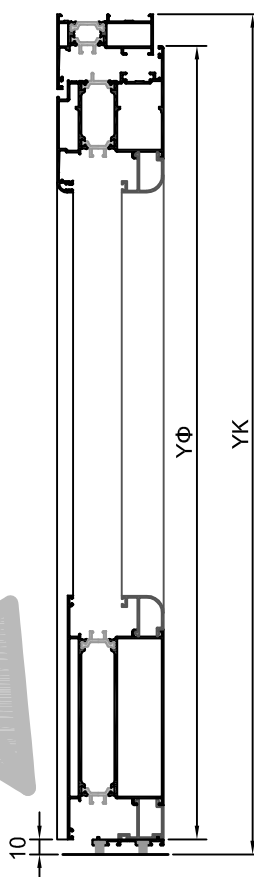
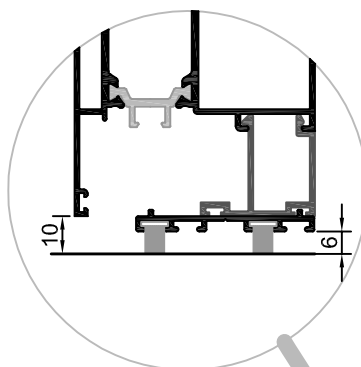

ΔΙΦΥΛΛΗ ΠΟΡΤΑ ΜΕ ΚΑΤΩΚΑΣΙ / double swing In-door

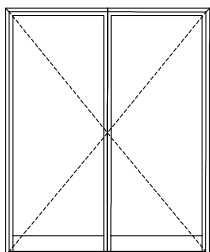

ΠΚ = ΠΛΑΤΟΣ ΚΑΣΑΣ
length of frame
ΥΚ = ΥΨΟΣ ΚΑΣΑΣ
height of frame
ΠΦ = ΠΛΑΤΟΣ ΦΥΛΛΟΥ
length of sash
ΥΦ = ΥΨΟΣ ΦΥΛΛΟΥ
height of sash
ΥΜ = ΥΨΟΣ ΜΠΙΝΙΟΥ
height of central adaptor

ΜΕ ΚΑΣΑ 22140, 22144, 22148, 22150

$$\text{ΠΦ} = (\text{ΠΚ} - 47) : 2$$

$$\text{ΥΦ} = \text{ΥΚ} - 37$$

$$\text{ΥΜ} = \text{ΥΚ} - 72,2$$

ΜΕ ΚΑΣΑ 22142, 22146, 22152, 22154

$$\text{ΠΦ} = (\text{ΠΚ} - 57,6) : 2$$

$$\text{ΥΦ} = \text{ΥΚ} - 42,3$$

$$\text{ΥΜ} = \text{ΥΚ} - 77,5$$

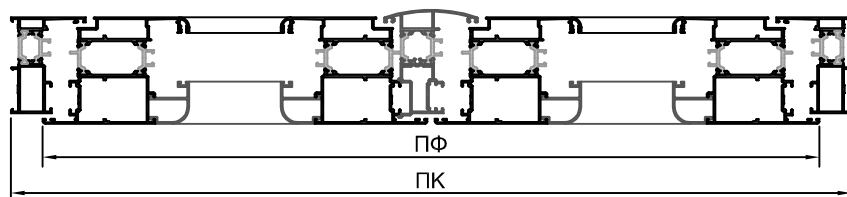

ΠΕΡΙΠΤΩΣΗ 1η

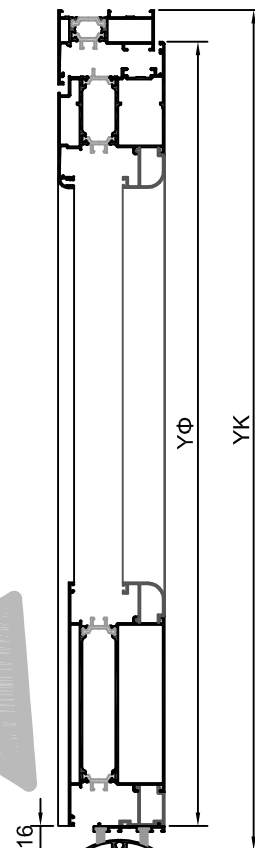
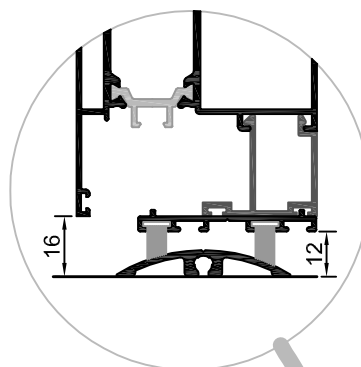

ΚΟΠΕΣ
cutting
instructions

ΔΙΦΥΛΛΗ ΠΟΡΤΑ ΧΩΡΙΣ ΚΑΤΩΚΑΣΙ / double swing In-door

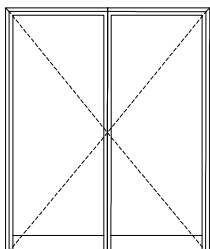

ΠΚ = ΠΛΑΤΟΣ ΚΑΣΑΣ
length of frame
ΥΚ = ΥΨΟΣ ΚΑΣΑΣ
height of frame
ΠΦ = ΠΛΑΤΟΣ ΦΥΛΛΟΥ
length of sash
ΥΦ = ΥΨΟΣ ΦΥΛΛΟΥ
height of sash
ΥΜ = ΥΨΟΣ ΜΠΙΝΙΟΥ
height of central adaptor

ΜΕ ΚΑΣΑ 22140, 22144, 22148, 22150

$$\text{ΠΦ} = (\text{ΠΚ} - 47) : 2$$

$$\text{ΥΦ} = \text{ΥΚ} - 31$$

$$\text{ΥΜ} = \text{ΥΚ} - 66,2$$

ΜΕ ΚΑΣΑ 22142, 22146, 22152, 22154

$$\text{ΠΦ} = (\text{ΠΚ} - 57,6) : 2$$

$$\text{ΥΦ} = \text{ΥΚ} - 36,3$$

$$\text{ΥΜ} = \text{ΥΚ} - 71,5$$

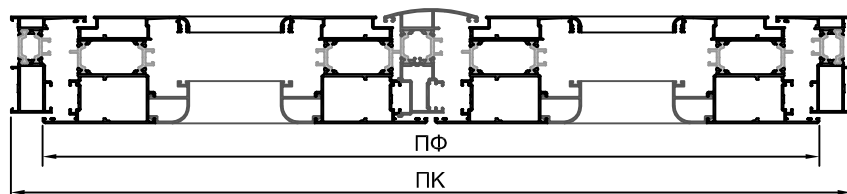

ΠΕΡΙΠΤΩΣΗ 2η

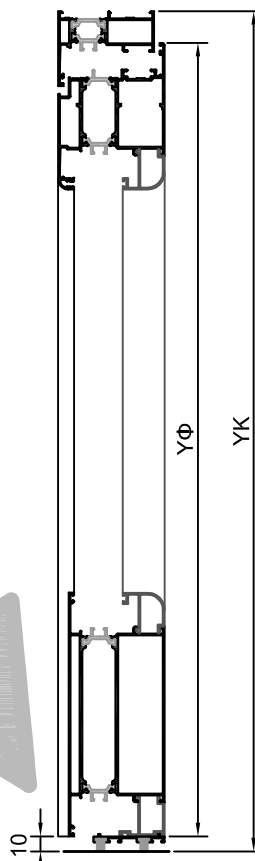
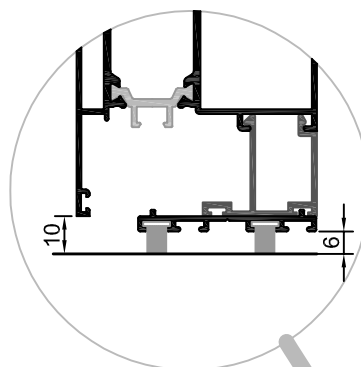



ΜΟΝΟΦΥΛΛΗ ΠΟΡΤΑ ΜΕ ΦΥΛΛΟ ΠΕΡΙΜΕΤΡΙΚΑ/ single swing In-door

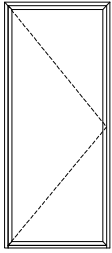

ΠΚ = ΠΛΑΤΟΣ ΚΑΣΑΣ
 length of frame
 ΥΚ = ΥΨΟΣ ΚΑΣΑΣ
 height of frame
 ΠΦ = ΠΛΑΤΟΣ ΦΥΛΛΟΥ
 length of sash
 ΥΦ = ΥΨΟΣ ΦΥΛΛΟΥ
 height of sash

ΜΕ ΚΑΣΑ 22140, 22144, 22148, 22150

ΠΦ = ΠΚ - 42

ΥΦ = ΥΚ - 26

ΜΕ ΚΑΣΑ 22142, 22146, 22152, 22154

ΠΦ = ΠΚ - 52,6

ΥΦ = ΥΚ - 31,3



ΠΕΡΙΠΤΩΣΗ 3η

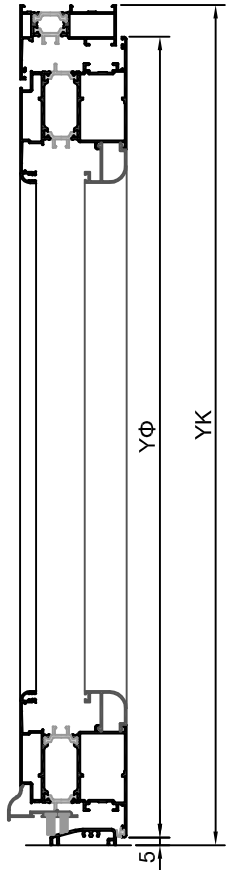
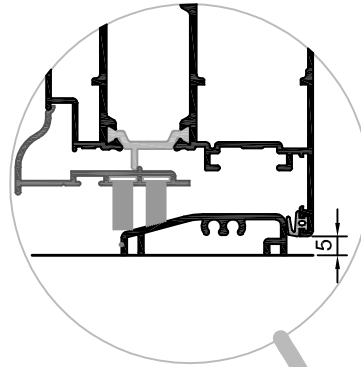

ΚΟΠΕΣ
cutting
instructions

ΜΟΝΟΦΥΛΛΗ ΜΠΑΛΚΟΝΟΠΟΡΤΑ ΜΕ ΕΝΣΩΜΑΤΩΜΕΝΟ ΠΑΝΤΖΟΥΡΙ single tilt & turn door with shutters

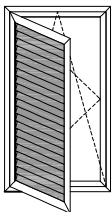

ΠΚ = ΠΛΑΤΟΣ ΚΑΣΑΣ
 length of frame
 ΥΚ = ΥΨΟΣ ΚΑΣΑΣ
 height of frame
 ΠΦ = ΠΛΑΤΟΣ ΦΥΛΛΟΥ
 length of sash
 ΥΦ = ΥΨΟΣ ΦΥΛΛΟΥ
 height of sash

ΜΕ ΚΑΣΑ 22152

ΠΦ = ΠΚ - 52,6

ΥΦ = ΥΚ - 52,6

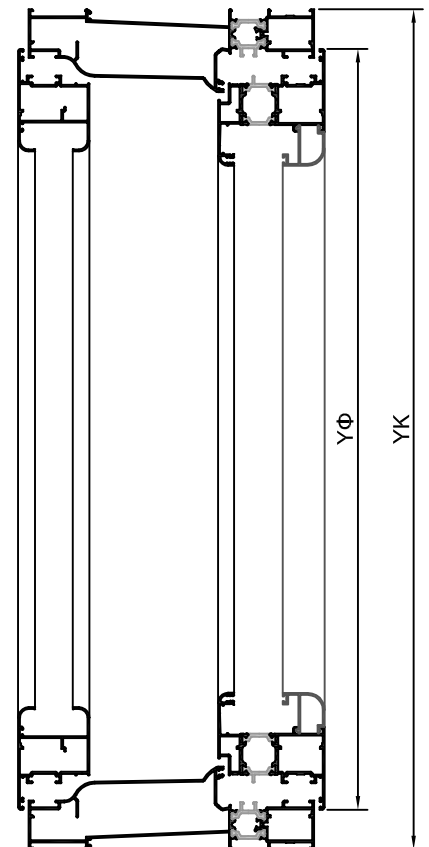
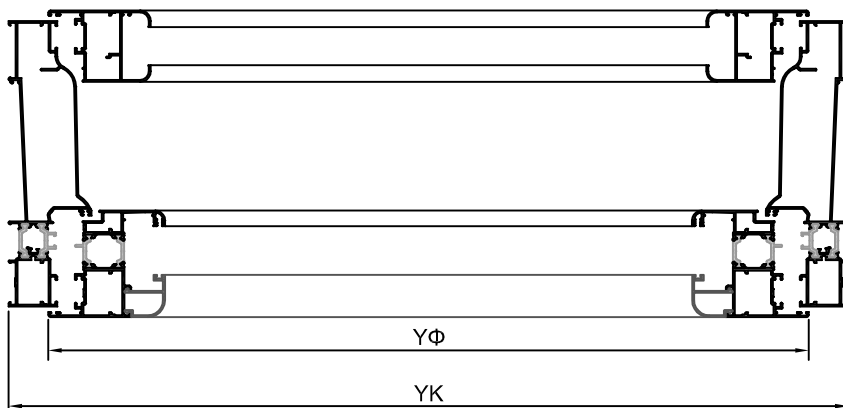

**ΔΙΦΥΛΛΗ ΜΠΑΛΚΟΝΟΠΟΡΤΑ
ΜΕ ΕΝΣΩΜΑΤΩΜΕΝΟ ΠΑΝΤΖΟΥΡΙ**
double tilt & turn door with shutters

ΜΕ ΚΑΣΑ 22152

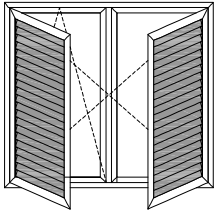

- ΠΚ = ΠΛΑΤΟΣ ΚΑΣΑΣ
length of frame
- ΥΚ = ΥΨΟΣ ΚΑΣΑΣ
height of frame
- ΠΦ = ΠΛΑΤΟΣ ΦΥΛΛΟΥ
length of sash
- ΥΦ = ΥΨΟΣ ΦΥΛΛΟΥ
height of sash
- ΥΜΦ = ΥΨΟΣ ΜΠΙΝΙΟΥ ΦΥΛΛΟΥ
height of sash intermediate
- ΥΜΠ = ΥΨΟΣ ΜΠΙΝΙΟΥ ΠΑΝΤΖΟΥΡΙΟΥ
height of shutter's central adaptor

$$\text{ΠΦ} = (\text{ΠΚ} - 57,6) : 2$$

$$\text{ΥΦ} = \text{ΥΚ} - 52,6$$

$$\text{ΥΜΦ} = \text{ΥΚ} - 123$$

$$\text{ΥΜΠ} = \text{ΥΚ} - 124,8$$

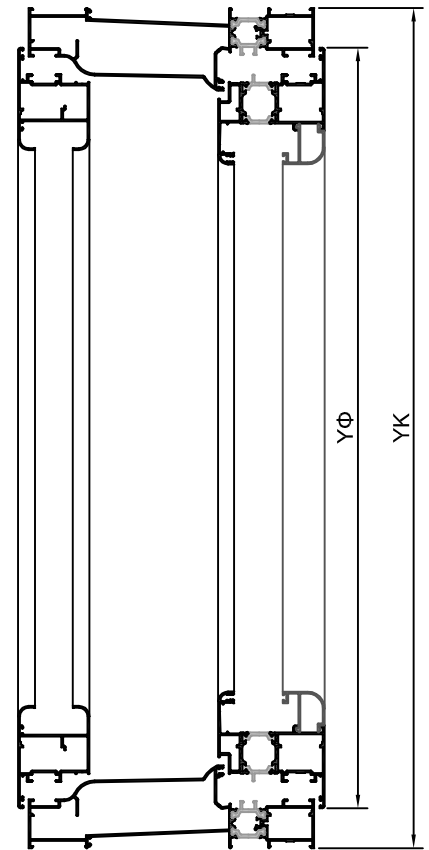
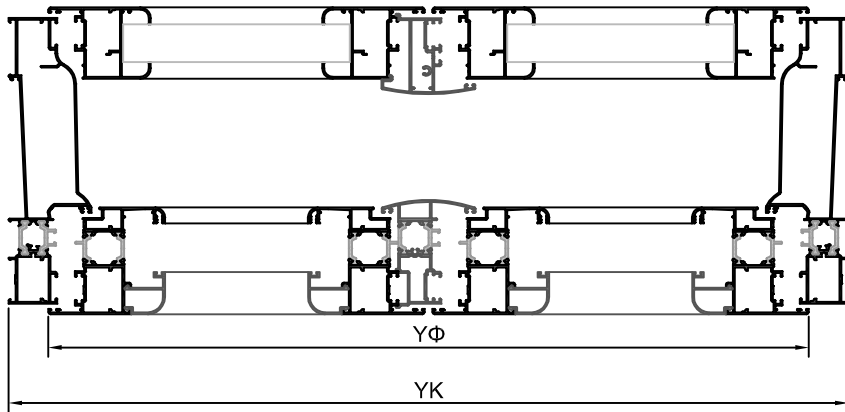

ΚΟΠΕΣ
cutting
instructions

ΤΥΠΟΠΟΙΗΣΗ CAMERA EUROPEA
camera europea standarbization

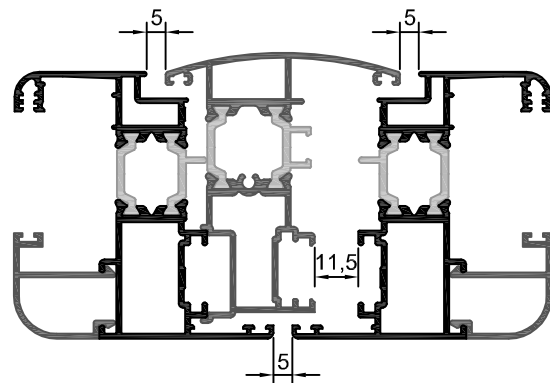
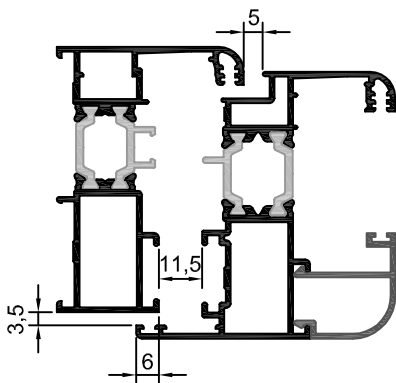

GN 210

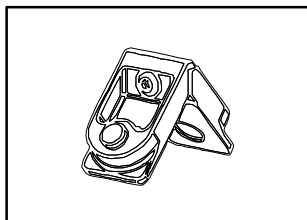

ΓΩΝΙΑ ΣΥΝΔΕΣΗΣ ΧΥΤΗ
ΓΙΑ ΟΛΑ ΤΑ ΠΡΟΦΙΛ

cast corner bracket
for all profiles

GN 2510

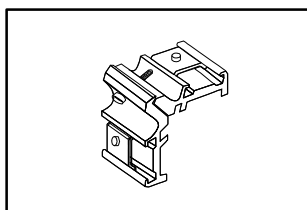

ΓΩΝΙΑ ΣΥΝΔΕΣΗΣ
ΑΛΟΥΜΙΝΙΟΥ
ΓΙΑ ΟΛΑ ΤΑ ΠΡΟΦΙΛ

aluminium corner bracket
for all profiles

GN 211

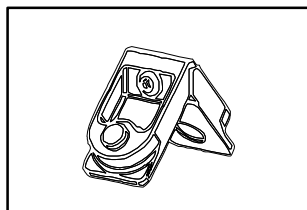

ΓΩΝΙΑ ΣΥΝΔΕΣΗΣ ΧΥΤΗ
ΓΙΑ 22152 (ΕΞΩΤ. ΤΜΗΜΑ)

cast corner bracket
for 22152

GN 2511

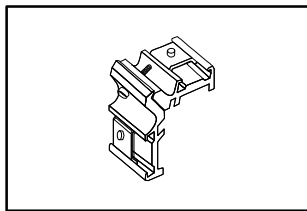

ΓΩΝΙΑ ΣΥΝΔΕΣΗΣ
ΑΛΟΥΜΙΝΙΟΥ
ΓΙΑ 22152 (ΕΞΩΤ. ΤΜΗΜΑ)

aluminium corner bracket
for 22152

GN 212

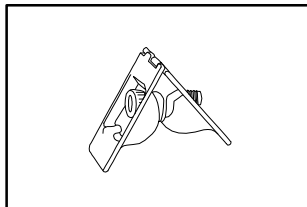

ΓΩΝΙΑ ΣΥΝΔΕΣΗΣ
ΓΙΑ ΟΛΕΣ ΤΙΣ ΚΑΣΕΣ

two piece corner
bracket for all casements

GN 860

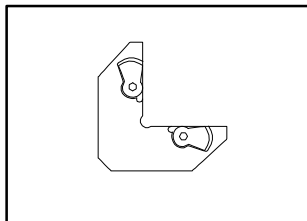

ΕΝΑΛΛΑΚΤΙΚΗ ΓΩΝΙΑ ΣΥΝΔΕΣΗΣ / ΕΥΘΥΓΡΑΜΜΙΣΗΣ ΓΙΑ 22140, 22142, 22144, 22146, 22154, 22230, 22232, 22234, 22238, 22240, 8504, 8506

cast corner bracket for 22140, 22142, 22144, 22146, 22154, 22230, 22232, 22234, 22238, 22240, 8504, 8506

ΓΩΝΙΑ ΓΩΝΙΑΣΤΡΑΣ
ΓΙΑ ΟΛΑ ΤΑ ΠΡΟΦΙΛ

corner cleat
for all profiles

GN 2810

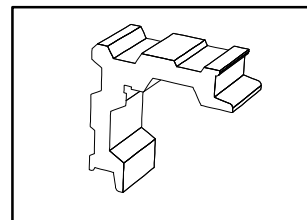

ΓΩΝΙΑ ΓΩΝΙΑΣΤΡΑΣ
ΠΕΡΙΜΕΤΡΙΚΟΥ ΓΙΑ
22140, 22144, 2148, 22150

corner cleat for
multilock mechanism
22140, 22144, 2148, 22150

GN 2822

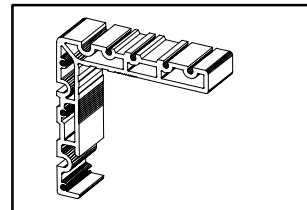

ΓΩΝΙΑ ΓΩΝΙΑΣΤΡΑΣ
ΠΕΡΙΜΕΤΡΙΚΟΥ ΓΙΑ 22142,
22146, 22149, 22152,
22154

corner cleat for
multilock mechanism for
22142, 22146, 22149,
22152, 22154

GN 2233

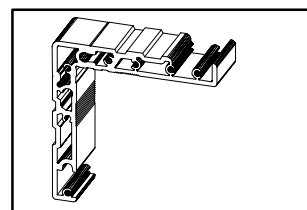

ΓΩΝΙΑ ΓΩΝΙΑΣΤΡΑΣ
ΓΙΑ 22152 (ΕΞΩΤ. ΤΜΗΜΑ)

corner cleat for 22152

GN 2811

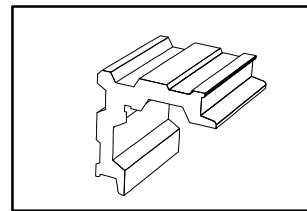

ΓΩΝΙΑ ΓΩΝΙΑΣΤΡΑΣ
ή ΜΕ ΚΑΒΙΛΙΑ

corner cleat for cotter pin

GN 301

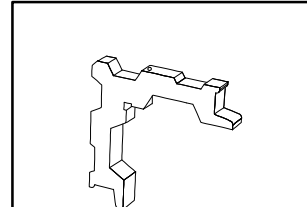

ΚΑΒΙΛΙΑ ΓΙΑ
ΓΩΝΙΑ ΣΥΝΔΕΣΗΣ GN 301

cotter pin for aluminium
corner bracket GN 301

AC 302

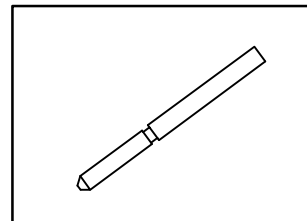

GN 213

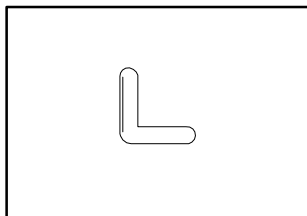

ΓΩΝΙΑ ΕΠΙΠΕΔΟΤΗΤΑΣ
ΓΑΛΒΑΝΙΖΕ 5 mm

alignment corner 5 mm

GN 214

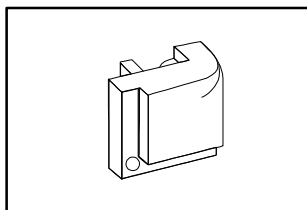

ΓΩΝΙΑ ΚΑΜΠΥΛΩΤΗ
ΓΙΑ ΠΗΧΑΚΙ

cast corner piece
for curved glazing
beads

AC 242

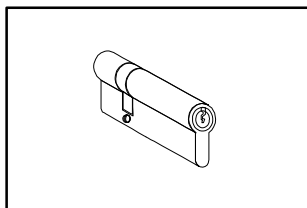

ΚΥΛΙΝΔΡΟΣ ΚΛΕΙΔΑΡΙΑΣ
95 mm

lock cylinder 95 mm

AC 235

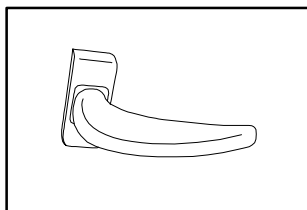

ΠΟΜΟΛΟ ΜΟΝΟ

lever handle single

AC 241

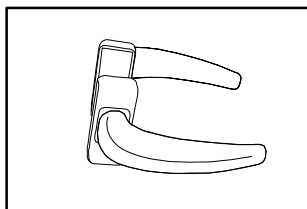

ΠΟΜΟΛΟ ΔΙΠΛΟ

lever handle double

AC 232

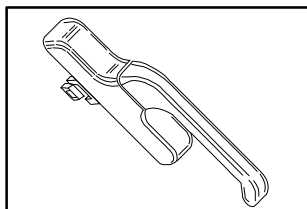

ΣΠΑΝΙΟΛΕΤΑ
ΜΗΧΑΝΙΣΜΟΥ

handle for tilt and
turn mechanism

GN 216

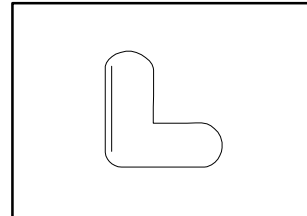

ΓΩΝΙΑ ΕΠΙΠΕΔΟΤΗΤΑΣ
ΓΑΛΒΑΝΙΖΕ 15 mm

alignment corner 15 mm

AC 236

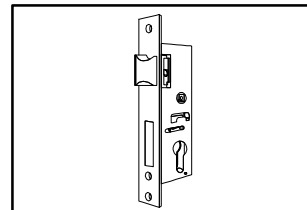

ΚΛΕΙΔΑΡΙΑ ΑΝΟΙΓΟΜΕΝΩΝ
35 mm
ΑΠΛΗ = AC 237
ΤΡΙΩΝ ΣΗΜΕΙΩΝ = AC 238

security lock for single
acting door
35 mm basket = AC 237
3 point lock = AC 238

AC 239

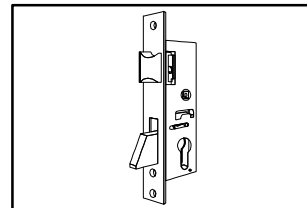

ΚΛΕΙΔΑΡΙΑ ΜΑΧΑΙΡΩΤΗ
35 mm

special deadbolt lock
35 mm

AC 295 AC 838

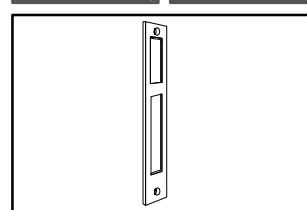

ΑΝΤΙΚΡΥΣΜΑ ΚΛΕΙΔΑΡΙΑΣ
ΑΠΛΗΣ = AC 295
3 ΣΗΜΕΙΩΝ = AC 838

striker plate
single lock AC 295
3 point lock = AC 838

AC 233

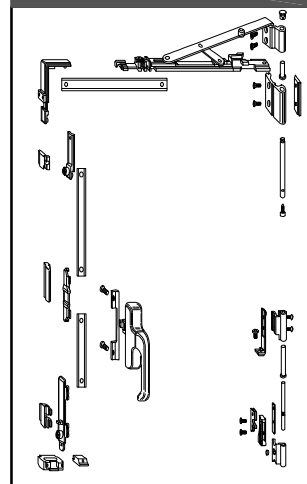

ΚΙΤ ΜΗΧΑΝΙΣΜΟΥ
ΑΝΑΚΛΙΣΗΣ (ΧΩΡΙΣ ΨΑΛΙΔΙ
ΚΑΙ ΣΠΑΝΙΟΛΕΤΑ)

tilt & turn mechanism
(projection arm &
spagnolette are not
included)

AC 251

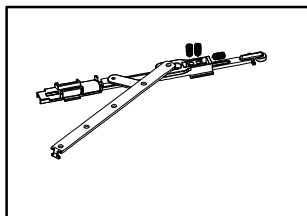

No 1 = AC 250
No 2 = AC 251

No 1 = AC 250
No 2 = AC 251

AC 291

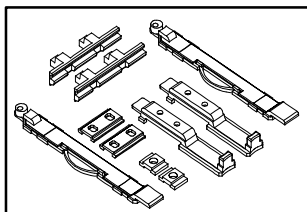

ΣΥΡΤΗΣ ΔΙΦΥΛΛΟΥ ΓΙΑ
ΜΗΧΑΝΙΣΜΟ ΑΝΑΚΛΙΣΗΣ

second frame latch for
tilt & turn mechanism

AC 230

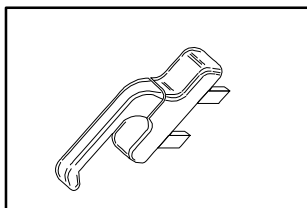

ΣΠΑΝΙΟΛΕΤΑ
ΑΝΟΙΓΟΜΕΝΟΥ

espagnolette
for glass door
or window

AC 231

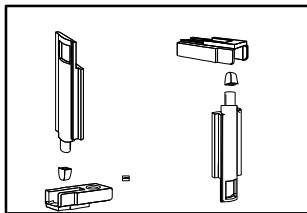

ΚΙΤ ΑΣΦΑΛΕΙΑΣ
ΣΠΑΝΙΟΛΕΤΑΣ
ΠΑΝΩ ΚΑΙ ΚΑΤΩ

security kit for the
upper & lower rod
of the espagnolette

AC 297

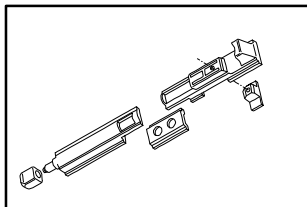

ΣΥΡΤΗΣ ΔΙΦΥΛΛΟΥ

second frame latch

AC 897

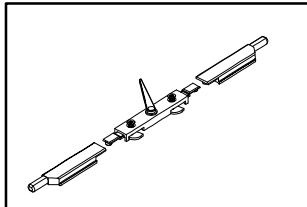

ΣΥΡΤΗΣ ΜΗΧΑΝΙΚΟΣ
ΜΕ ΛΕΒΙΕ

latch with lever

ΜΟΝΗ ΦΩΛΙΑ ΣΥΡΤΗ

rod striker

PL 224

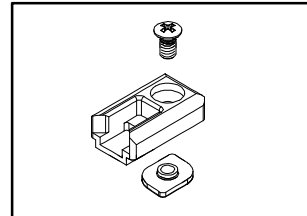

ΔΙΠΛΗ ΦΩΛΙΑ ΣΥΡΤΗ

double rod striker

PL 225

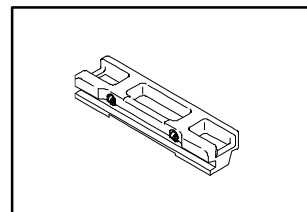

ΜΑΣΚΟΥΛΟΜΕΝΤΕΣΣΣ

90 mm = AC 272
120 mm = AC 273
180 mm = AC 274

aluminium hinge for
shutters

90 mm = AC 272
120 mm = AC 273
180 mm = AC 274

AC 272-273-274

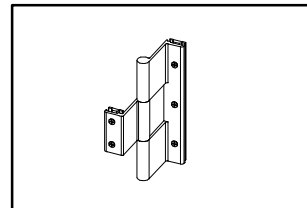

ΜΕΝΤΕΣΣΣ ΝΟΡΜΑΛ

standard aluminium
hinge

AC 276

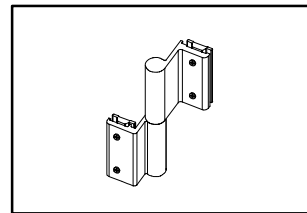

ΜΕΝΤΕΣΣΣ ΤΡΙΤΟΥ ΦΥΛΛΟΥ

aluminium hinge for
three leafcassment

AC 271

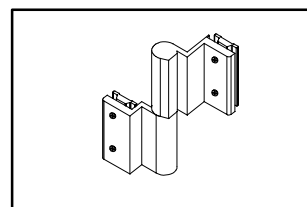

ΚΟΥΜΠΑΣΟ ΠΡΟΒΑΛΟΜΕΝΩΝ

one position limit arm
for projected vents

AC 252

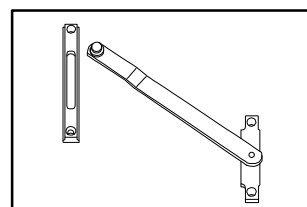

AC 253

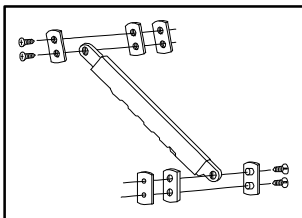

ΚΟΥΜΠΑΣΟ 5 ΘΕΣΕΩΝ
ΓΙΑ ΠΡΟΒΑΛΛΟΜΕΝΑ

5 stations arm for
projected vents

AC 255

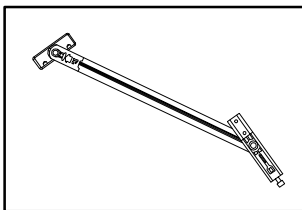

ΚΟΥΜΠΑΣΟ ΒΑΡΕΩΣ
ΤΥΠΟΥ ΜΕ STOP

heavy duty
projection arm

AC 290

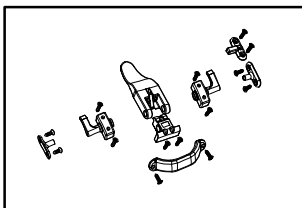

ΚΛΕΙΣΤΡΟ
ΠΑΝΤΖΟΥΡΟΒΕΡΓΑΣ

locker for
AC 293 or AC 294

AC 881

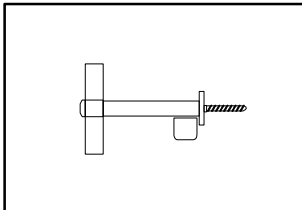

ΑΝΕΜΟΣΤΗΡΙΓΜΑ
ΑΠΛΟ ΜΟΝΟ

wind bracket (single)

AC 831

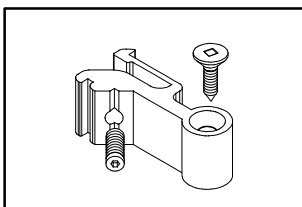

ΣΥΝΔΕΣΜΟΣ ΤΑΥ
(ανθρωπάκι)

connecting bracket

PL 870

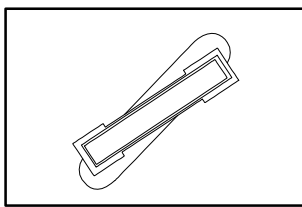

ΤΑΠΑ ΟΒΑΛΙΝΑΣ

plastic plug for blind

ΚΟΥΜΠΑΣΟΜΕΝΤΕΣΕΣ

bottom hung
window hinge

AC 254

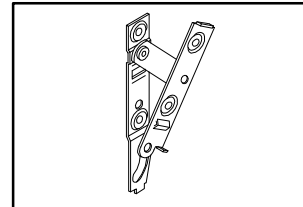

ΑΕΡΟΠΛΑΝΑΚΙ ΓΙΑ
ΦΕΓΓΙΤΕΣ ΚΑΙ ΜΙΚΡΑ
ΠΑΡΑΘΥΡΑ

aluminium safety latch
for lights or small size
windows

AC 234

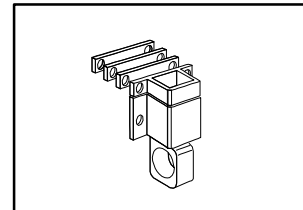

ΠΑΝΤΖΟΥΡΟΒΕΡΓΑ
1500 mm = AC 293
2400 mm = AC 294

shutter rod
1500 mm = AC 293
2400 mm = AC 294

AC 293 AC 294

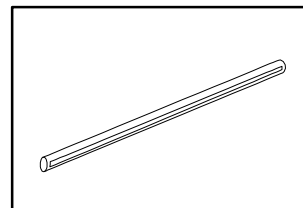

ΑΝΕΜΟΣΤΗΡΙΓΜΑ ΔΙΠΛΟ

wind bracket (double)

AC 882

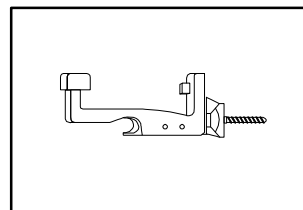

ΣΥΝΔΕΣΜΟΣ ΤΑΥ
ΓΙΑ 22370

connecting bracket
for 22370

AC 832

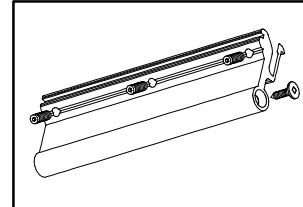

ΤΑΠΑ ΝΕΡΟΧΥΤΗ
ΦΥΛΛΟΥ(ΣΕΤ)

plug for sash water
deflector (set)

PL 306

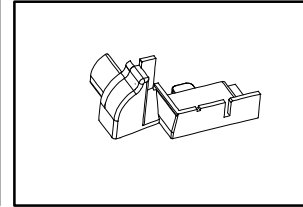

PL 222

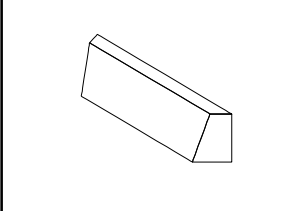

ΤΑΠΑ ΝΕΡΟΧΥΤΗ ΚΑΣΑΣ

plastic cover for outer frame drainage

GN 215



ΠΛΑΣΤΙΚΗ ΓΩΝΙΑ ΑΚΜΩΝ

plastic external corner cover for doors

PL 302

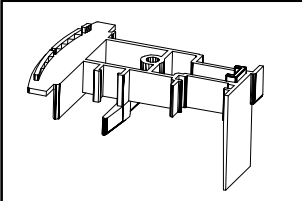

ΤΑΠΑ ΚΑΜΠΥΛΟΥ ΜΠΙΝΙΟΥ 22622

plastic plug for adaptor 22622 (set)

PL 304

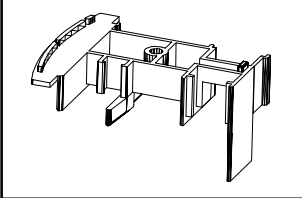

ΤΑΠΑ ΚΑΜΠΥΛΟΥ ΜΠΙΝΙΟΥ ΠΕΡΙΜΕΤΡΙΚΟΥ 22626 (ΣΕΤ)

plastic plug for adaptor 22626 (set)

PL 860

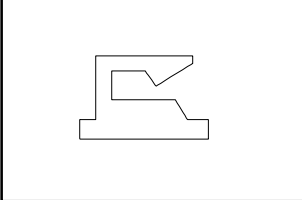

ΚΛΙΠ ΓΙΑ ΠΗΧΑΚΙ

clip for glazing bead

LA 802



ΛΑΣΤΙΧΟ "ΝΥΧΑΚΙ"

interior seal gasket

ΑΠΟΣΤΑΤΗΣ ΚΑΣΑΣ

Outer frame spacer

ΤΑΠΑ ΙΣΙΟΥ ΜΠΙΝΙΟΥ 22620 (ΣΕΤ)

plastic plug for adaptor 22620 (set)

ΤΑΠΑ ΜΠΙΝΙΟΥ ΠΕΡΙΜΕΤΡΙΚΟΥ 22624 (ΣΕΤ)

plastic plug for adaptor 22624 (set)

ΤΑΠΑ ΓΙΑ ΚΟΥΜΠΩΜΑ 8704 (ΣΕΤ)

plastic cover for water sealing profile 8704 (set)

ΠΡΟΦΙΛ ΥΔΑΤΟΣΤΕΓΑΝΩΣΗΣ

profile directing water out

ΛΑΣΤΙΧΟ ΤΖΑΜΙΟΥ ΚΟΥΜΠΩΤΟ

push-in glass gasket

PL 305

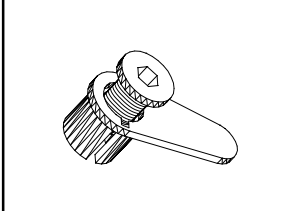

PL 301

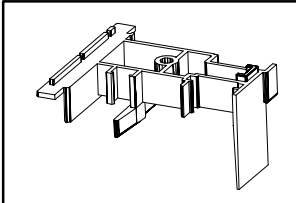

PL 303

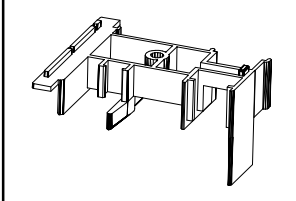

PL 223

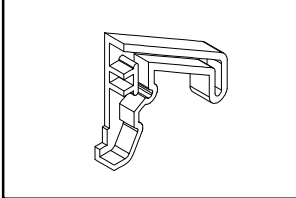

LA 301

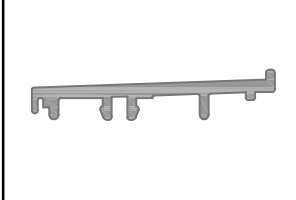

LA 850



LA 302

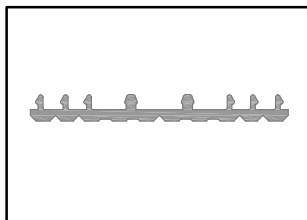

ΛΑΣΤΙΚΟ ΜΟΝΩΣΗΣ ΚΑΣΑΣ

Outer frame sealing gasket

LA 852

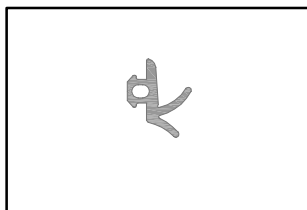

ΛΑΣΤΙΚΟ ΣΤΕΓΑΝΩΣΗΣ

Sealing gasket

LA 851

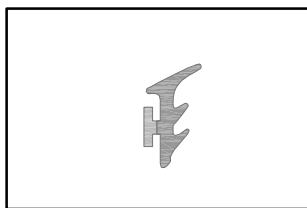

ΛΑΣΤΙΚΟ ΤΖΑΜΙΟΥ
ΜΕ ΣΚΛΗΡΗ ΒΑΣΗ

slide-in glass gasket
with hard base

VR 810

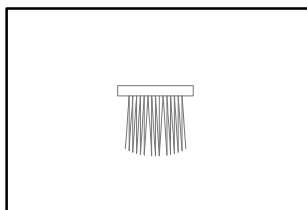

ΒΟΥΡΤΣΑΚΙ No 10

weather brush No 10

VR 812

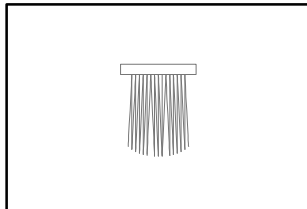

ΒΟΥΡΤΣΑΚΙ No 12

weather brush No 12

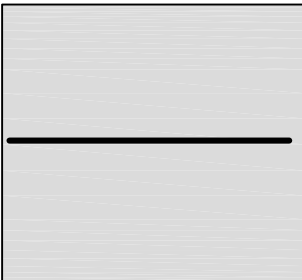
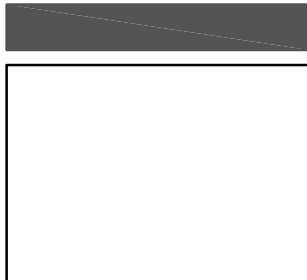

ΛΑΣΤΙΚΟ “ΦΟΥΣΚΑΚΙ”

bubble seal

LA 201



ΛΑΣΤΙΚΟ ΜΟΝΩΣΗΣ
(ΚΑΣΑ ΜΕ ΑΡΜΟΚΑΛΥΠΤΡΟ)

Outer frame sealing gasket

LA 303

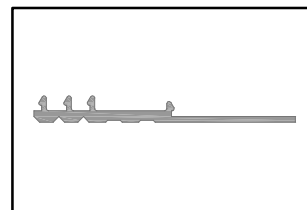

ΛΑΣΤΙΚΟ ΚΕΝΤΡΙΚΟ
ΣΤΕΓΑΝΩΣΗΣ

central gasket

LA 300

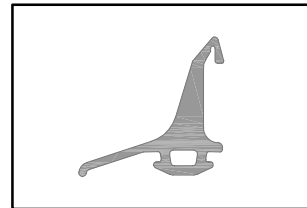

ΛΑΣΤΙΧΟΓΩΝΙΑ

vulcanized rubber

LA 304

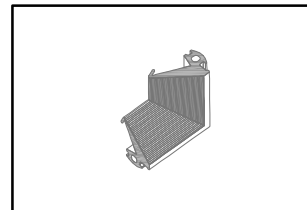

ΒΟΥΡΤΣΑΚΙ No 14

weather brush No 14

VR 814

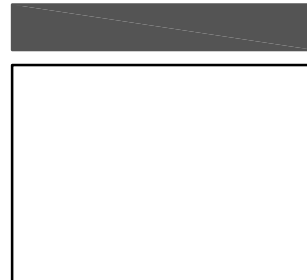
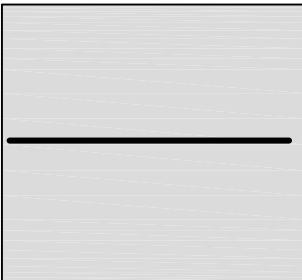
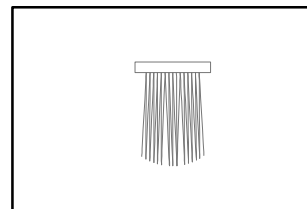

ΠΡΕΣΑΚΙ ΓΙΑ: SLIM-200, 8000, ENERGY 22

punching press for: SLIM-200, 8000, ENERGY 22

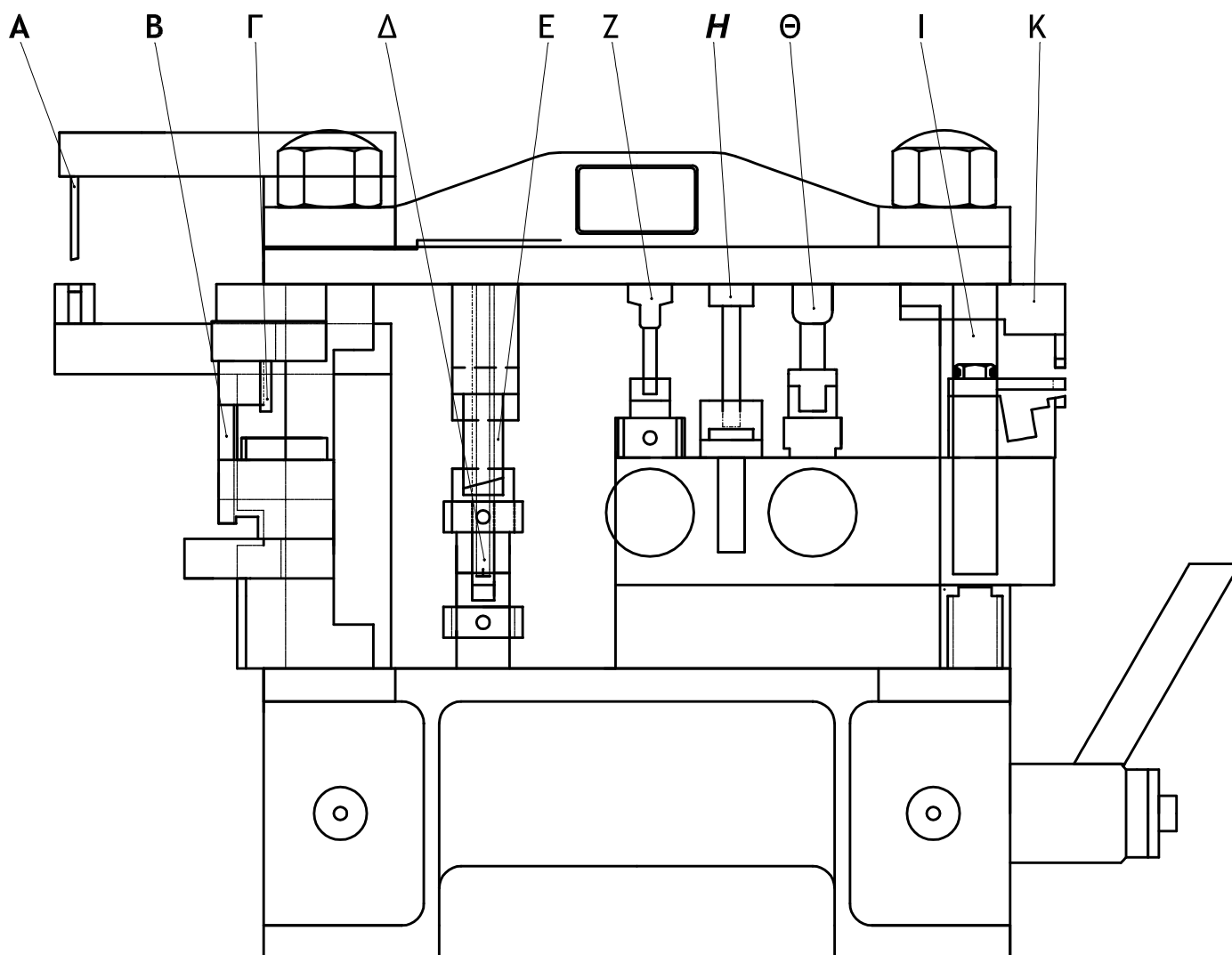

Α/Α	ΕΙΔΟΣ ΚΑΤΕΡΓΑΣΙΑΣ	TYPE OF CUTTING
Α	ΟΠΗ ΚΑΒΙΛΙΑΣ ΜΙΚΡΟΥ ΘΑΛΑΜΟΥ ΓΙΑ ΘΕΡΜΟ	perforator for cotter pin corner bracket GN 301
Β	ΚΟΠΤΙΚΟ ΣΠΑΝΙΟΛΕΤΑΣ	perforator for espagnolette
Γ	ΚΟΠΤΙΚΟ ΤΑΨ (ΑΝΘΡΩΠΑΚΙ) AC 830	perforator for connecting bracket AC 830
Δ	ΤΡΥΠΗΤΙΚΟ ΓΩΝΙΑΣ ΣΥΝΔΕΣΗΣ	perforator for corner cleats
Ε	ΤΡΥΠΗΤΙΚΟ ΓΩΝΙΑΣ ΣΥΝΔΕΣΗΣ 219 (GN 212)	perforator for corner cleats GN 212
Ζ	ΤΡΥΠΗΤΙΚΟ ΤΑΜΠΛΑ Ø6	perforator for bottom rail Ø6
Η	ΤΡΥΠΗΤΙΚΟ ΝΤΙΖΑΣ	perforator for connecting rod
Θ	ΤΡΥΠΗΤΙΚΟ ΤΑΜΠΛΑ Ø11	perforator for bottom rail Ø11
Ι	ΚΟΠΤΙΚΟ ΓΙΑ ΝΥΧΑΚΙ	cutting off edges of sashes's connecting rod tunnel
Κ	ΚΟΠΤΙΚΟ ΝΕΡΟΧΥΤΗ	perforator for drainage