

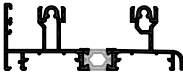

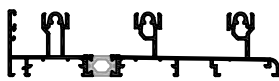

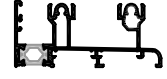

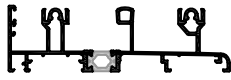

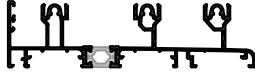
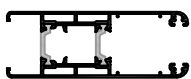
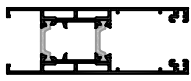
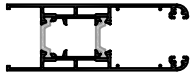

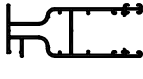

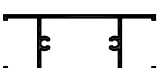
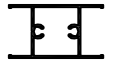

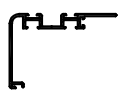
ΚΩΔΙΚΟΣ code	ΣΧΗΜΑ shape	ΒΑΡΟΣ gr/m weight gr/m	ΜΗΚΟΣ length	ΠΕΡΙΓΡΑΦΗ description	ΣΕΛΙΔΑ page
16168		818	6m	ΜΟΝΟΣ ΟΔΗΓΟΣ Single rail	6
16160		1360	6m	ΔΙΠΛΟΣ ΟΔΗΓΟΣ Double rail overlapping	6
16162		1856	6m	ΤΡΙΠΛΟΣ ΟΔΗΓΟΣ Triple rail overlapping	6
16169		1234	6m	ΔΙΠΛΟΣ ΟΔΗΓΟΣ (Τζάμι-σήτα) Double rail (Sash & insect screen)	7
16166		1612	6m	ΤΡΙΠΛΟΣ ΟΔΗΓΟΣ (Τζάμι-σήτα-πατζούρι) Triple rail (Sash-insect screen-shutter)	7
16164		1819	6m	ΤΡΙΠΛΟΣ ΟΔΗΓΟΣ (Επάλληλο με σήτα) Triple rail (Double sash overlapping with insect screen)	7
16250		1551	6m	ΦΥΛΛΟ ΠΟΜΠΕ Sash	8
16252		1580	6m	ΦΥΛΛΟ ΙΣΙΟ Sash	8
16254		1538	6m	ΦΥΛΛΟ ΠΟΜΠΕ Sash	8
7260		1164	6m	ΦΥΛΛΟ ΠΟΜΠΕ Sash	8
7261		1194	6m	ΦΥΛΛΟ ΙΣΙΟ Sash	8
7270		766	6m	ΦΥΛΛΟ ΣΗΤΑΣ mosquito screen frame	8

**ΣΥΝΟΠΤΙΚΟ**  
**summary**

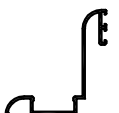
ΚΩΔΙΚΟΣ code	ΣΧΗΜΑ shape	ΒΑΡΟΣ weight gr/m	ΜΗΚΟΣ length	ΠΕΡΙΓΡΑΦΗ description	ΣΕΛΙΔΑ page
16360		1431	6m	ΔΙΑΧΩΡΙΣΤΙΚΗ ΤΡΑΒΕΡΣΑ transom	9
7371		857	6m	ΔΙΑΧΩΡΙΣΤΙΚΗ ΤΡΑΒΕΡΣΑ transom	9
7373		581	6m	ΔΙΑΧΩΡΙΣΤΙΚΗ ΤΡΑΒΕΡΣΑ transom	9
7375		709	6m	ΔΙΑΧΩΡΙΣΤΙΚΗ ΤΡΑΒΕΡΣΑ ΣΗΤΑΣ transom for mosquito screen frame	9
16630		477	6m	ΓΑΝΤΖΟΣ hook	10
16632		755	6m	ΜΠΙΝΙ ΑΝΤΙΚΡΥΣΤΩΝ ΦΥΛΛΩΝ adaptor for opposite sashes	9
7634		465	4,60m 5m	ΜΠΙΝΙ ΑΝΤΙΚΡΥΣΤΩΝ ΦΥΛΛΩΝ adaptor for opposite sashes	9
7636		213	4,60m 5m	ΜΠΙΝΙ ΑΝΤΙΚΡΥΣΤΩΝ ΦΥΛΛΩΝ ΣΗΤΑΣ adaptor for opposite sashes	9
7532		508	4,60m 5m	ΑΡΜΟΚΑΛΥΠΤΡΟ closure for pocket doors or windows	10
7534		501	4,60m 5m	ΑΡΜΟΚΑΛΥΠΤΡΟ closure for pocket doors or windows	10
7752		153	4,60m 5m	ΚΑΠΑΚΙ ΑΡΜΟΚΑΛΥΠΤΡΟΥ 4512 cup for closure 4512	10
7754		137	4,60m 5m	ΚΑΠΑΚΙ ΑΡΜΟΚΑΛΥΠΤΡΟΥ 4550 cup for closure 4550	10

**ΣΥΝΟΠΤΙΚΟ**  
**summary**

ΚΩΔΙΚΟΣ code	ΣΧΗΜΑ shape	ΒΑΡΟΣ weight gr/m	ΜΗΚΟΣ length	ΠΕΡΙΓΡΑΦΗ description	ΣΕΛΙΔΑ page
7756		236	6m	ΠΡΟΣΘΗΚΗ ΣΗΤΑΣ ΓΙΑ ΒΟΥΡΤΣΑΚΙ adaptor for mosquito screen frame	10
16530		224	6m	ΚΟΡΝΙΖΑ ΚΟΥΜΠΩΤΗ wall closure	10
8506		285	6m	ΚΟΡΝΙΖΑ wall closure	10
7750		82	6m	ΛΑΜΑΚΙ ΑΛΟΥΜΙΝΙΟΥ aluminium cup	6

ΠΡΟΦΙΛ 1:1  
profiles 1:1

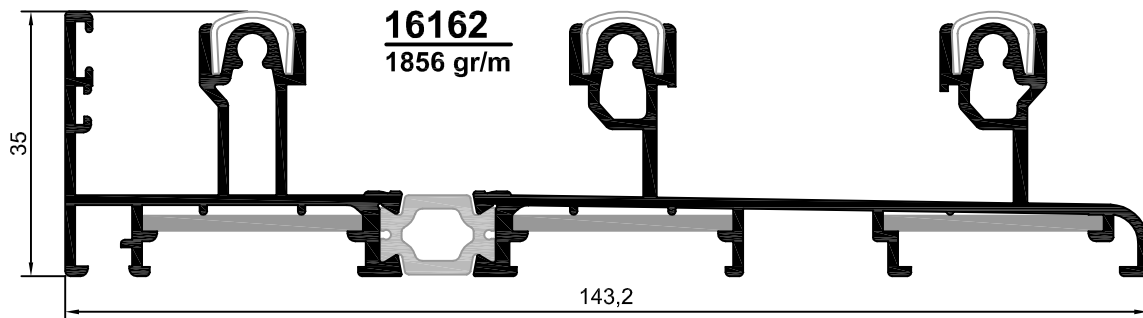
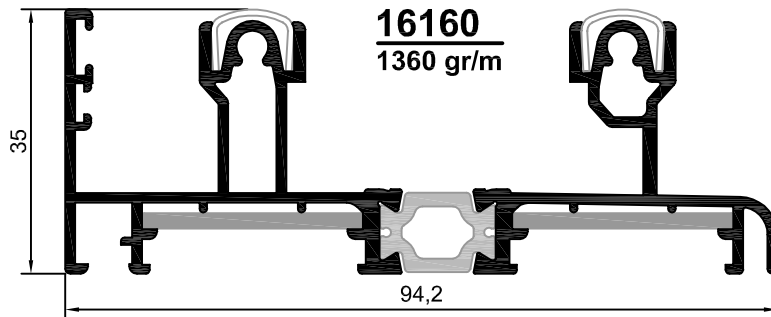
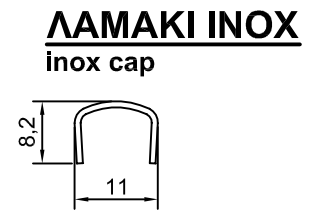
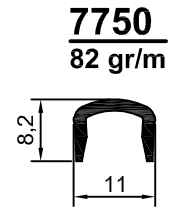
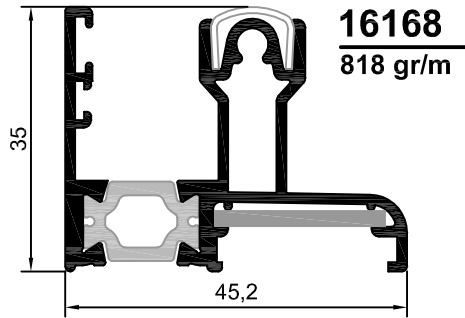

ΠΡΟΦΙΛ 1:1  
profiles 1:1

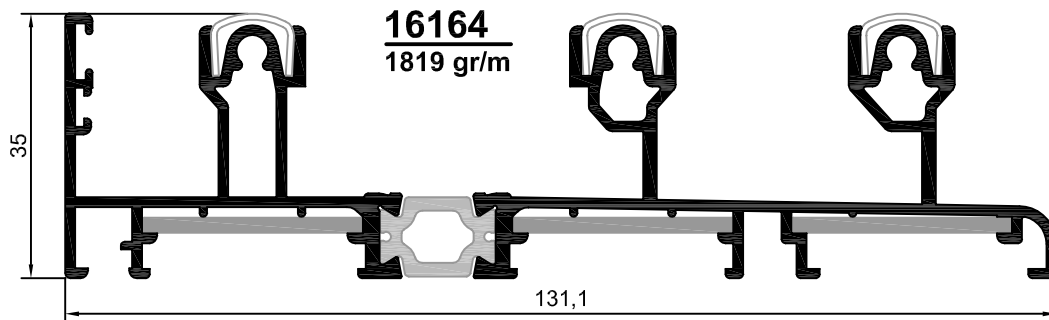
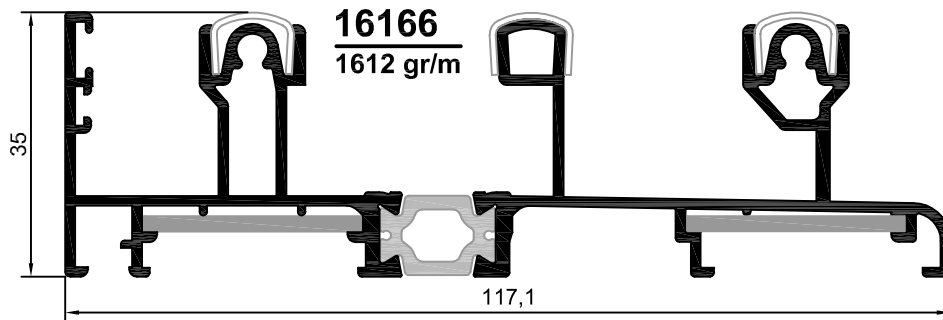
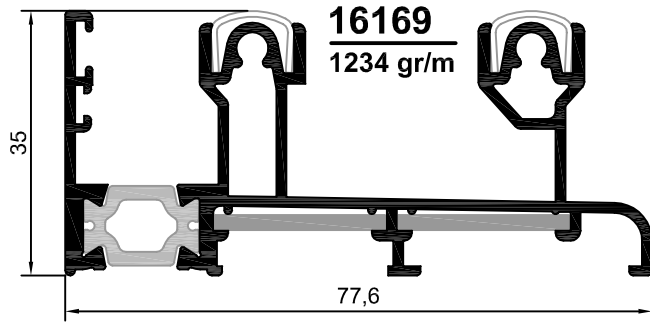

ΠΡΟΦΙΛ 1:1  
profiles 1:1

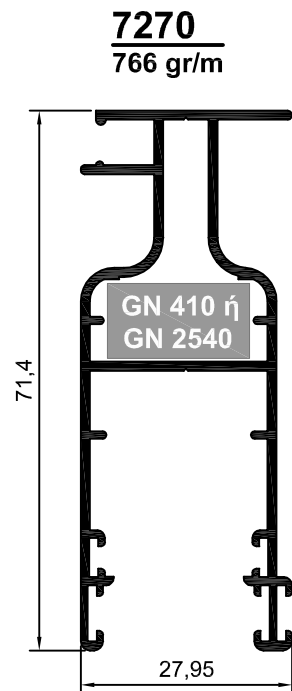
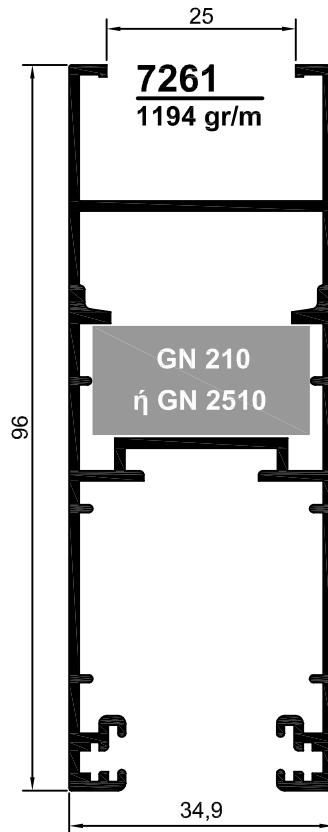
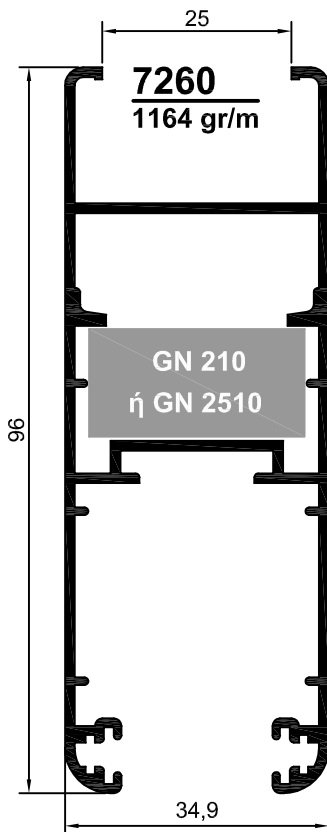
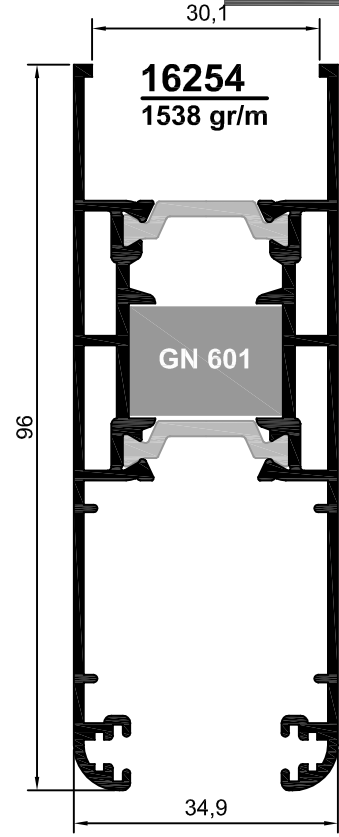
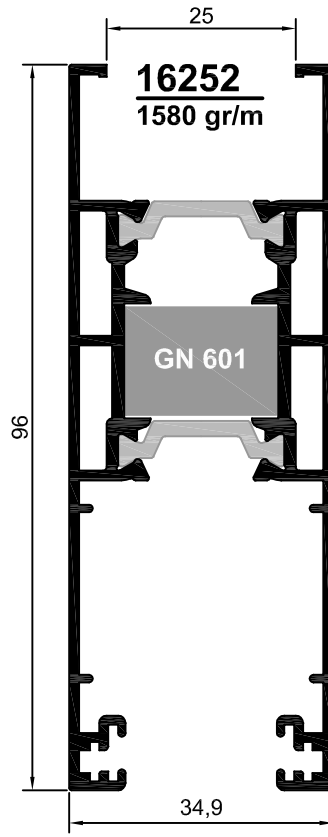
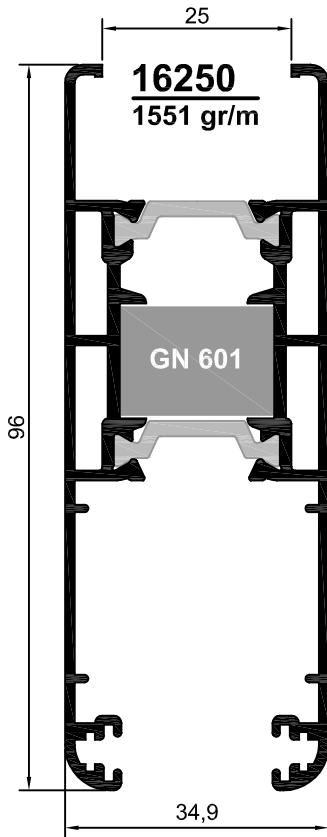

ΠΡΟΦΙΛ 1:1  
profiles 1:1

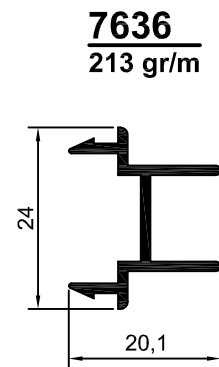
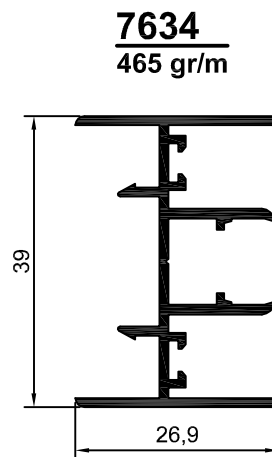
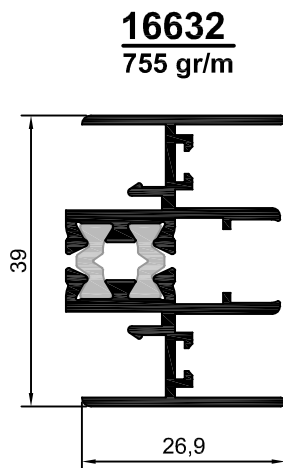
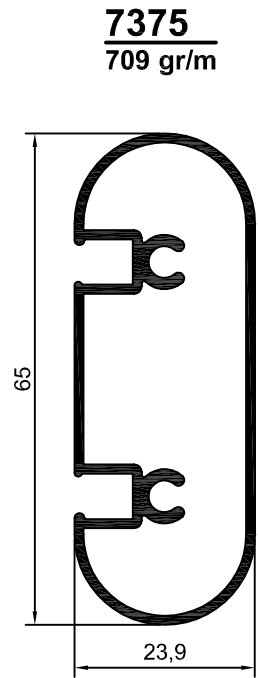
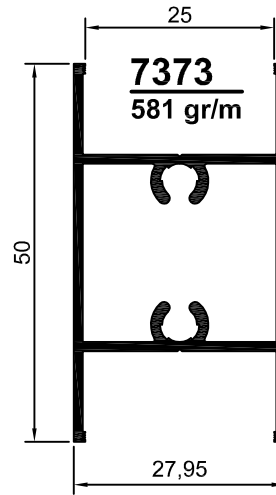
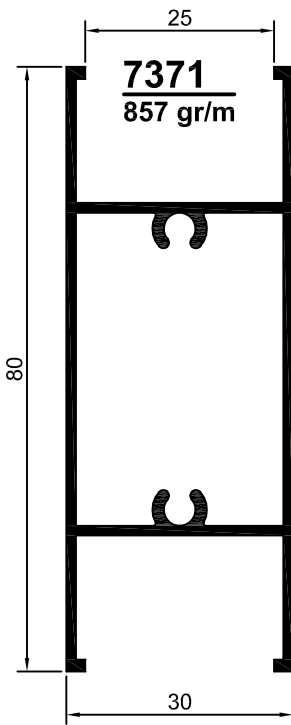
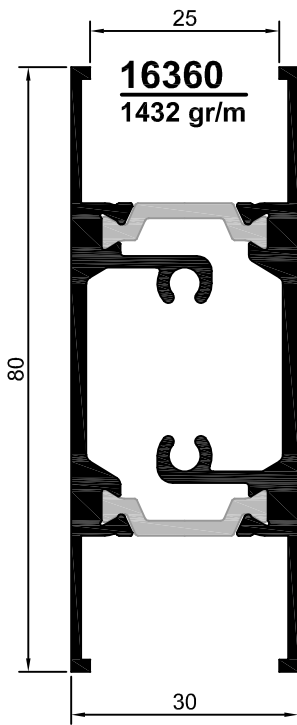

ΠΡΟΦΙΛ 1:1  
profiles 1:1

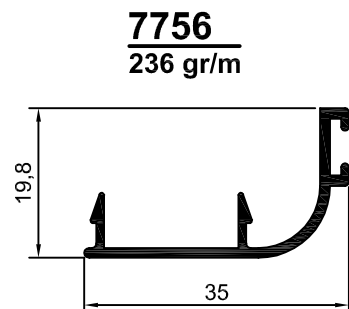
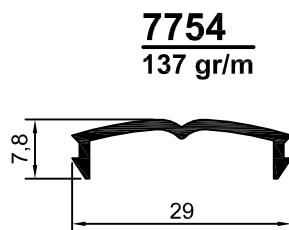
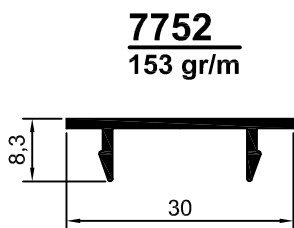
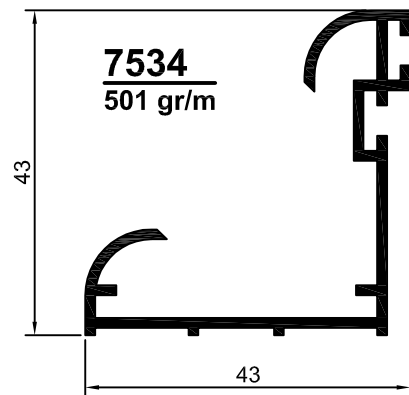
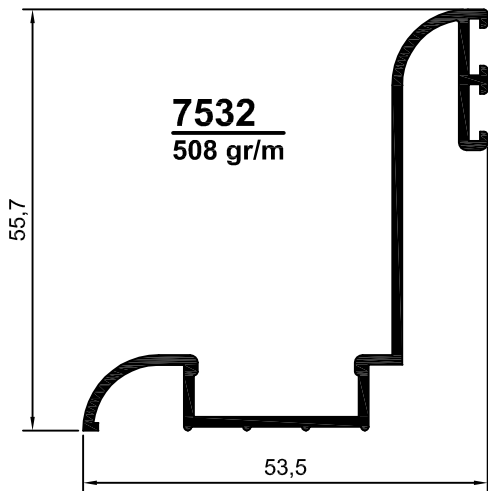
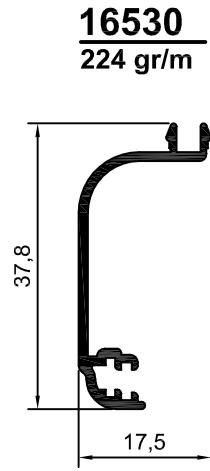
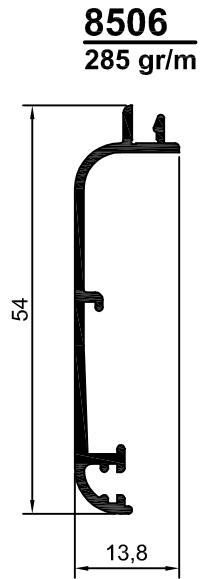
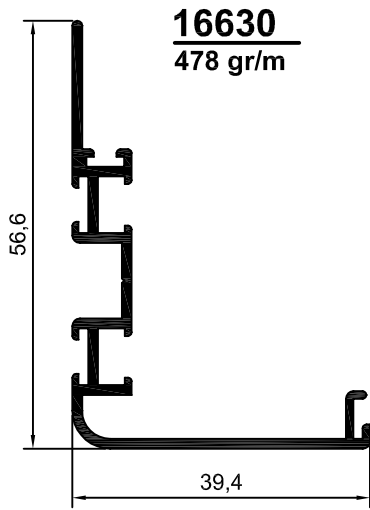



ΠΡΟΦΙΛ 1:1  
profiles 1:1

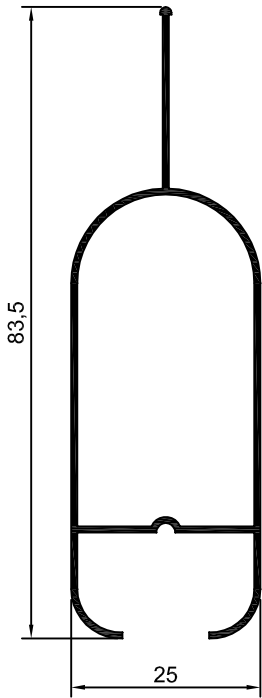

**25520**  
406 gr/m

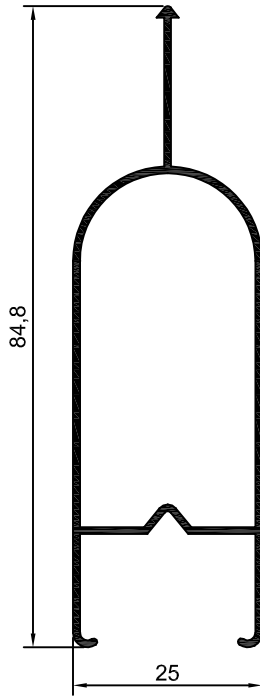

**25523**  
467 gr/m

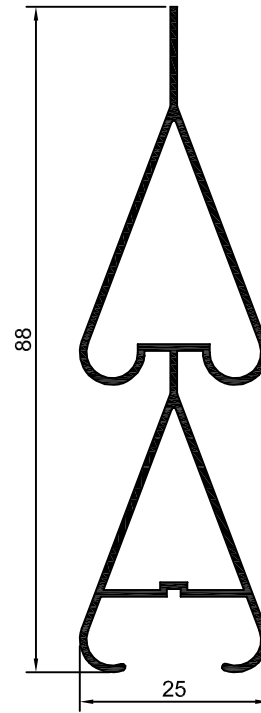

**25521**  
553 gr/m

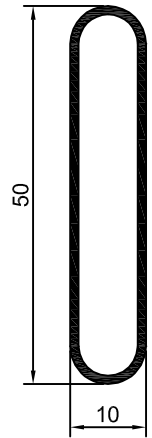

**10x50**  
322 gr/m

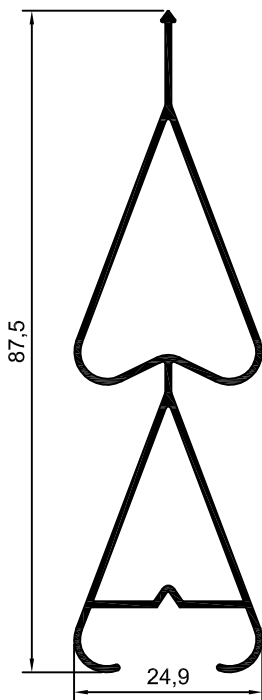

**25521A**  
483 gr/m

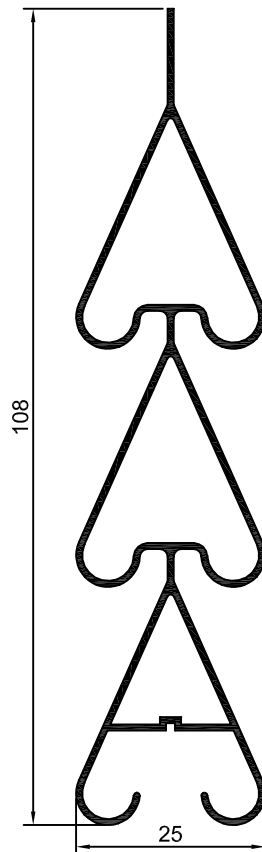

**25529**  
682 gr/m

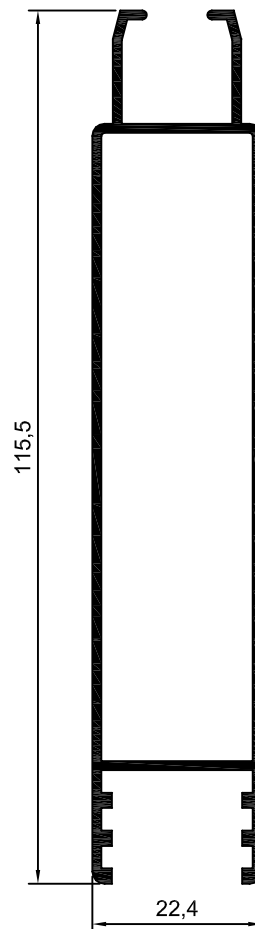

**25351**  
933 gr/m

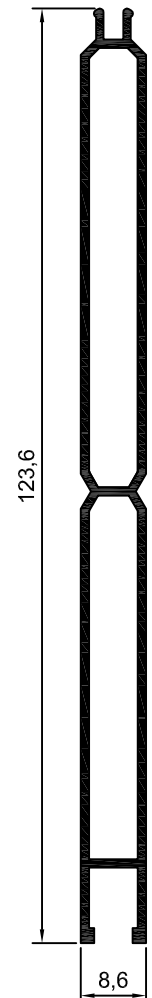

**9700**  
790 gr/m

**TOMEΣ 1:1**  
**sections 1:1**

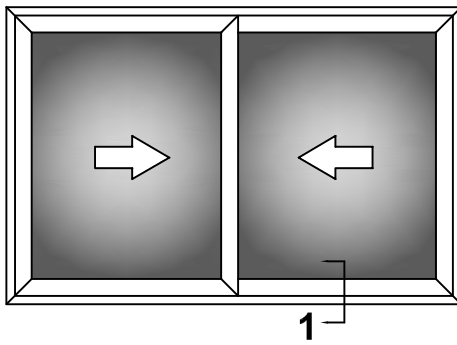

**ΔΙΦΥΛΛΟ ΕΠΑΛΛΗΛΟ**  
**double sash overlapping**

**TOMH 1**  
**section 1**

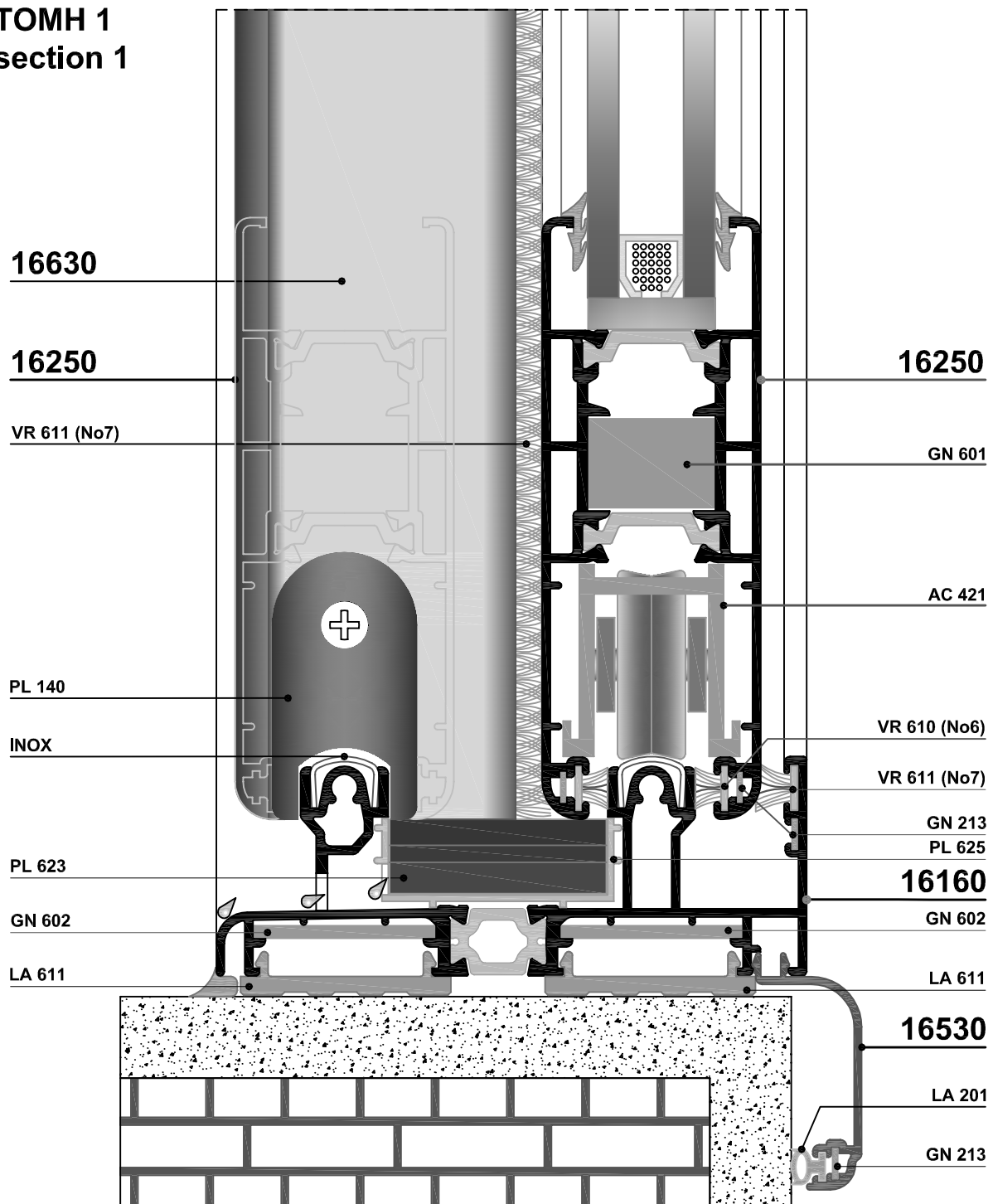

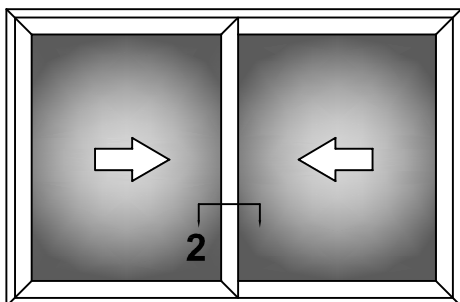

**TOMEΣ 1:1**  
**sections 1:1**

**ΔΙΦΥΛΛΟ ΕΠΑΛΛΗΛΟ**  
**double sash overlapping**

**TOMH 2**  
**section 2**

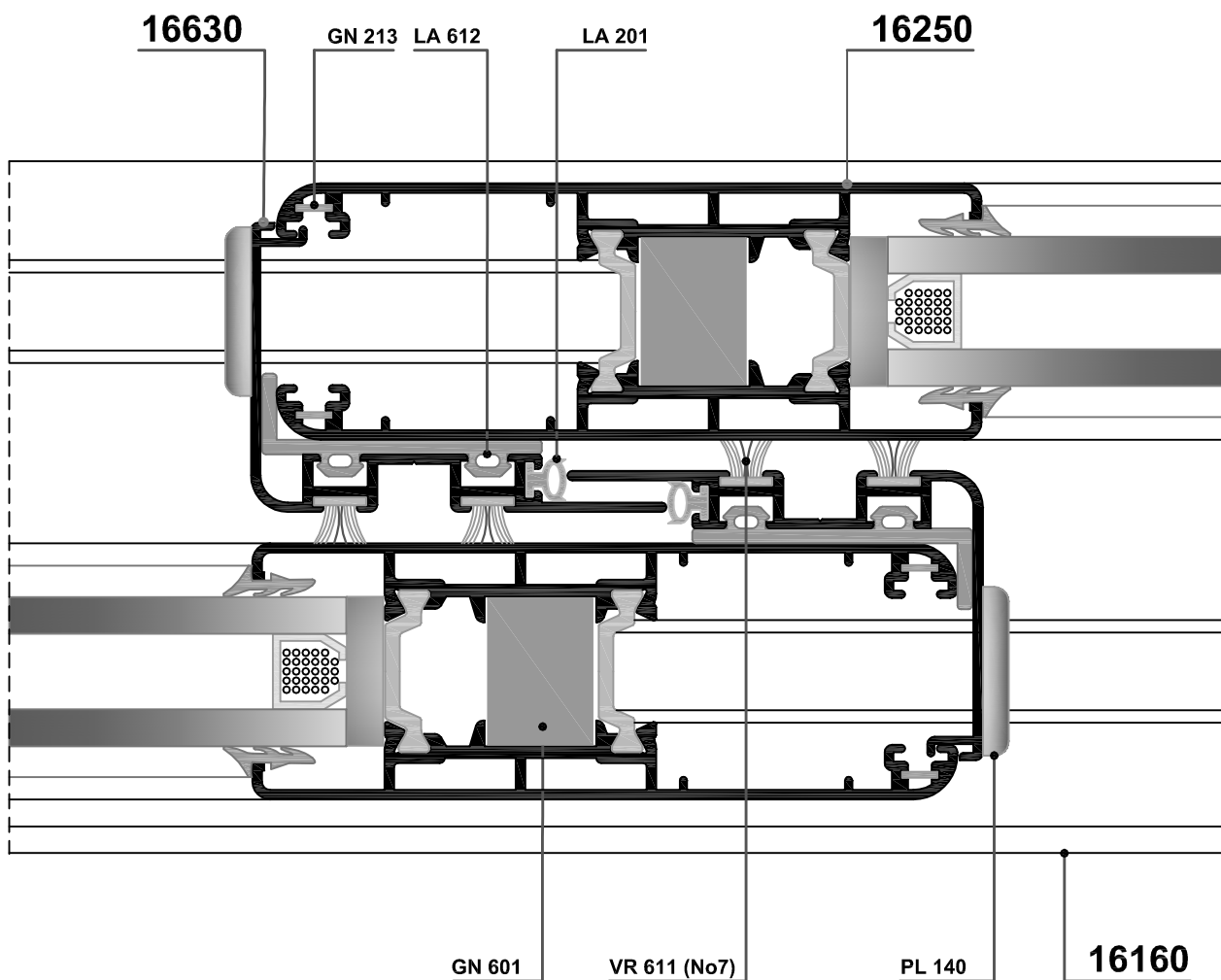

**TOMEΣ 1:1**  
**sections 1:1**

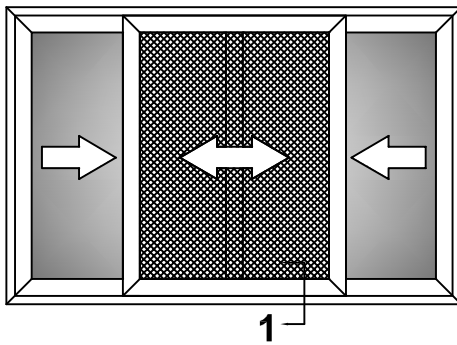

**ΔΙΦΥΛΛΟ ΕΠΑΛΛΗΛΟ ΜΕ ΣΗΤΑ**  
**double sash overlapping**  
**with insect screen**

**TOMH 1**  
**section 1**

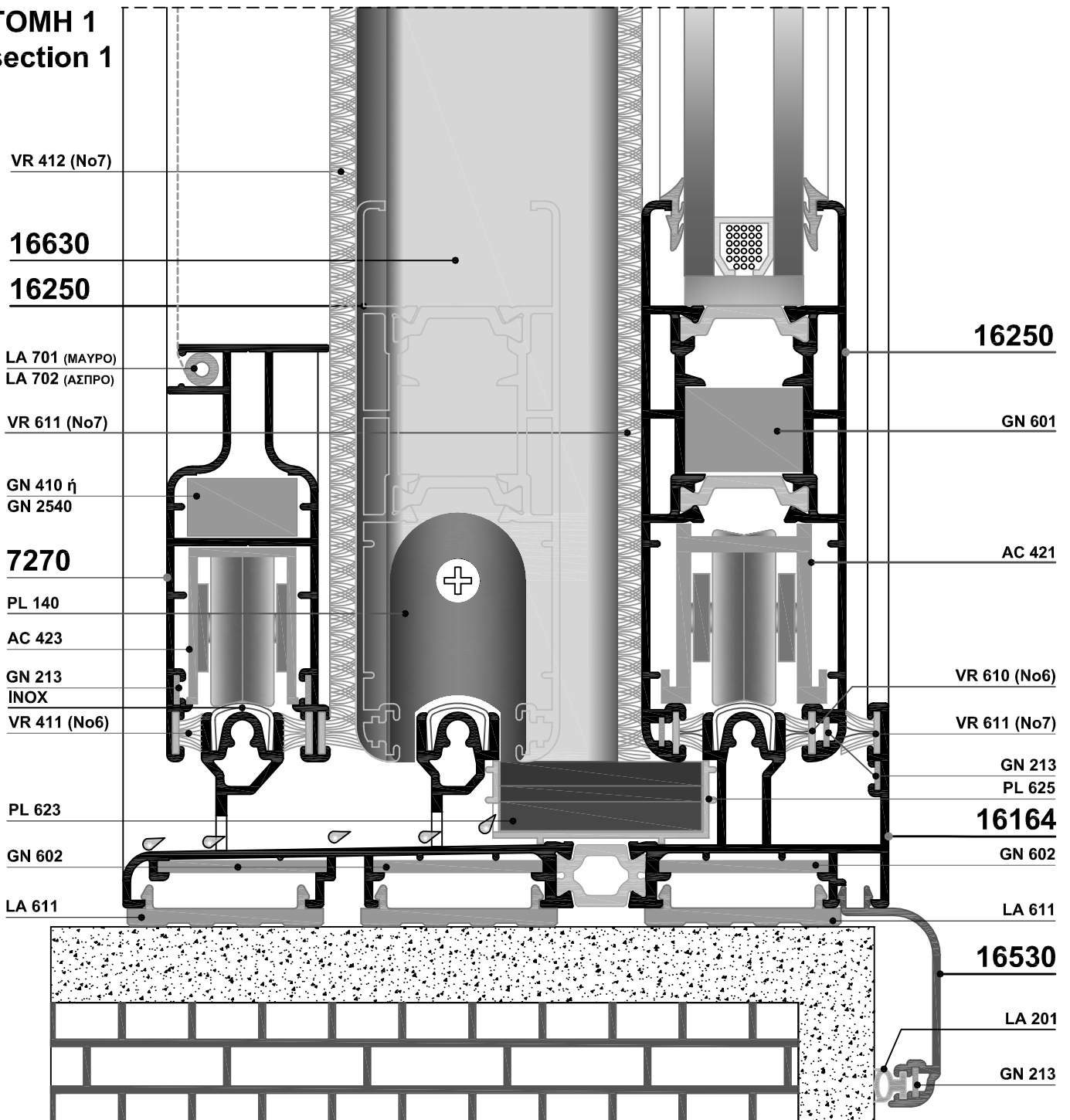

**TOMEΣ 1:1**  
**sections 1:1**

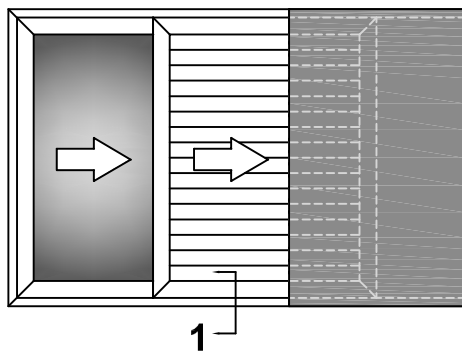

**ΤΖΑΜΙ - ΠΑΤΖΟΥΡΙ ΧΩΝΕΥΤΑ**  
**glass - shutter in the wall**

**TOMH 1**  
**section 1**

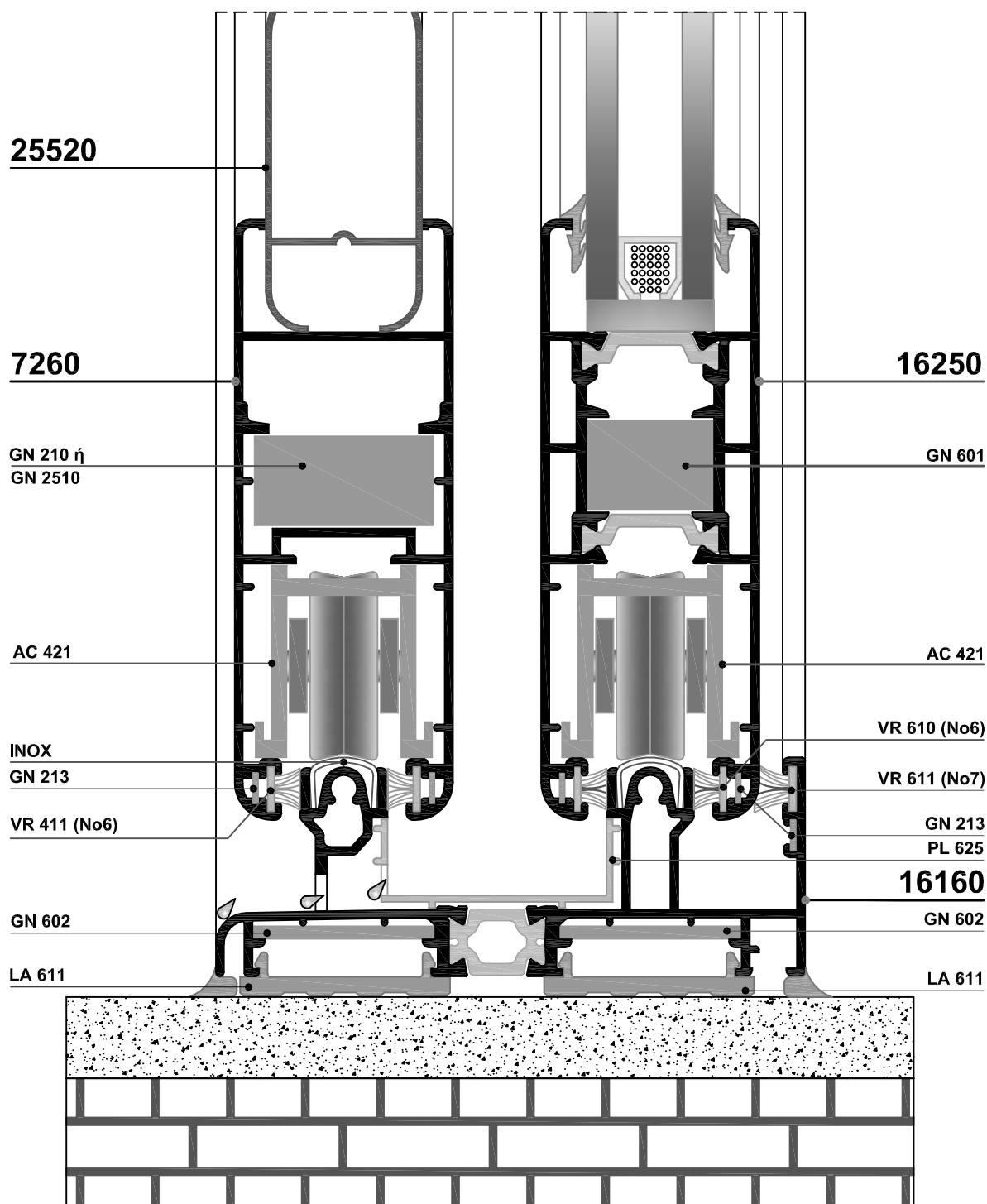

**TOMEΣ 1:1**  
**sections 1:1**

**ΤΖΑΜΙ - ΣΗΤΑ - ΠΑΤΖΟΥΡΙ ΧΩΝΕΥΤΑ**  
**glass - insect screen - shutter in the wall**

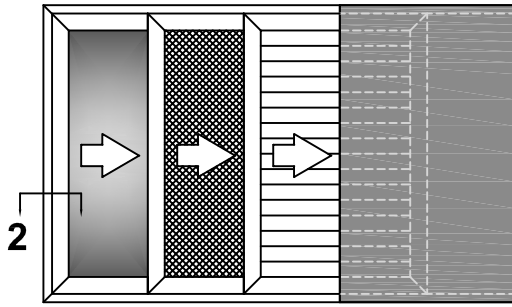

**TOMH 2**  
**section 2**

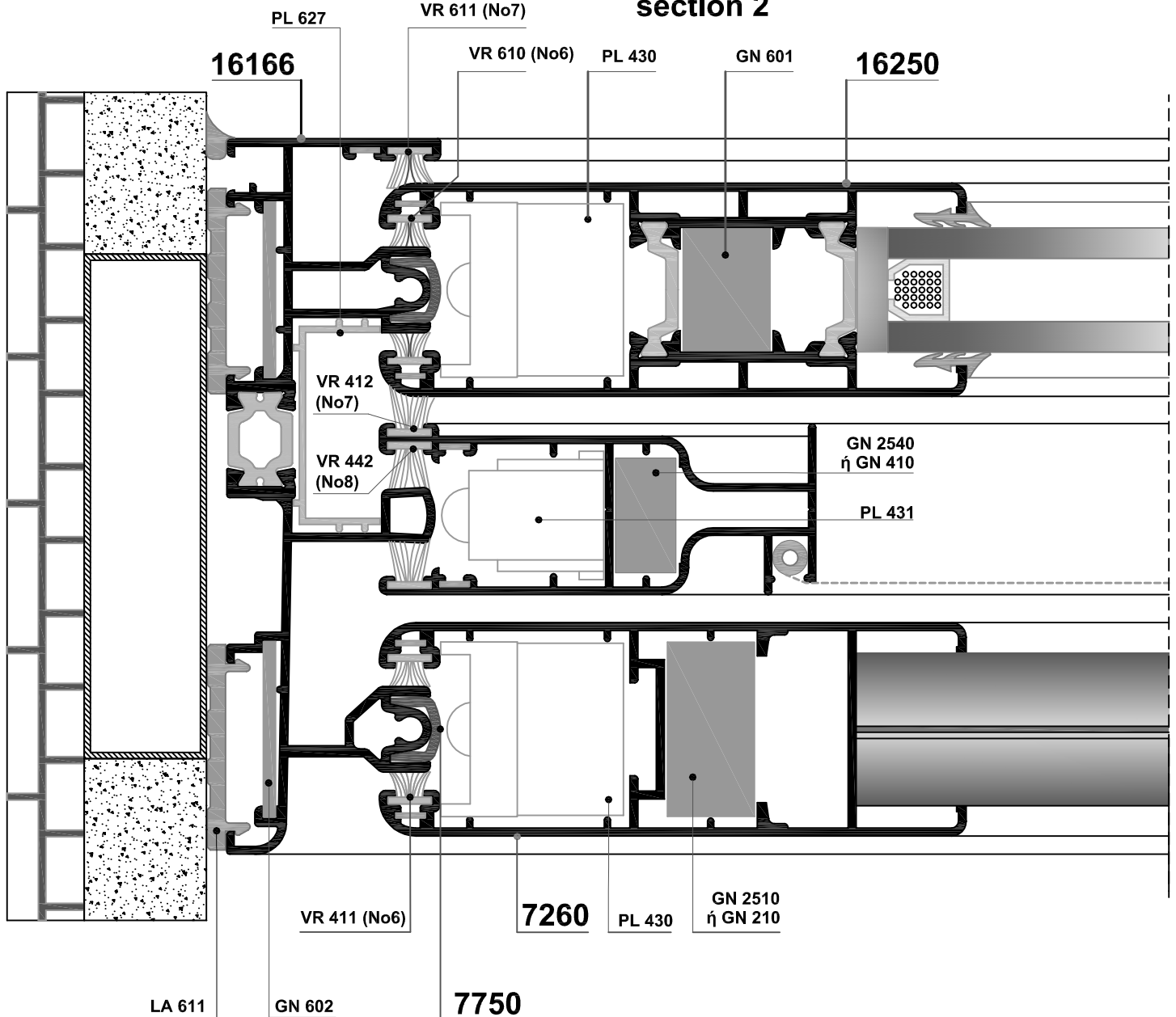



METALOUMIN

# ENERGY 16



METALOUMIN

TOMEΣ 1:1  
sections 1:1

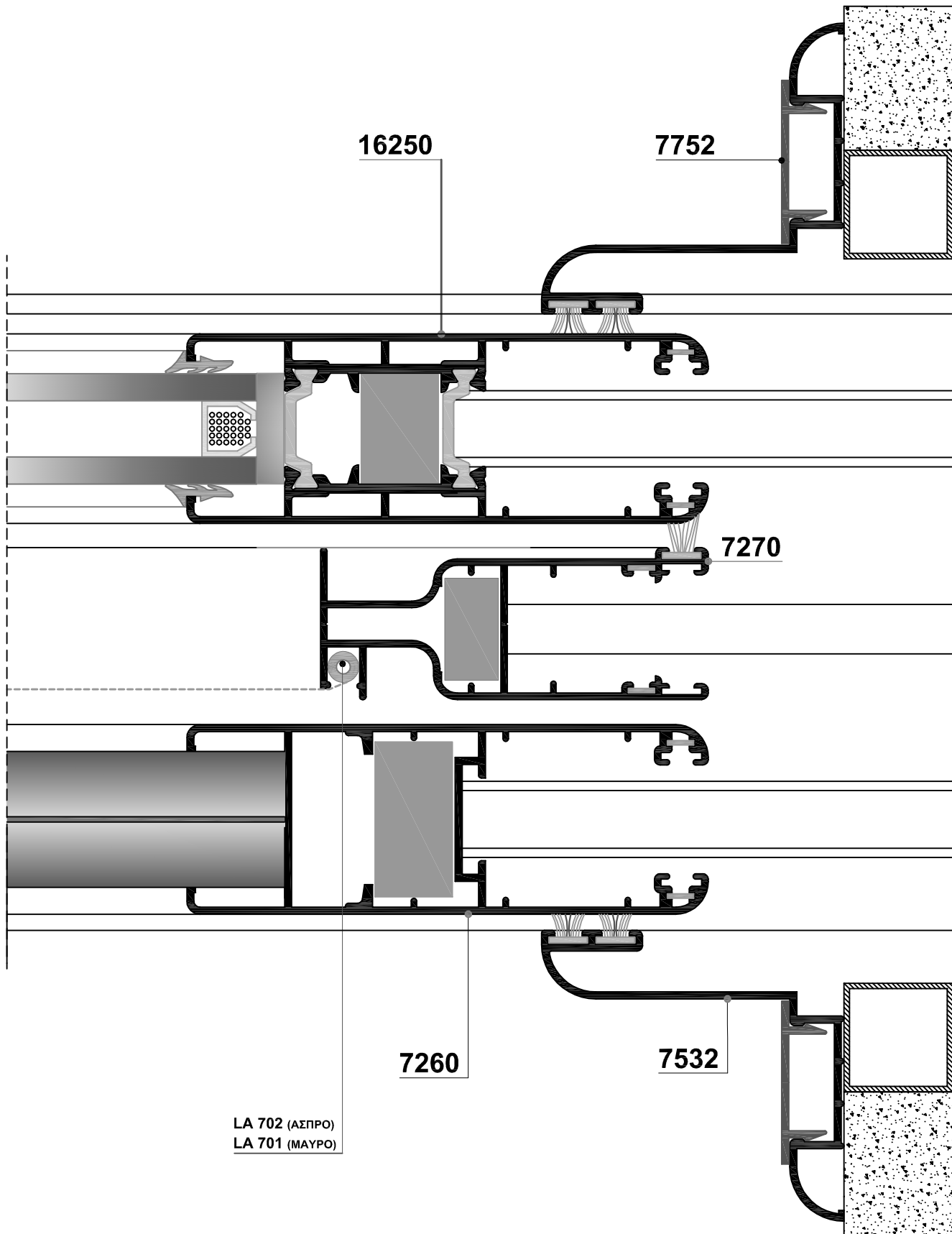

**TOMEΣ 1:1**  
**sections 1:1**

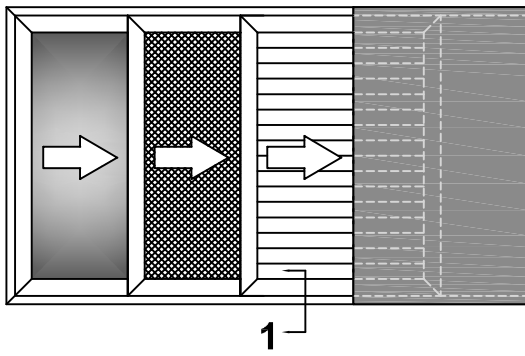

**ΤΖΑΜΙ - ΣΗΤΑ - ΠΑΤΖΟΥΡΙ ΧΩΝΕΥΤΑ**  
**glass - insect screen - shutter in the wall**

**TOMH 1**  
**section 1**

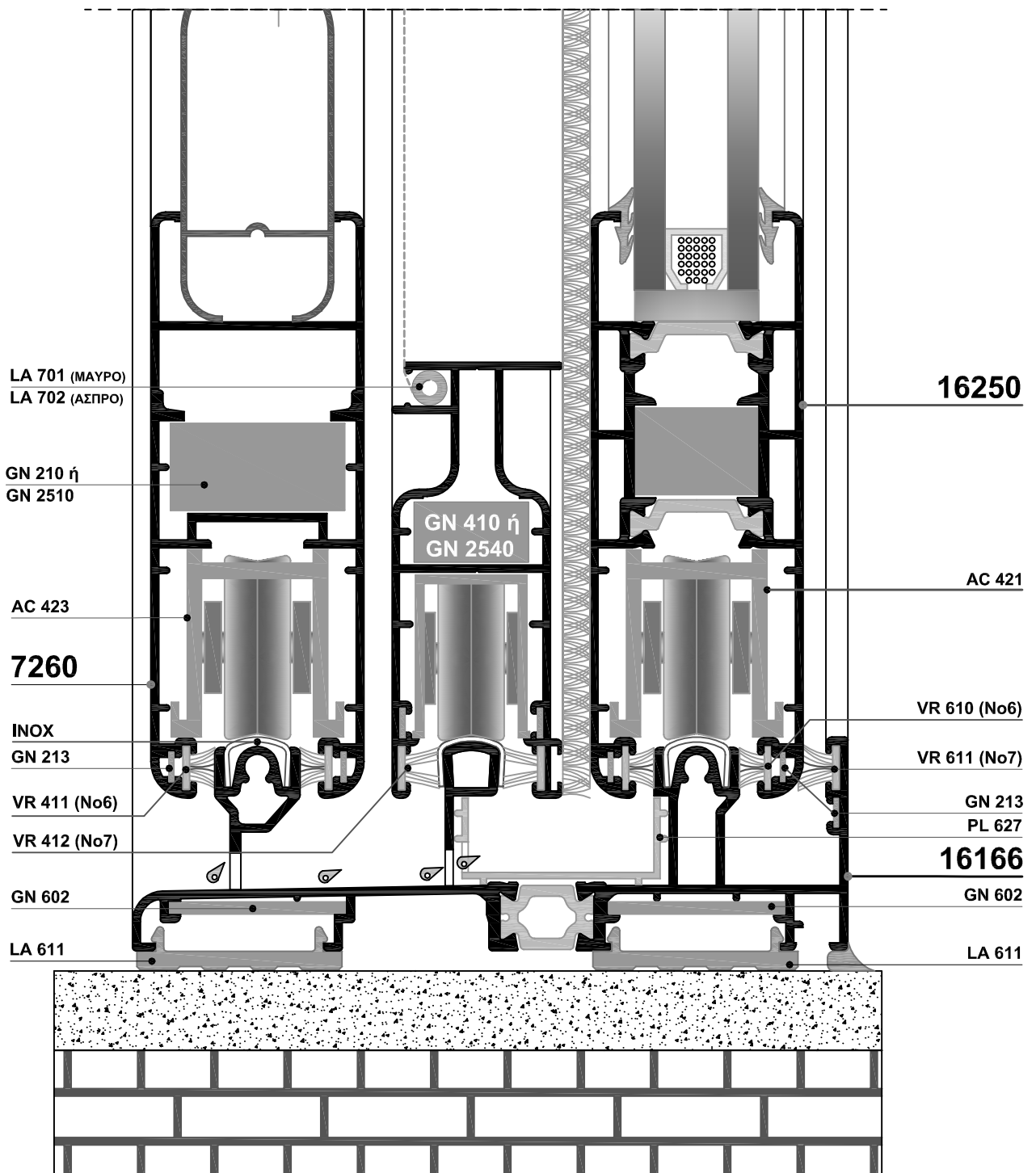



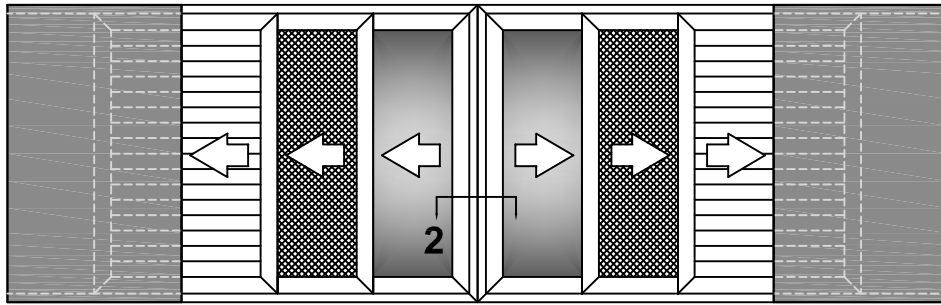

TOMEΣ 1:1  
sections 1:1

TOMH 2  
section 2

**ΤΖΑΜΙ - ΣΗΤΑ - ΠΑΤΖΟΥΡΙ ΑΝΤΙΚΡΤΣΤΑ ΧΩΝΕΥΤΑ**  
opposite glass - insect screen - shutters in the wall

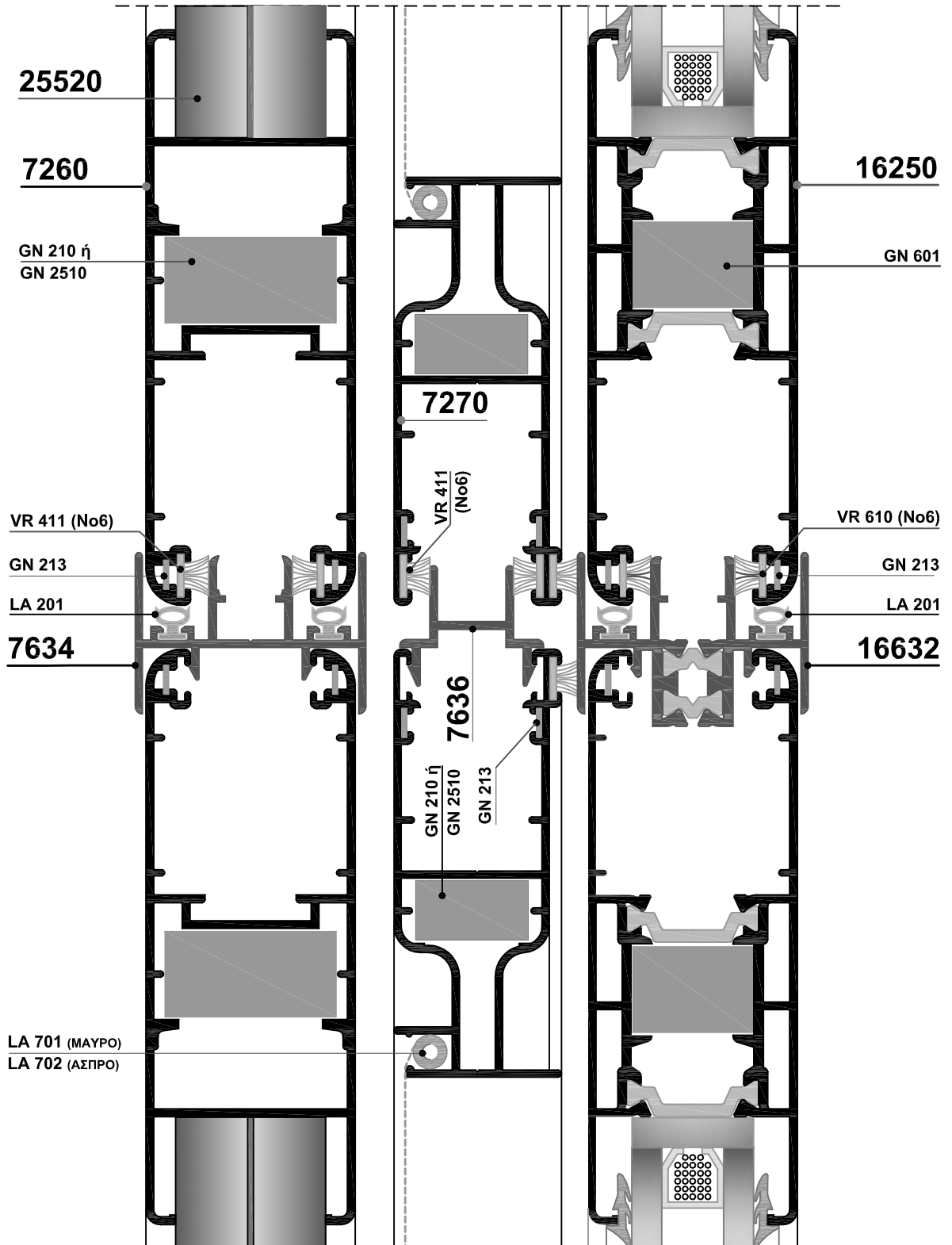

**TOMEΣ 1:1**  
**sections 1:1**

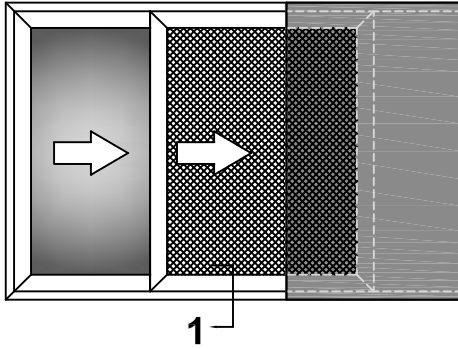

**TZAMI - ΣΗΤΑ ΧΩΝΕΥΤΑ**  
**glass - insect screen in the wall**

**TOMH 1**  
**section 1**

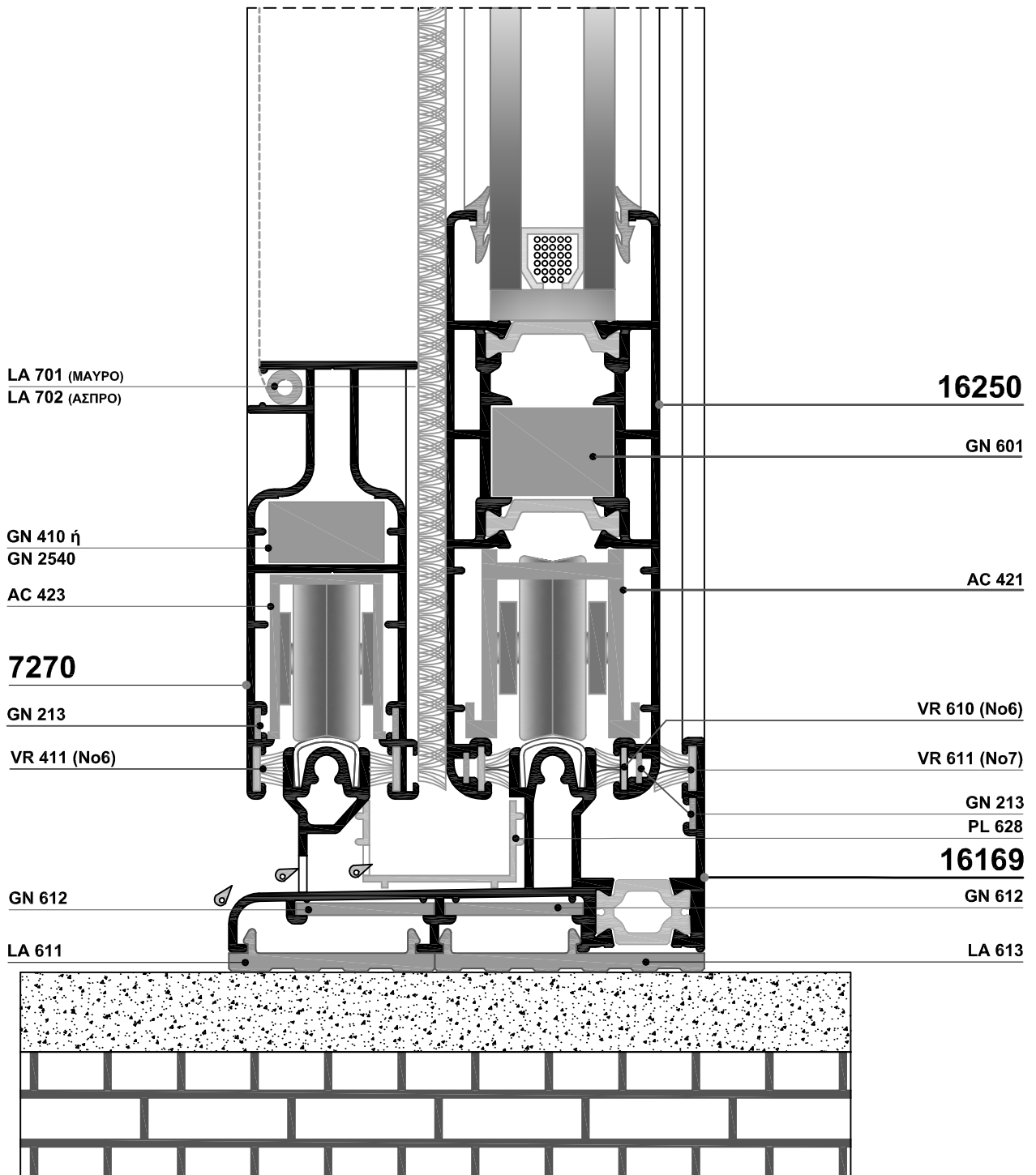

**TOMEΣ 1:1**  
**sections 1:1**

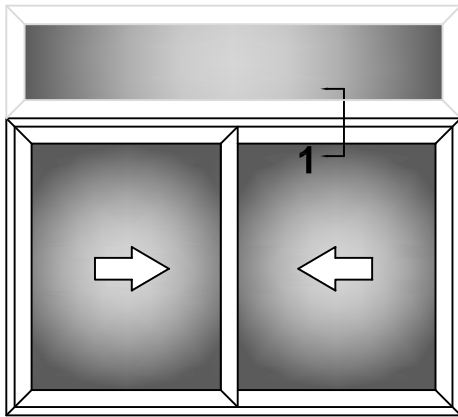

**ΔΙΦΥΛΛΟ ΕΠΑΛΛΗΛΟ ΜΕ ΦΕΓΓΙΤΗ**

**double sash overlapping with dormer window**

**TOMH 1**  
**section 1**

**22149**

**GN 602**

**PL 625**

**PL 623**

**7750**

**PL 140**

**VR 611 (No7)**

**16250**

**16630**

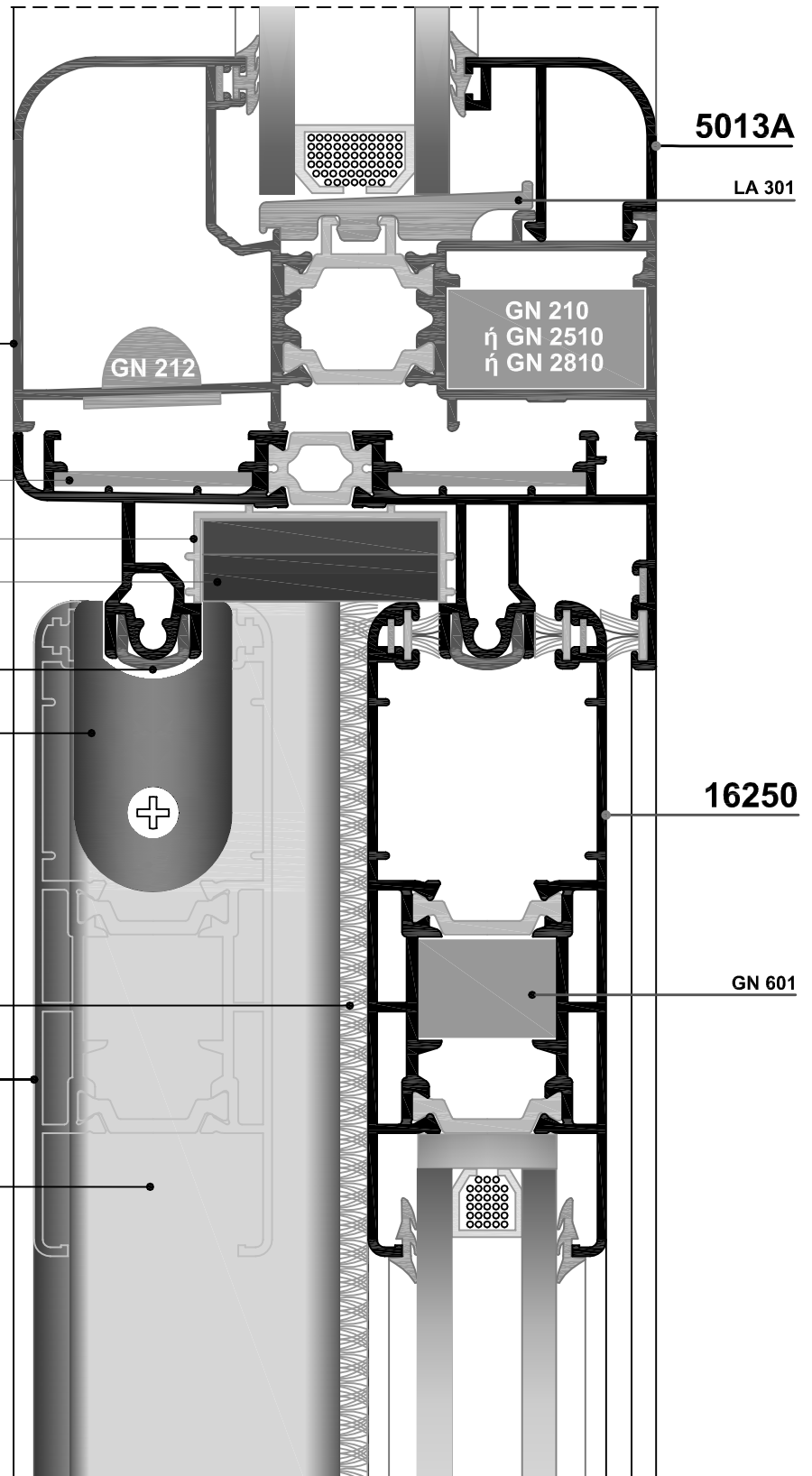

**5013A**

**LA 301**

**GN 210**  
**ή GN 2510**  
**ή GN 2810**

**GN 212**

**16250**

**GN 601**



ΕΠΕΙΞΕΡΓΑΣΙΕΣ  
machining

### ΣΥΝΑΡΜΟΛΟΓΗΣΗ ΟΔΗΓΩΝ

ΚΟΨΤΕ ΤΟΥΣ ΟΔΗΓΟΥΣ ΜΕ ΕΝΣΩΜΑΤΩΜΕΝΕΣ ΤΙΣ ΜΟΝΩΤΙΚΕΣ ΠΡΟΣΘΗΚΕΣ PL 625, ΚΑΙ ΚΑΤΟΠΙΝ ΑΦΑΙΡΕΣΤΕ ΤΙΣ, ΚΑΙ ΑΝΟΙΞΤΕ ΝΕΡΟΧΥΤΕΣ ΣΤΟΥΣ ΟΔΗΓΟΥΣ, ΚΑΙ ΣΤΙΣ ΜΟΝΩΤΙΚΕΣ ΠΡΟΣΘΗΚΕΣ.

### RAILS ASSEMBLING

Cut the rails with the insulating profiles PL 625 in place, then remove the insulating profiles and proceed with punching the holes for water drainage.

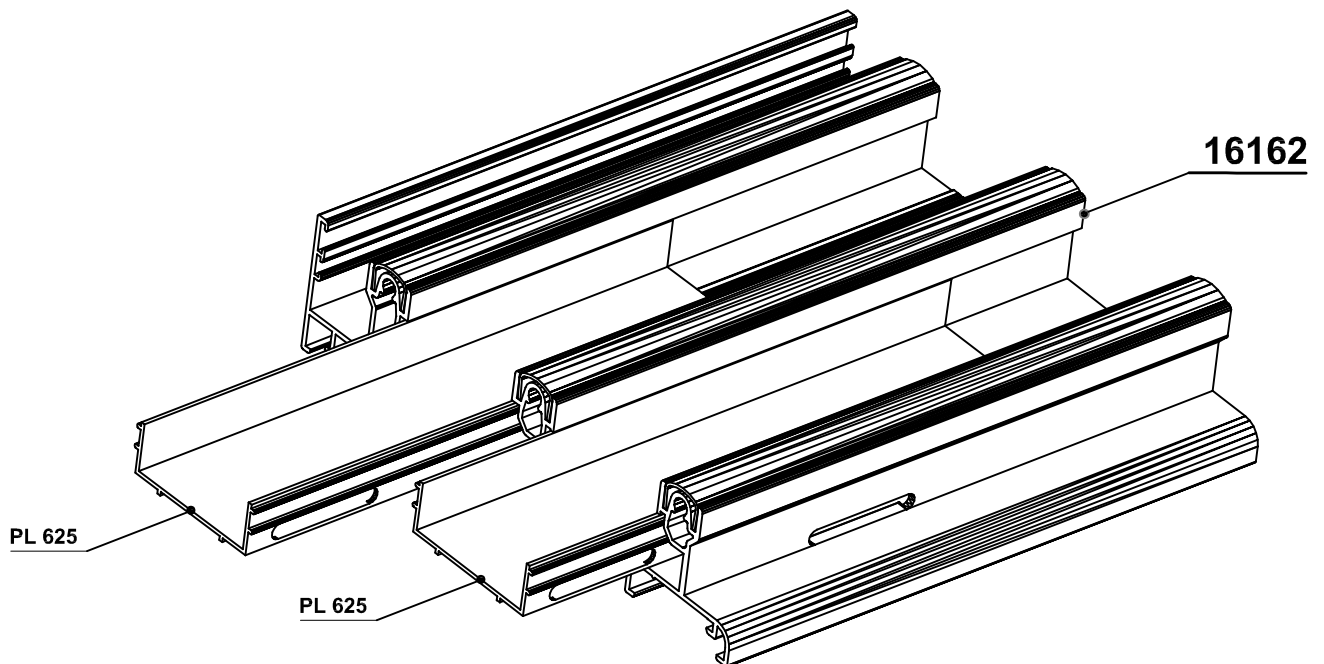
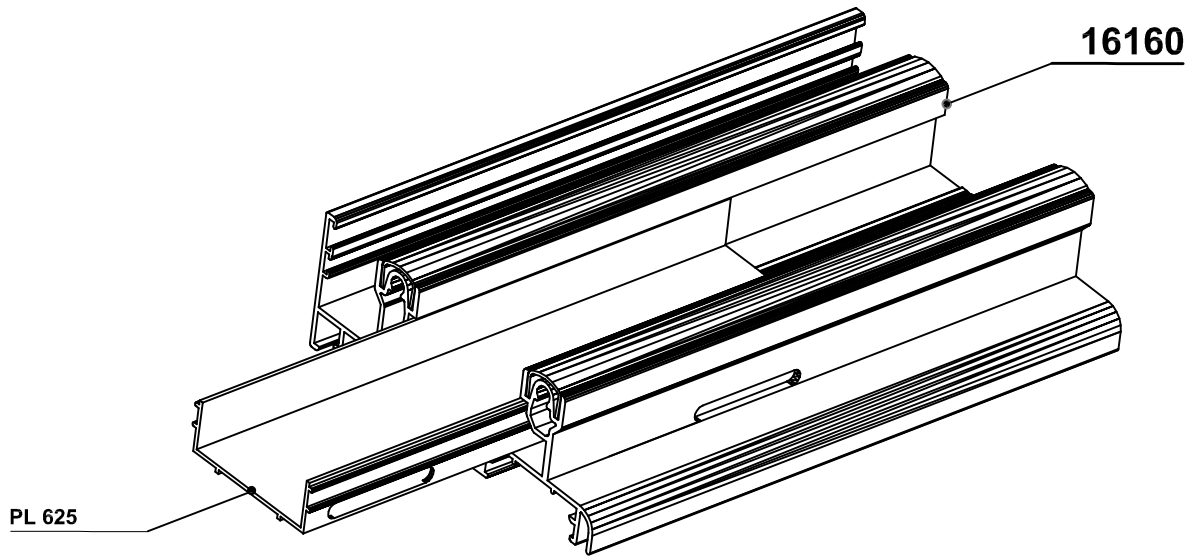

## ΤΟΠΟΘΕΤΗΣΗ ΓΑΝΤΖΟΥ ΕΠΑΛΛΗΛΟΥ

- 1) ΚΟΨΤΕ ΤΟΥΣ ΓΑΝΤΖΟΥΣ ΣΤΟ ΙΔΙΟ ΥΨΟΣ ΜΕ ΤΑ ΦΥΛΛΑ
- 2) ΤΟΠΟΘΕΤΗΣΤΕ ΤΟ ΜΟΝΩΤΙΚΟ ΛΑΣΤΙΚΟ LA 612
- 3) ΑΓΚΥΡΩΣΤΕ ΤΟΝ ΓΑΝΤΖΟ ΣΤΗΝ ΠΛΕΥΡΑ (A)
- 4) ΒΙΔΩΣΤΕ ΜΕ ΛΑΜΑΡΙΝΟΒΙΔΕΣ ΣΤΟ ΣΗΜΕΙΟ (B)

## HOOK ASSEMBLING

- 1) Cut the hook at the size of sash's height
- 2) Place the insulating gasket LA 612
- 3) Fit the hook profile initially in point (A)
- 4) Screw the hook profile in point (B)

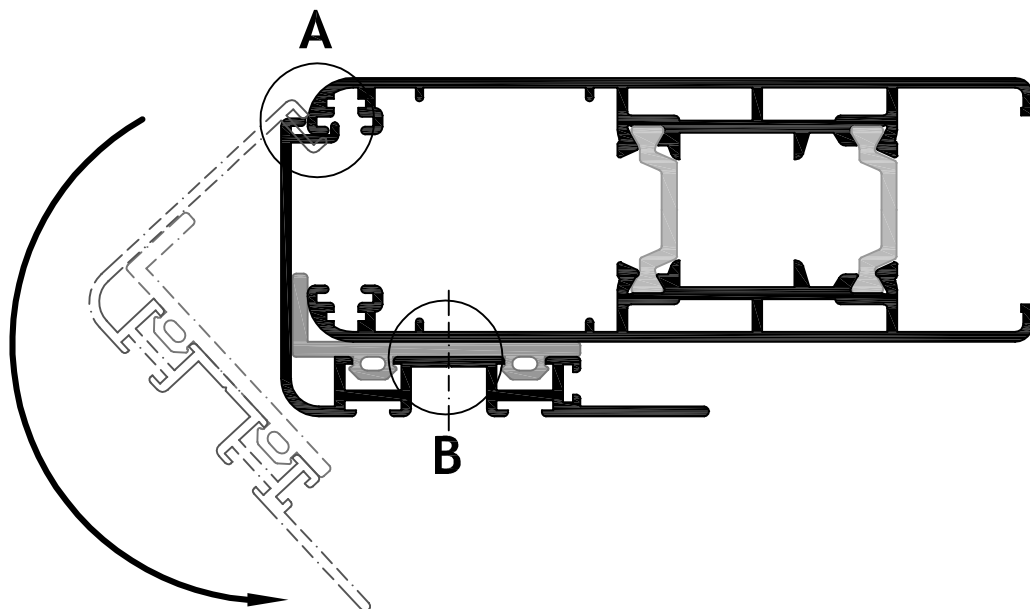

**ΣΥΝΔΕΣΗ ΟΔΗΓΩΝ ΜΕ ΤΙΣ ΓΩΝΙΕΣ GN 602**  
 rail assembly with corners GN 602

**ΕΠΕΙΞΕΡΓΑΣΙΕΣ**  
 machining

**ΧΡΗΣΙΜΟΠΟΙΗΣΤΕ ΜΟΝΟ**  
**ΦΡΕΖΑΤΕΣ ΒΙΔΕΣ!**  
 use conical headed screws

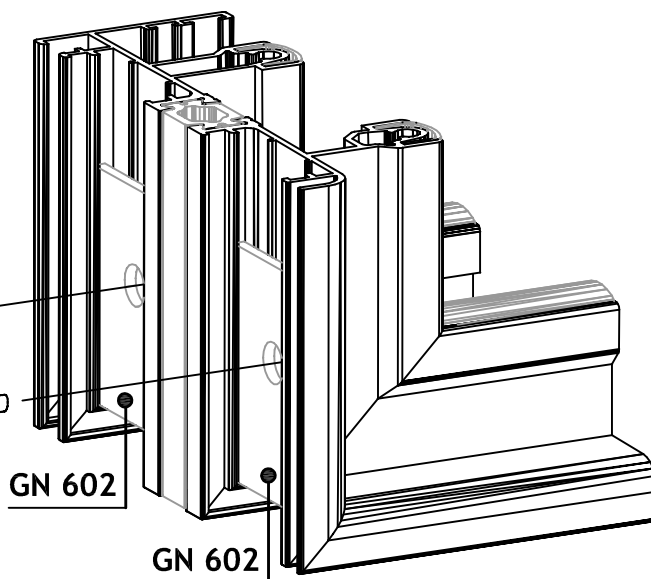

**ΠΡΕΣΑΚΙ ΣΥΡΟΜΕΝΩΝ / punching press for sliding**

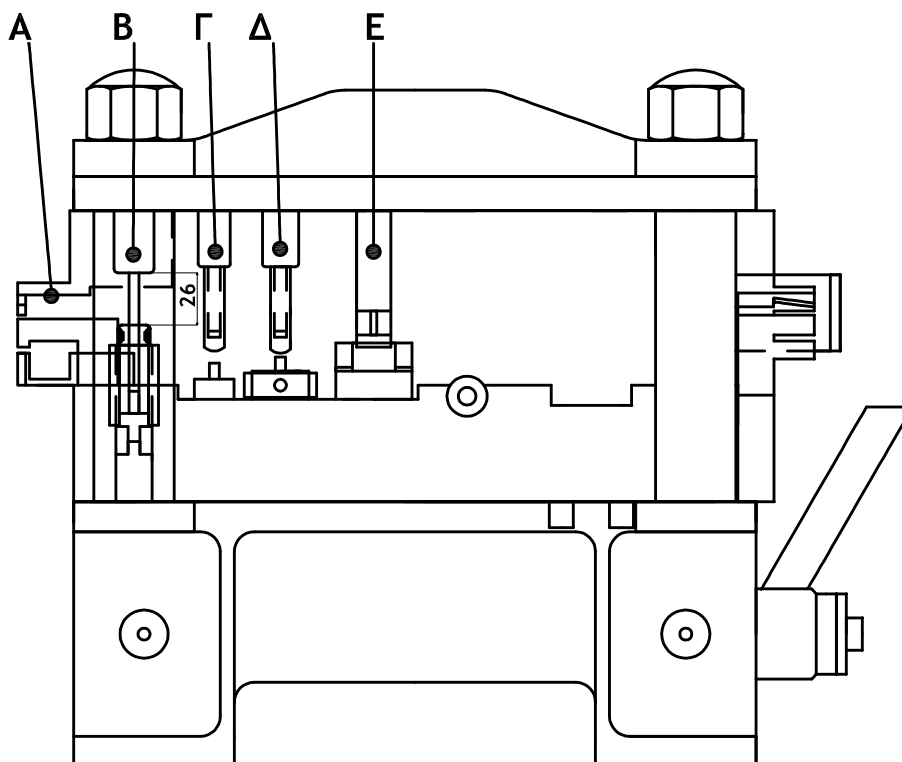

- A. ΤΡΥΠΗΤΙΚΟ ΝΕΡΟΧΥΤΗ ΚΑΤΩ ΟΔΗΓΟΥ / cutting tool for low rail drain hole
- B. ΤΡΥΠΗΤΙΚΟ ΓΙΑ ΓΩΝΙΑΣΜΑ ΟΔΗΓΩΝ / perforator of rail for aluminium corner GN 417
- Γ. ΤΡΥΠΗΤΙΚΟ ΓΩΝΙΑΣ ΣΥΝΔΕΣΗΣ ΣΗΤΑΣ / perforator for corner bracket of mosquito screen frame
- Δ. ΤΡΥΠΗΤΙΚΟ ΓΩΝΙΑΣ ΣΥΝΔΕΣΗΣ ΦΥΛΛΩΝ / perforator for corner bracket of sash profile
- E. ΤΡΥΠΗΤΙΚΟ ΤΑΠΑΣ ΓΑΝΤΖΟΥ / perforator of hook profile SLIM 140 for plastic plug

**ΚΟΠΕΣ**  
cutting  
instructions

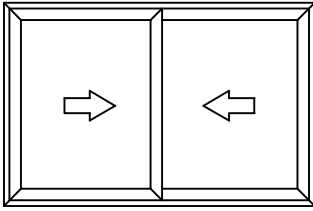

**ΔΙΦΥΛΛΟ ΕΠΑΛΛΗΛΟ**  
double sash overlapping

**ΟΔΗΓΟΣ (rail) 16160**

**ΦΥΛΛΟ (sashes) 16250, 16252, 16254**

ΠΚ = ΠΛΑΤΟΣ ΟΔΗΓΟΥ  
length of frame  
ΥΚ = ΥΨΟΣ ΟΔΗΓΟΥ  
height of frame  
ΠΦ = ΠΛΑΤΟΣ ΦΥΛΛΟΥ  
length of sash  
ΥΦ = ΥΨΟΣ ΦΥΛΛΟΥ  
height of sash

$$\text{ΠΦ} = (\text{ΠΚ} + 44) / 2$$

$$\text{ΥΦ} = \text{ΥΚ} - 51$$

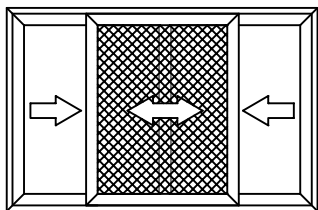
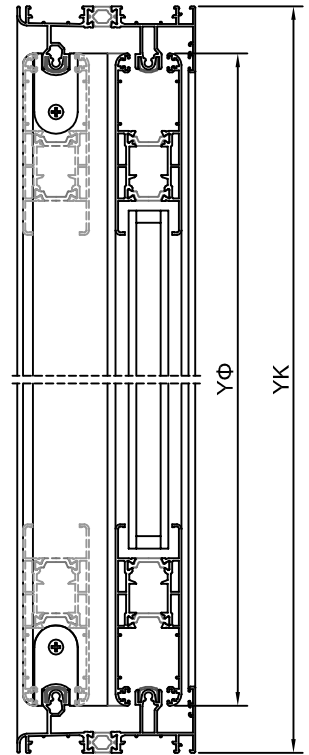
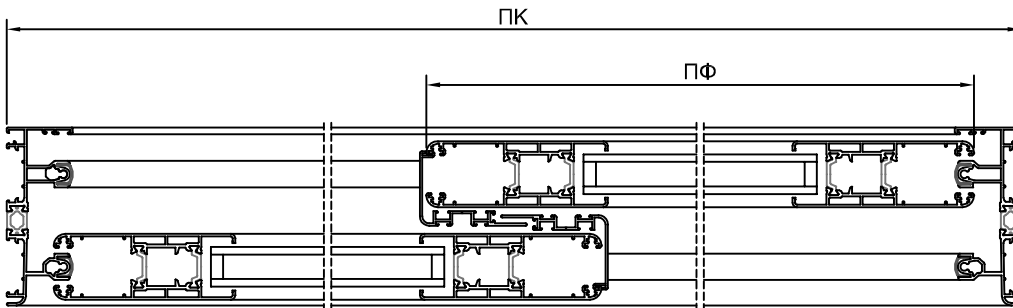

**ΔΙΦΥΛΛΟ ΕΠΑΛΛΗΛΟ ΜΕ ΣΗΤΑ**  
double sash overlapping  
with mosquito screen

**ΟΔΗΓΟΣ (rail) 16164**

**ΦΥΛΛΟ (sashes) 16250, 16252, 16254**

**ΣΗΤΑ (mosquito screen) 7270**

ΠΚ = ΠΛΑΤΟΣ ΟΔΗΓΟΥ  
length of frame  
ΥΚ = ΥΨΟΣ ΟΔΗΓΟΥ  
height of frame  
ΠΦ = ΠΛΑΤΟΣ ΦΥΛΛΟΥ  
length of sash  
ΥΦ = ΥΨΟΣ ΦΥΛΛΟΥ  
height of sash  
ΠΣ = ΠΛΑΤΟΣ ΣΗΤΑΣ  
height of sash

$$\text{ΠΦ} = (\text{ΠΚ} + 44) / 2$$

$$\text{ΥΦ} = \text{ΥΚ} - 51$$

$$\text{ΠΣ} = \text{ΠΚ} / 2$$

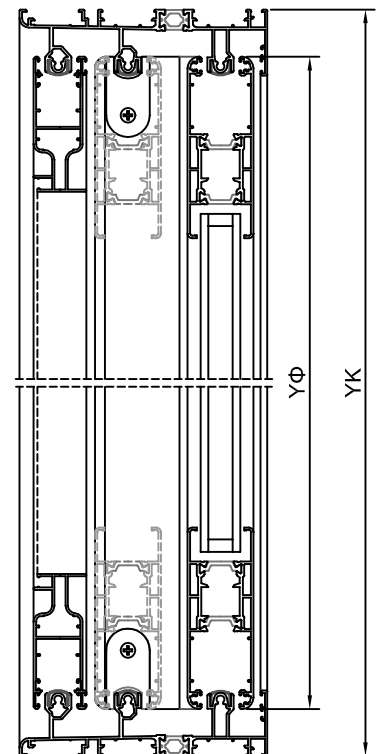
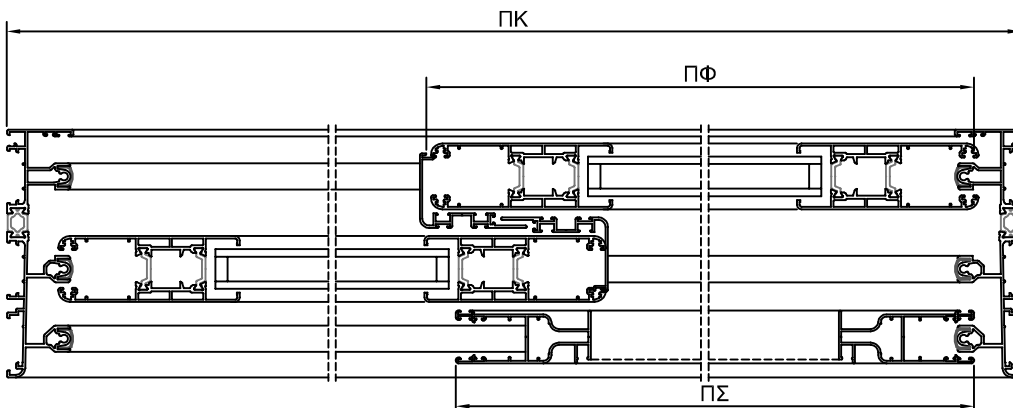

**ΚΟΠΕΣ**  
cutting  
instructions

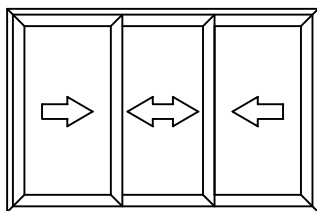

## ΤΡΙΦΥΛΛΟ ΕΠΑΛΛΗΛΟ

### triple sash overlapping

**ΟΔΗΓΟΣ (rail) 16162**

**ΦΥΛΛΟ (sashes) 16250, 16252, 16254**

ΠΚ = ΠΛΑΤΟΣ ΟΔΗΓΟΥ  
length of frame  
ΥΚ = ΥΨΟΣ ΟΔΗΓΟΥ  
height of frame  
ΠΦ = ΠΛΑΤΟΣ ΦΥΛΛΟΥ  
length of sash  
ΥΦ = ΥΨΟΣ ΦΥΛΛΟΥ  
height of sash

$$\text{ΠΦ} = (\text{ΠΚ} + 137) / 3$$

$$\text{ΥΦ} = \text{ΥΚ} - 51$$

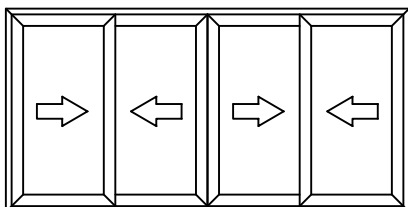
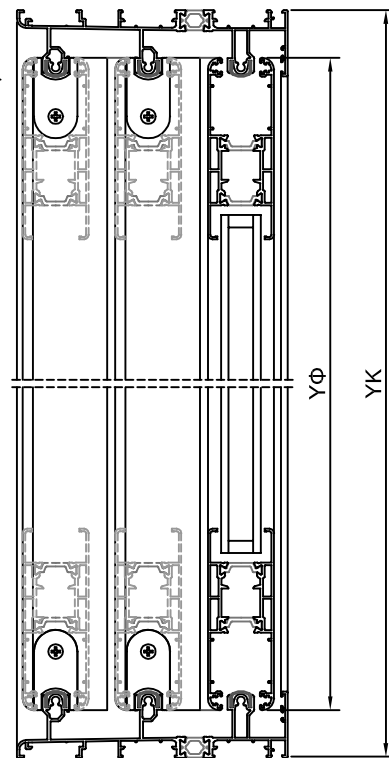
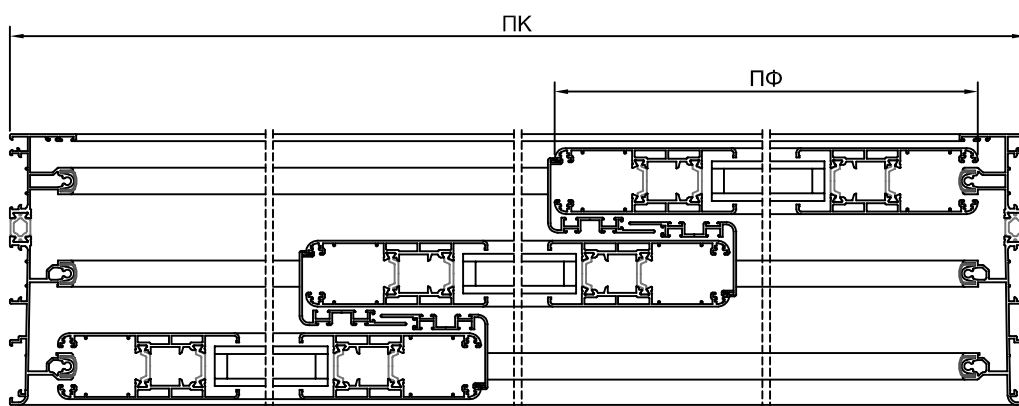

## ΤΕΤΡΑΦΥΛΛΟ ΕΠΑΛΛΗΛΟ

### four sash overlapping

**ΟΔΗΓΟΣ (rail) 16160**

**ΦΥΛΛΟ (sashes) 16250, 16252, 16254**

ΠΚ = ΠΛΑΤΟΣ ΟΔΗΓΟΥ  
length of frame  
ΥΚ = ΥΨΟΣ ΟΔΗΓΟΥ  
height of frame  
ΠΦ = ΠΛΑΤΟΣ ΦΥΛΛΟΥ  
length of sash  
ΥΦ = ΥΨΟΣ ΦΥΛΛΟΥ  
height of sash  
ΥΜ = ΥΨΟΣ ΜΠΙΝΙ  
adaptor 16632

$$\text{ΠΦ} = (\text{ΠΚ} + 130) / 4$$

$$\text{ΥΦ} = \text{ΥΚ} - 51$$

$$\text{ΥΜ} = \text{ΥΚ} - 89$$

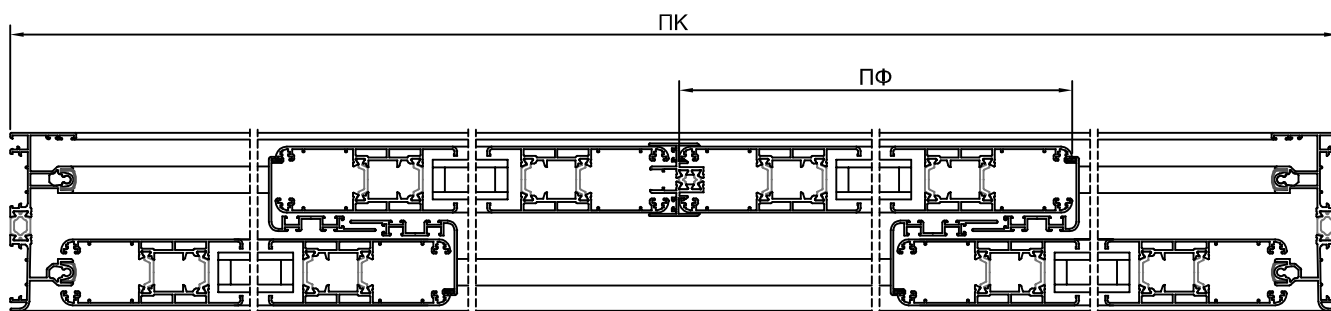
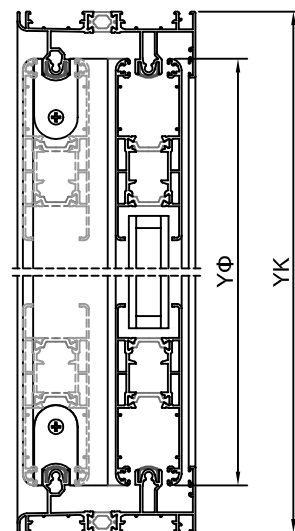



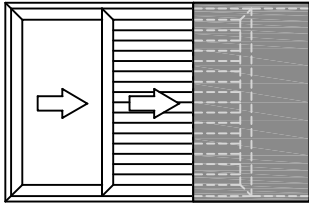

## ΤΖΑΜΙ - ΠΑΤΖΟΥΡΙ ΧΩΝΕΥΤΑ glass - shutter in the wall

ΟΔΗΓΟΣ (rail) 16160

ΦΥΛΛΟ (sashes) 16250, 16252, 16254

ΠΑΤΖΟΥΡΙ (shutter) 7260, 7261

- ΠΚ = ΠΛΑΤΟΣ ΟΔΗΓΟΥ  
length of frame
- ΥΚ = ΥΨΟΣ ΟΔΗΓΟΥ  
height of frame
- ΠΦ = ΠΛΑΤΟΣ ΦΥΛΛΟΥ  
length of sash
- ΥΦ = ΥΨΟΣ ΦΥΛΛΟΥ  
height of sash

$$\text{ΠΦ} = \text{ΠΚ} - 50$$

$$\text{ΥΦ} = \text{ΥΚ} - 51$$

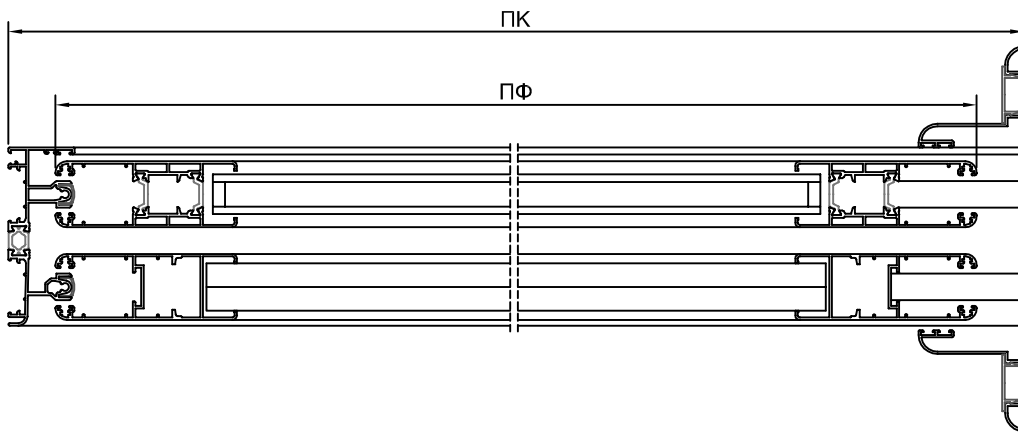

**ΚΟΠΕΣ**  
cutting  
instructions

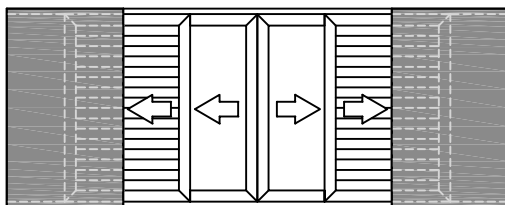
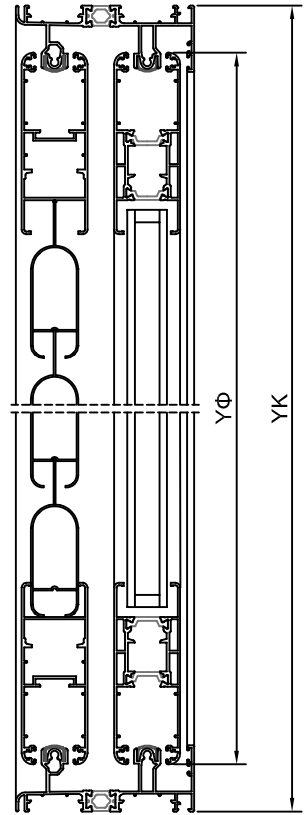

## ΤΖΑΜΙ - ΠΑΤΖΟΥΡΙ ΑΝΤΙΚΡΥΣΤΑ ΧΩΝΕΥΤΑ opposite glass - shutters in the wall

ΟΔΗΓΟΣ (rail) 16160

ΦΥΛΛΟ (sashes) 16250, 16252, 16254

ΠΑΤΖΟΥΡΙ (shutter) 7260, 7261

- ΠΚ = ΠΛΑΤΟΣ ΟΔΗΓΟΥ  
length of frame
- ΥΚ = ΥΨΟΣ ΟΔΗΓΟΥ  
height of frame
- ΠΦ = ΠΛΑΤΟΣ ΦΥΛΛΟΥ  
length of sash
- ΥΦ = ΥΨΟΣ ΦΥΛΛΟΥ  
height of sash
- ΥΜ = ΥΨΟΣ ΜΠΙΝΙ  
height of adaptor  
16632 & 7634

$$\text{ΠΦ} = (\text{ΠΚ} - 57) / 2$$

$$\text{ΥΦ} = \text{ΥΚ} - 51$$

$$\text{ΥΜ} = \text{ΥΚ} - 89$$

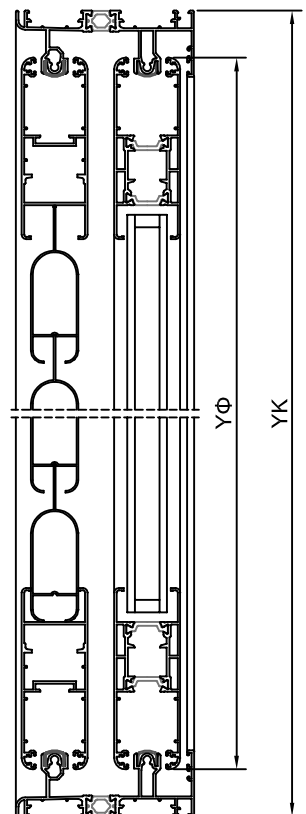
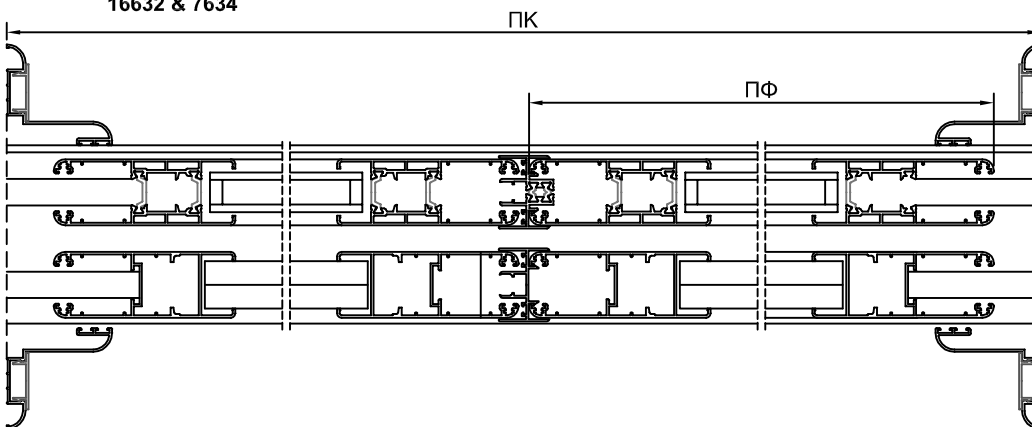

## GN 601

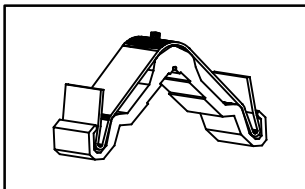

ΓΩΝΙΑ ΣΥΝΔΕΣΗΣ ΧΥΤΗ  
ΓΙΑ ΤΑ ΦΥΛΛΑ  
16250, 16252

cast corner  
bracket for sash  
16250, 16252

## GN 2510

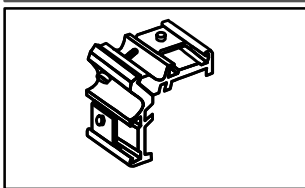

ΓΩΝΙΑ ΣΥΝΔΕΣΗΣ  
ΑΛΟΥΜΙΝΙΟΥ ΓΙΑ ΤΑ  
ΦΥΛΛΑ 7260, 7261

aluminium corner  
bracket for sash  
7260, 7261

## GN 2540

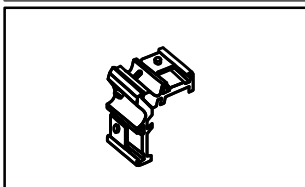

ΓΩΝΙΑ ΣΥΝΔΕΣΗΣ ΑΛΟΥ-  
ΜΙΝΙΟΥ ΓΙΑ ΤΟ ΦΥΛΛΟ  
ΣΗΤΑΣ 7270

aluminium corner  
bracket for insect  
screen frame 7270

## GN 602

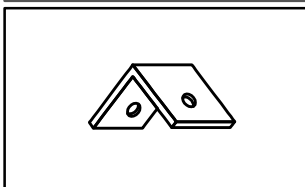

ΓΩΝΙΑ ΣΥΝΔΕΣΗΣ ΑΛΟΥΜ.  
ΓΙΑ ΟΔΗΓΟΥΣ 16160,  
16162, 16164, 16166

aluminium corner bracket  
for rails 16160, 16162  
16164, 16166

## AC 420

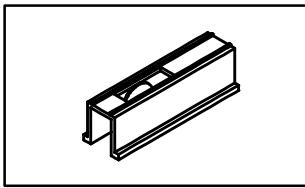

ΜΟΝΟ ΡΑΟΥΛΟ  
ΓΙΑ ΟΛΑ ΤΑ ΦΥΛΛΑ

single aluminium roller  
for all sashes

## AC 422

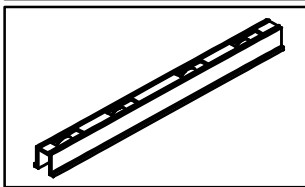

ΤΕΤΡΑΠΛΟ ΡΑΟΥΛΟ  
ΓΙΑ ΟΛΑ ΤΑ ΦΥΛΛΑ

quadruple aluminium  
roller for all sashes

## AC 426

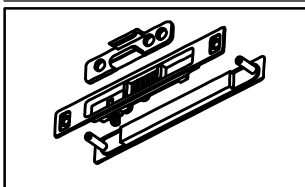

ΚΛΕΙΔΑΡΙΑ ΧΩΝΕΥΤΗ

lock for sliding  
doors & windows

ΓΩΝΙΑ ΣΥΝΔΕΣΗΣ ΧΥΤΗ  
ΓΙΑ ΤΑ ΦΥΛΛΑ  
7260, 7261

cast corner  
bracket for sash  
7260, 7261

ΓΩΝΙΑ ΣΥΝΔΕΣΗΣ ΧΥΤΗ  
ΓΙΑ ΤΟ ΦΥΛΛΟ ΣΗΤΑΣ  
7270

cast corner bracket  
for insect screen  
frame 7270

ΑΝΟΞΕΙΔΩΤΗ ΓΩΝΙΑ  
ΕΠΙΠΕΔΟΤΗΤΑΣ

alignment corner

ΓΩΝΙΑ ΣΥΝΔΕΣΗΣ  
ΑΛΟΥΜΙΝΙΟΥ ΓΙΑ  
ΟΔΗΓΟΥΣ 16168, 16169

aluminium corner  
bracket for rails  
16168, 16169

ΔΙΠΛΟ ΡΑΟΥΛΟ  
ΓΙΑ ΟΛΑ ΤΑ ΦΥΛΛΑ

double aluminium roller  
for all sashes

ΜΟΝΟ ΡΑΟΥΛΟ  
ΑΛΟΥΜΙΝΙΟΥ  
ΣΗΤΑΣ 7270

aluminium single  
roller for insect  
screen frame 7270

ΧΟΥΦΤΑ

handle for sliding  
doors & windows

## GN 210

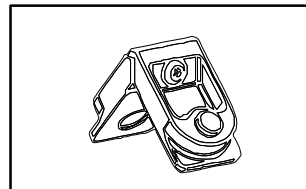

## GN 410

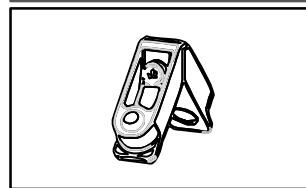

## GN 213

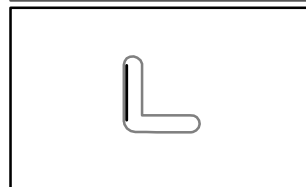

## GN 612

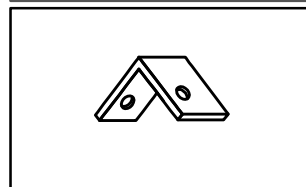

## AC 421

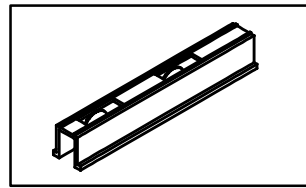

## AC 423

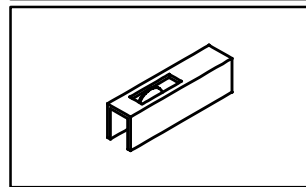

## AC 427

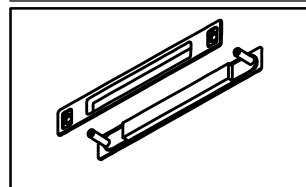

**ΕΞΑΡΤΗΜΑΤΑ**  
accessories

**AC 428**

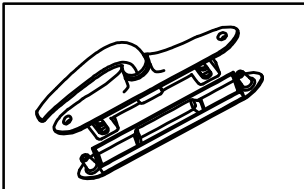

ΚΛΕΙΔΑΡΙΑ ΜΕ  
ΣΠΑΝΙΟΛΕΤΑ

espagnolette lock  
for sliding doors &  
windows

**AC 610**

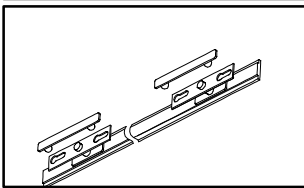

ΝΤΙΖΑ ΜΕ ΚΙΤ 4  
ΚΛΕΙΔΩΜΑΤΩΝ ΓΙΑ  
ΠΑΡΑΘΥΡΑ

safety multiple  
locking rod for  
windows

**AC 612**

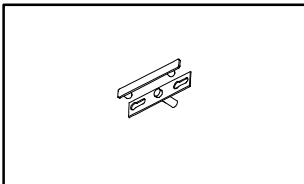

ΚΙΤ ΚΛΕΙΔΩΜΑΤΟΣ  
ΓΙΑ ΠΑΡΑΘΥΡΑ

Double point locking rod  
for windows

**AC 613**

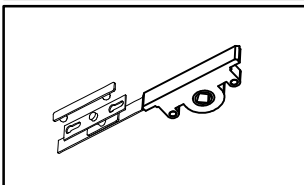

ΚΙΤ ΚΑΡΕ

Double point  
karre mechanism kit

**AC 615**

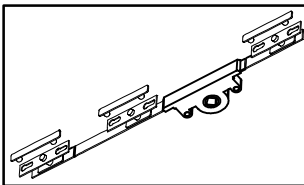

ΝΤΙΖΑ ΚΑΡΕ ΕΞΑΠΛΟΥ  
ΚΛΕΙΔΩΜΑΤΟΣ ΓΙΑ  
ΠΑΡΑΘΥΡΑ

Six point  
karre mechanism kit

**SL 83**

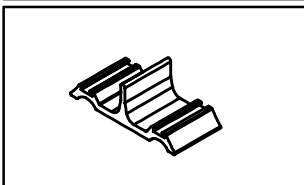

ΣΤΟΠΕΡ ΑΝΤΙΚΡΥΣΤΩΝ  
ΦΥΛΛΩΝ (ΦΙΛΗΤΑ)  
ΓΙΑ ΟΔΗΓΟ 16166

stopper for opposite  
sashes (rail 16166)

**PL 623**

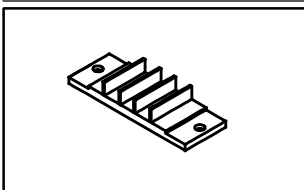

ΤΑΚΟΣ ΣΤΕΓΑΝΩΣΗΣ  
ΕΠΑΛΛΗΛΟΥ

head & sill weather  
seal

ΜΠΟΥΤΟΝ

button operated  
safety lock

ΝΤΙΖΑ ΜΕ ΚΙΤ 6  
ΚΛΕΙΔΩΜΑΤΩΝ ΓΙΑ  
ΜΠΑΛΚΟΝΟΠΟΡΤΕΣ

safety multiple  
locking rod for  
doors

ΣΠΑΝΙΟΛΕΤΑ ΓΙΑ ΚΙΤ ΚΑΡΕ

Espagnolette for  
karre mechanism kit  
AC 613, AC614, AC615

ΝΤΙΖΑ ΚΑΡΕ ΤΕΤΡΑΠΛΟΥ  
ΚΛΕΙΔΩΜΑΤΟΣ ΓΙΑ  
ΠΑΡΑΘΥΡΑ

Four point  
kare mechanism kit

ΣΤΟΠΕΡ ΑΝΤΙΚΡΥΣΤΩΝ  
ΦΥΛΛΩΝ (ΦΙΛΗΤΑ)  
ΓΙΑ ΟΔΗΓΟ 16160

stopper for opposite  
sashes (rail 16160)

ΣΤΟΠΕΡ ΑΝΤΙΚΡΥΣΤΩΝ  
ΦΥΛΛΩΝ (ΦΙΛΗΤΑ)  
ΓΙΑ ΟΔΗΓΟ 16168

stopper for opposite  
sashes (rail 16168)

ΑΜΟΡΤΙΣΕΡ ΦΥΛΛΟΥ

plastic buffer for sash

**AC 429**

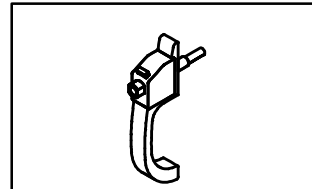

**AC 611**

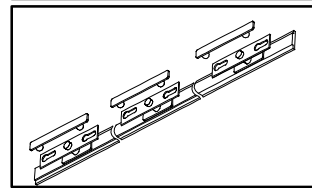

**AC 430**

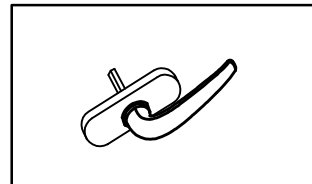

**AC 614**

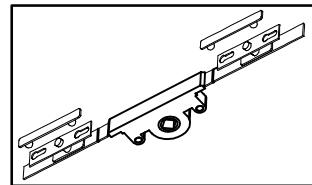

**SL 81**

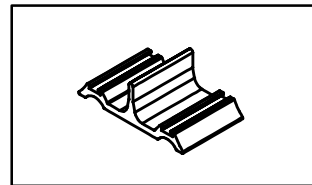

**SL 84**

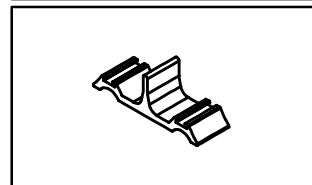

**PL 430**

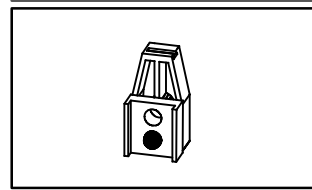

## ΕΞΑΡΤΗΜΑΤΑ accessories

**PL 626**



ΑΜΟΡΤΙΣΕΡ ΦΥΛΛΟΥ  
ΡΥΘΜΙΖΟΜΕΝΟ

adjustable plastic buffer  
for sash

**PL 140**



ΠΛΑΣΤΙΚΗ ΤΑΠΑ  
ΓΑΝΤΖΟΥ

top & bottom plastic  
plug for hook profile

**PL 624**

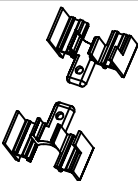

ΠΛΑΣΤΙΚΗ ΤΑΠΑ ΜΠΙΝΙΟΥ  
ΑΝΤΙΚΡΥΣΤΩΝ ΦΥΛΛΩΝ  
(ΣΕΤ)

top & bottom plastic  
plug for adaptor

**PL 625**



ΜΟΝΩΤΙΚΗ ΠΡΟΣΘΗΚΗ  
ΟΔΗΓΩΝ 16160, 16162,  
16164

Inner rail insulating  
profile for rails 16160,  
16162, 16164

**PL 628**



ΜΟΝΩΤΙΚΗ ΠΡΟΣΘΗΚΗ  
ΟΔΗΓΩΝ 16169

Inner rail insulating  
profile for rail 16169



**LA 611**



ΛΑΣΤΙΜΟ ΜΟΝΩΣΗΣ  
ΟΔΗΓΩΝ 16160, 16162,  
16164, 16166, 16169

Outer frame insulating  
gasket for rails 16160  
16162, 16164, 16166  
16169

**LA 701 LA 702**

ΜΑΥΡΟ  
black

ΛΕΥΚΟ  
white

ΛΑΣΤΙΧΟ ΣΗΤΑΣ

rubber rod for  
screen mesh

**PL 431**



ΑΜΟΡΤΙΣΕΡ ΣΗΤΑΣ  
ΦΥΛΛΟΥ 7270

plastic buffer for  
insect screen frame  
7270

**PL 434**

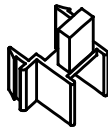

ΠΛΑΣΤΙΚΗ ΤΑΠΑ ΜΠΙΝΙΟΥ  
ΑΝΤΙΚΡΥΣΤΩΝ ΦΥΛΛΩΝ  
ΣΗΤΑΣ

top & bottom plastic  
plug for adaptor  
insect screen frame

**PL 431**



ΑΝΟΞΕΙΔΩΤΟ ΛΑΜΑΚΙ  
ΟΔΗΓΩΝ

inox cap for rails

**PL 627**



ΜΟΝΩΤΙΚΗ ΠΡΟΣΘΗΚΗ  
ΟΔΗΓΩΝ 16166

Inner rail insulating  
profile for rail 16166

**LA 612**



ΛΑΣΤΙΧΟ ΜΟΝΩΣΗΣ  
ΓΑΝΤΖΟΥ

Hook's insulating profile

**LA 613**



ΛΑΣΤΙΜΟ ΜΟΝΩΣΗΣ  
ΟΔΗΓΩΝ 16168, &  
16169 ΕΞΩΤΕΡΙΚΑ

Outer frame insulating  
gasket for rails 16168 &  
16169 out side

**LA 201**



ΦΟΥΣΚΑΚΙ

rubber seal

**ΕΞΑΡΤΗΜΑΤΑ**  
accessories

**VR 411 VR 412**

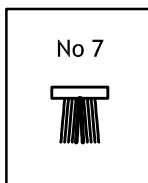
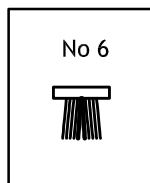

ΒΟΥΡΤΣΑΚΙ ΣΤΕΓΑΝΟΠ.  
ΧΩΡΙΣ ΜΕΜΒΡΑΝΗ

weatherstripping brush  
without membrane

ΒΟΥΡΤΣΑΚΙ ΣΤΕΓΑΝΟΠ.  
ΧΩΡΙΣ ΜΕΜΒΡΑΝΗ Νο8

weatherstripping brush  
without membrane, Νο8

**VR 442**

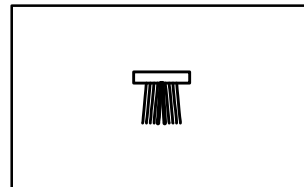

**VR 610**

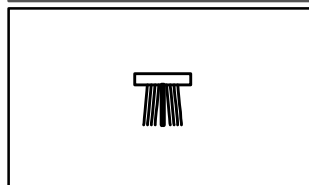

ΒΟΥΡΤΣΑΚΙ ΣΤΕΓΑΝΟΠ.  
ΜΕ ΜΕΜΒΡΑΝΗ Νο 6

weatherstripping brush  
with membrane, Νο 6

ΒΟΥΡΤΣΑΚΙ ΣΤΕΓΑΝΟΠ.  
ΜΕ ΜΕΜΒΡΑΝΗ Νο 7

weatherstripping brush  
with membrane, Νο 7

**VR 611**

