



**ΔΟΥΚΑΣ®**

ΣΥΣΤΗΜΑΤΑ ΑΛΟΥΜΙΝΙΟΥ - ΜΗΧΑΝΗΜΑΤΑ

# Κάγκελα & Σκάλες Σιδήρου









# Καγκελα Περίφραξης



**ΔΟΥΚΑΣ®**

ΣΥΣΤΗΜΑΤΑ ΑΛΟΥΜΙΝΙΟΥ - ΜΗΧΑΝΗΜΑΤΑ

2/1





3/2



4/2



5/2



6/2



7/2



8/2

καγκελα περιφραξης





9/3

κάγκελα περίφραξης



10/3



11/3



12/3



13/3



14/3





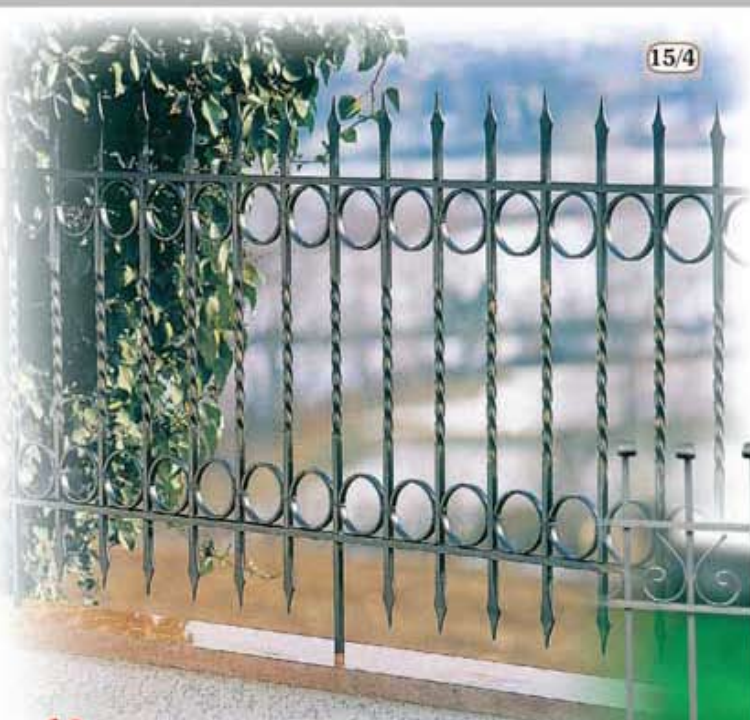

15/4



16/4

κόγκελα περιφραξης



17/4

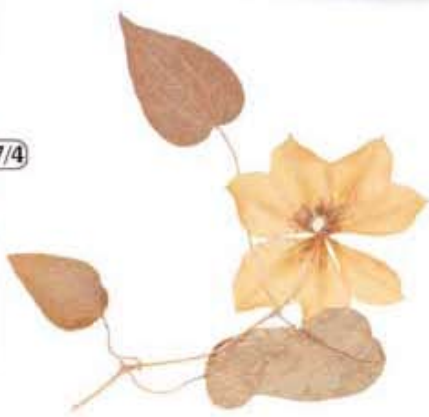













27

489/7



502/7







# Κάγκελα Μπαλκονιών



18/9



19/9





**ΚΑΥΚΕΛΑ ΜΠΑΛΚΟΝΙΩΝ**



20/10



21/10





22/11

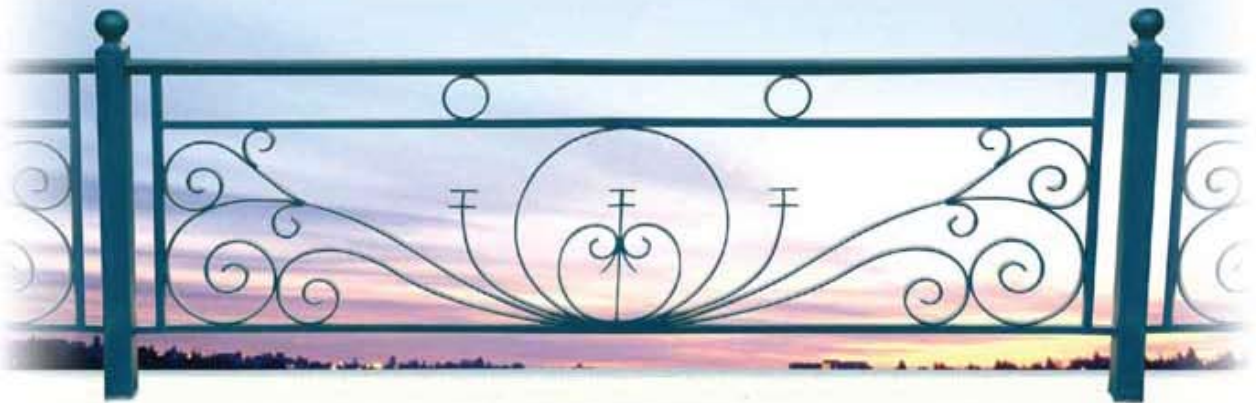

23/11





24/12



25/12



26/12



27/12



28/12



29/12

**ΚΥΚΕΛΑ ΜΠΑΛΚΟΝΙΩΝ**





30/13



31/13



32/13

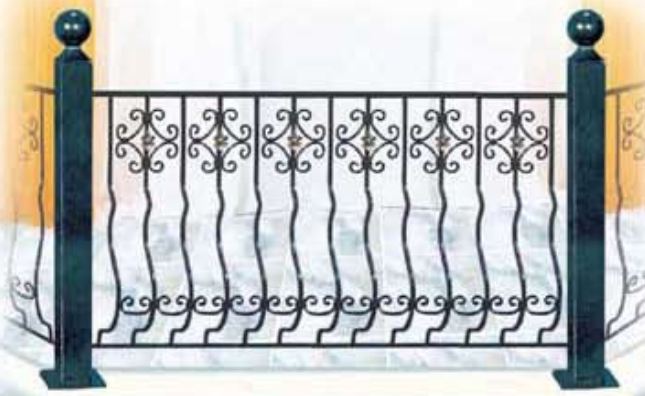

33/13



34/13





35/14



36/14

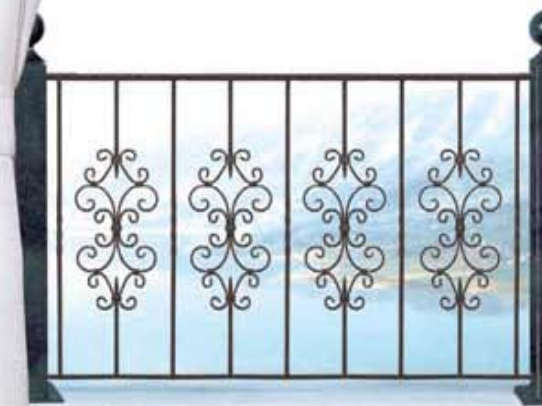

37/14



38/14



39/14



40/14

**ΚΑΓΚΕΛΑ ΜΠΑΛΚΟΝΙΩΝ**



κάγκελα μπαλκονιών



41/15



42/15



43/15

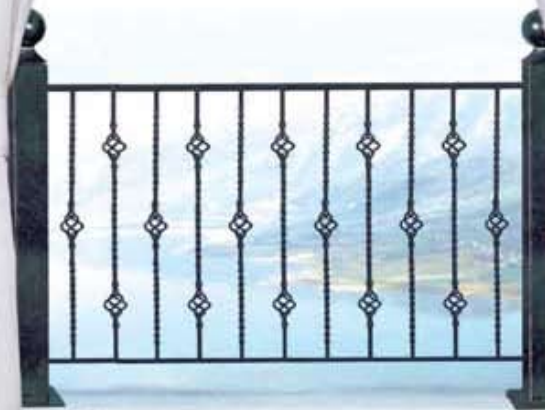

44/15

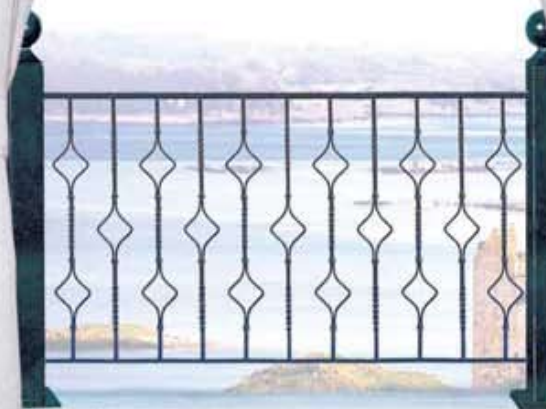

45/15

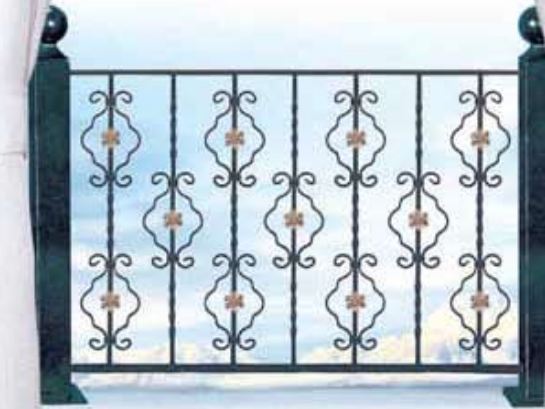

46/15







510/16

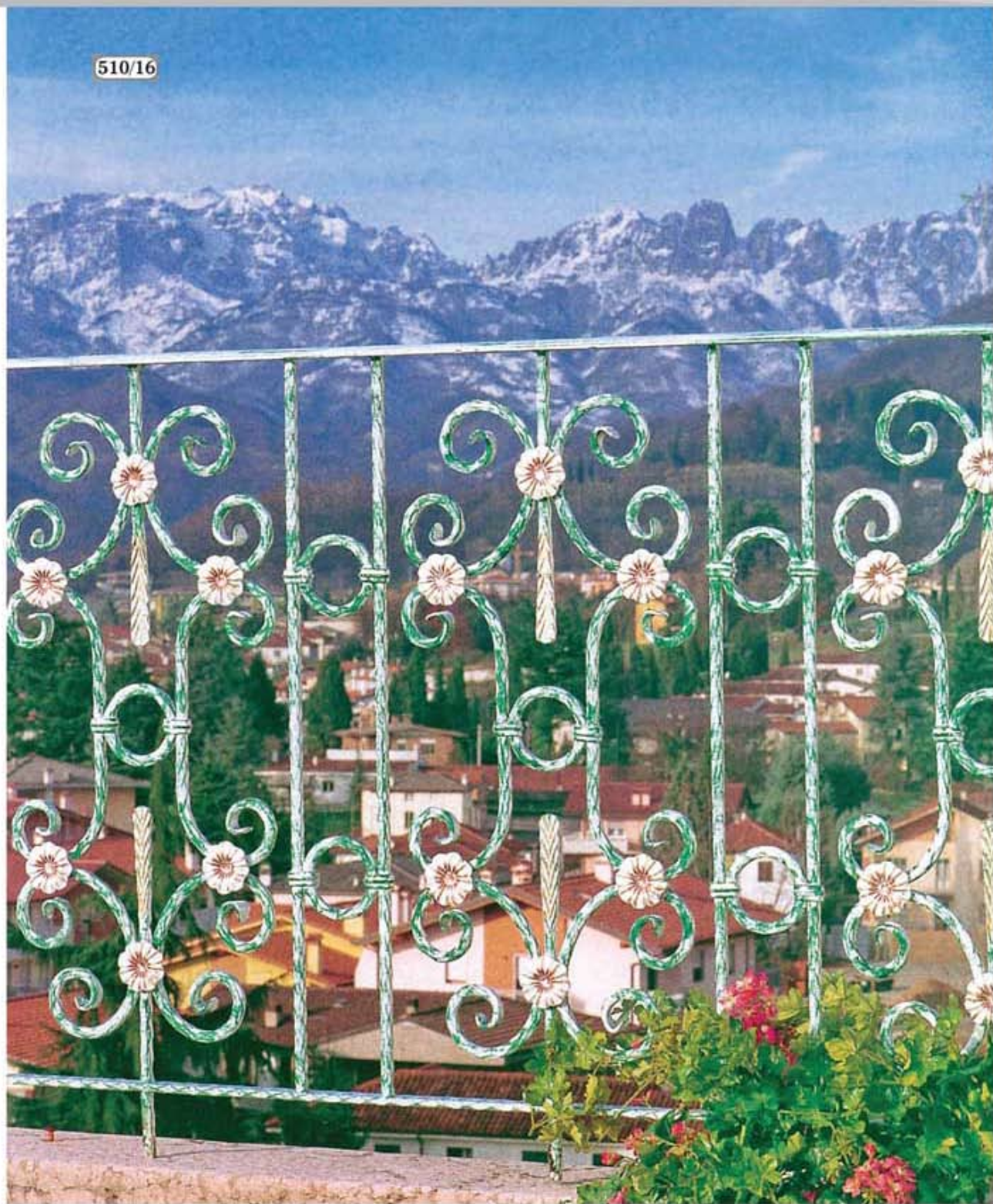



527/17

∅ 8 mm  
1.030 kg  
G 300 x Y 300 mm

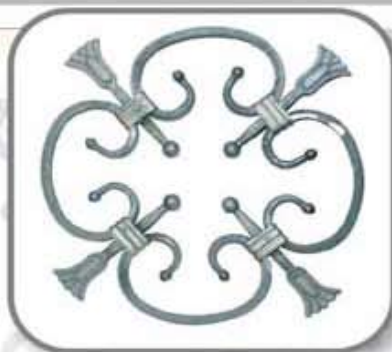

528/17



539/17

∅ 12/14 mm





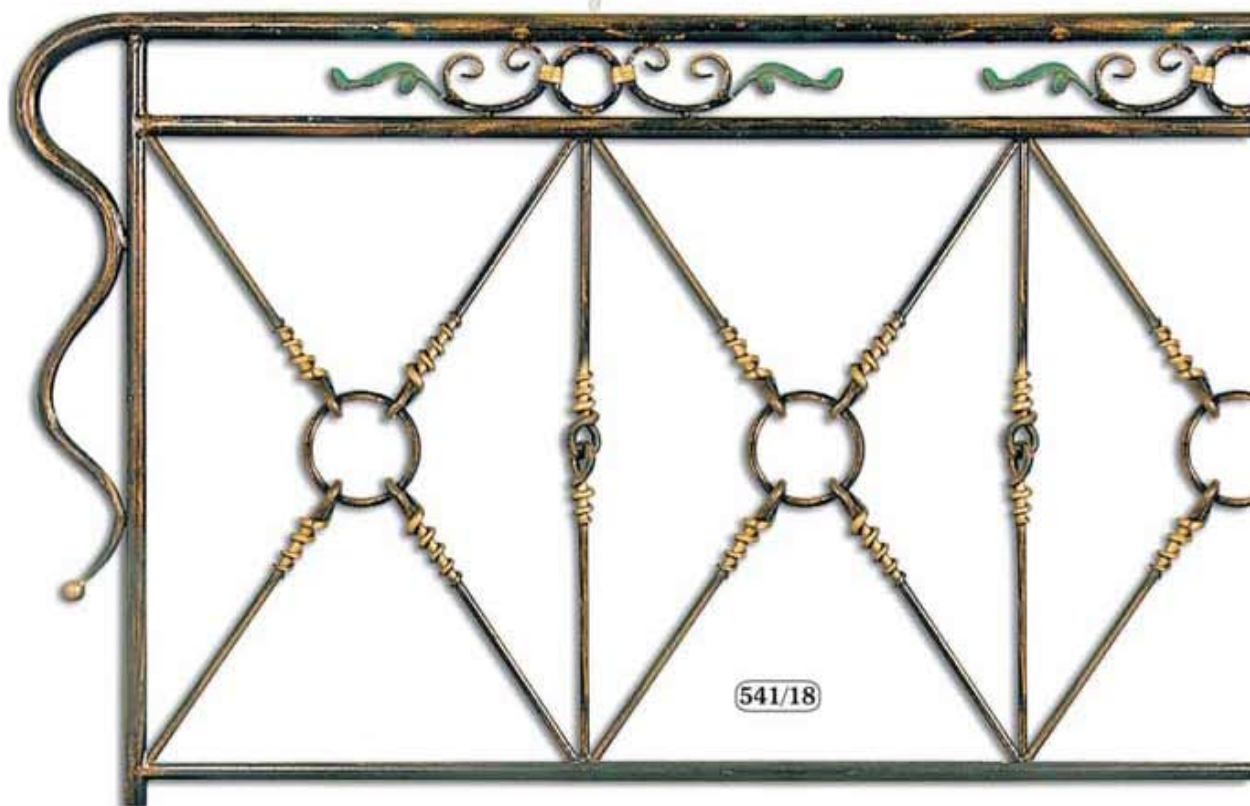





542/19

∅ 12 mm  
G x Y mm  
160 x 575 x 800



543/19

∅ 12 mm  
G x Y mm  
185 x 590 x 800



544/19



545/19







555/20

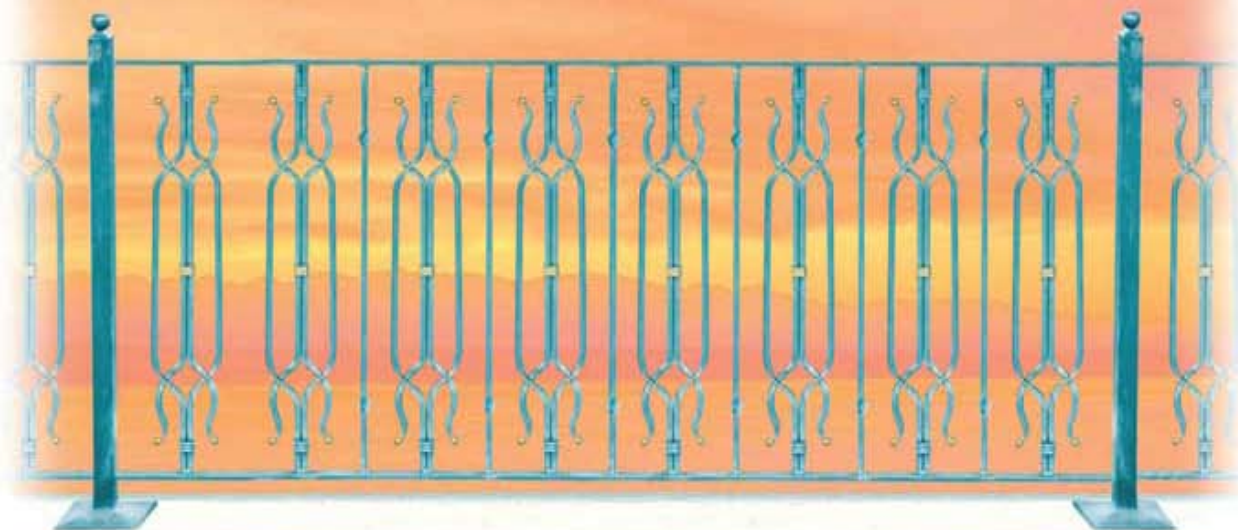

556/20





557/21

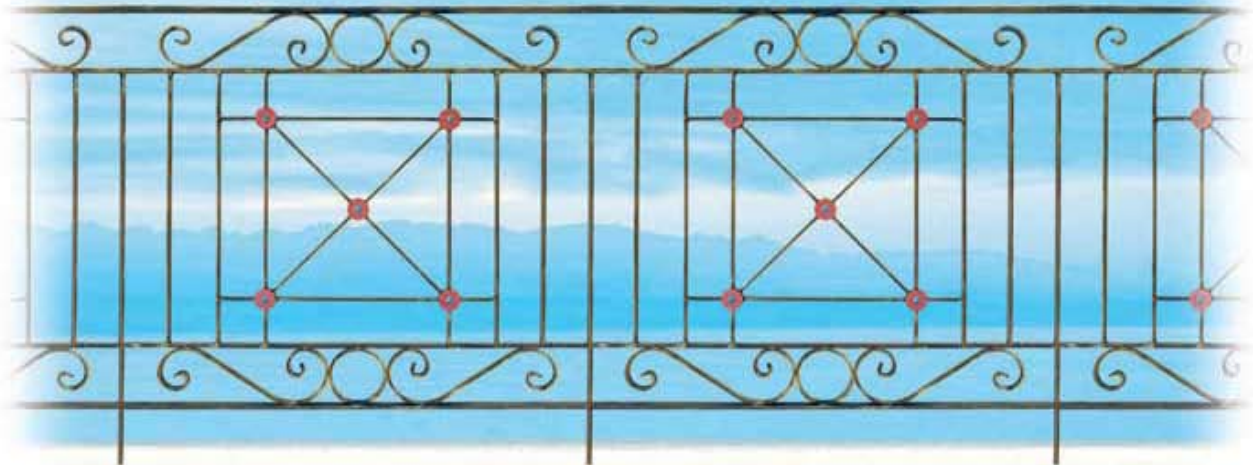

558/21

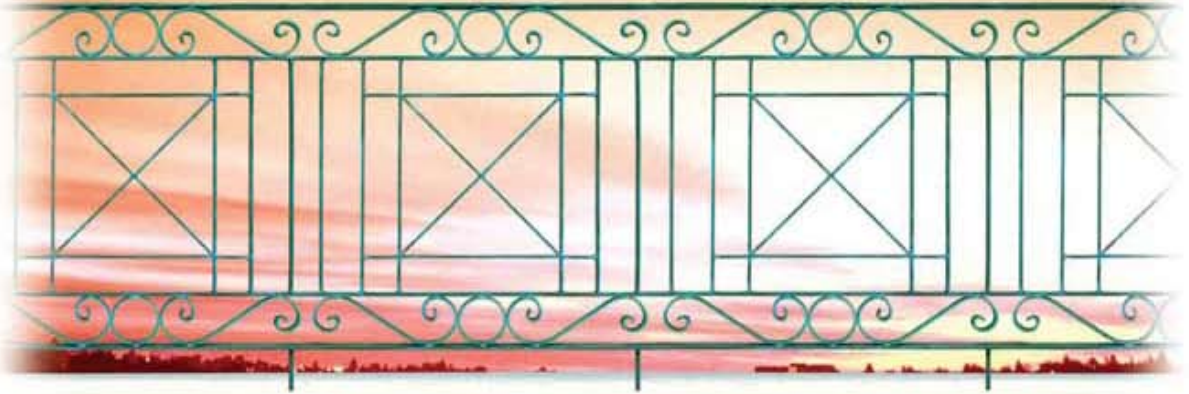

559/22

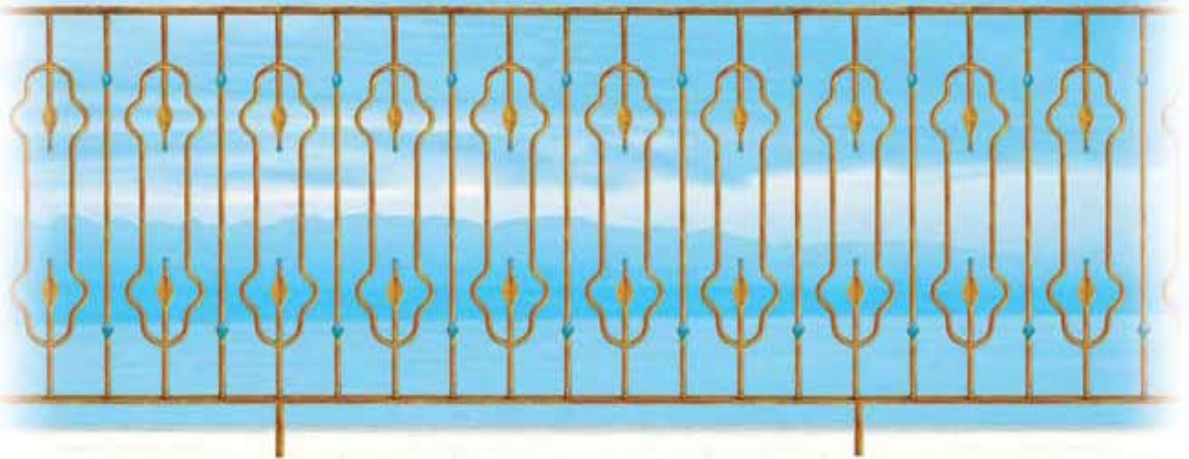

560/22





561/23



562/23

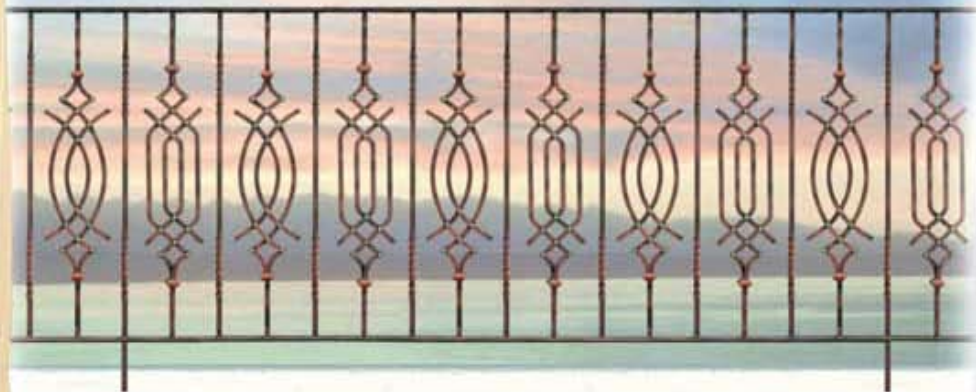

563/24

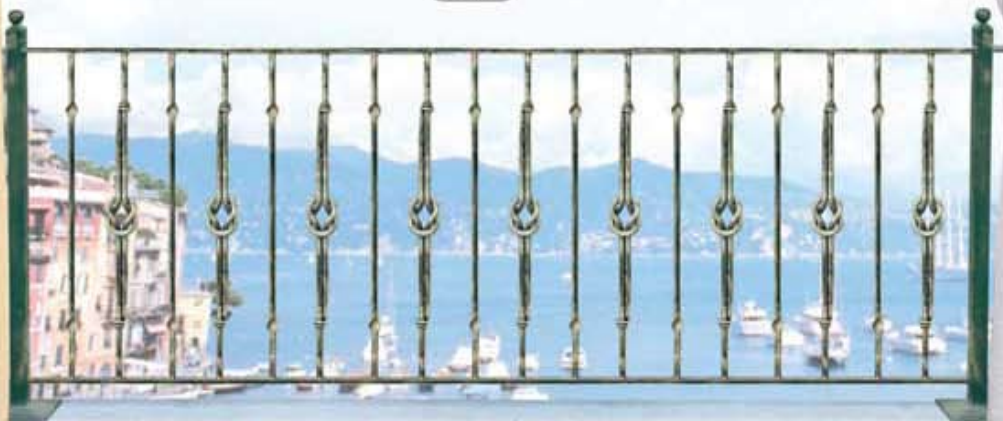

564/24



565/24





566/25

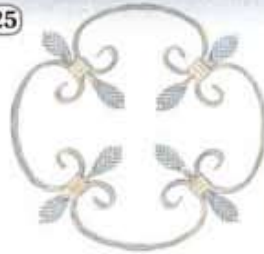

567/25





568/26



569/26





570/27



571/27

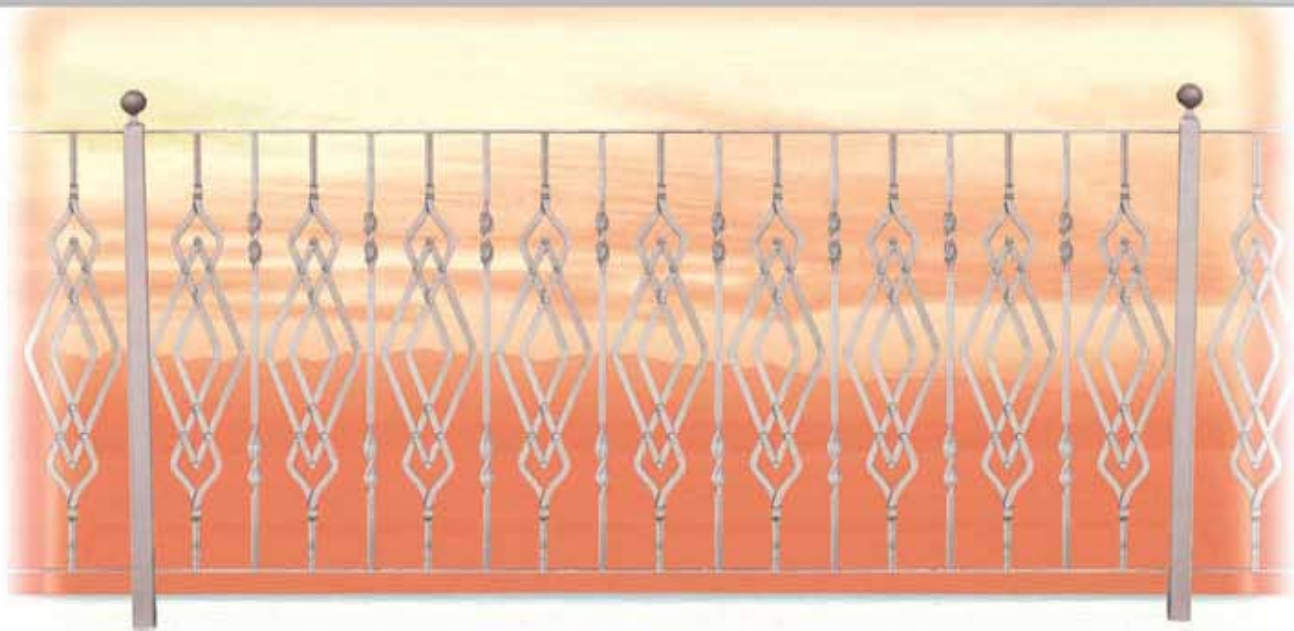

572/28



573/28





574/29



575/29



576/30



577/30





578/31



579/31

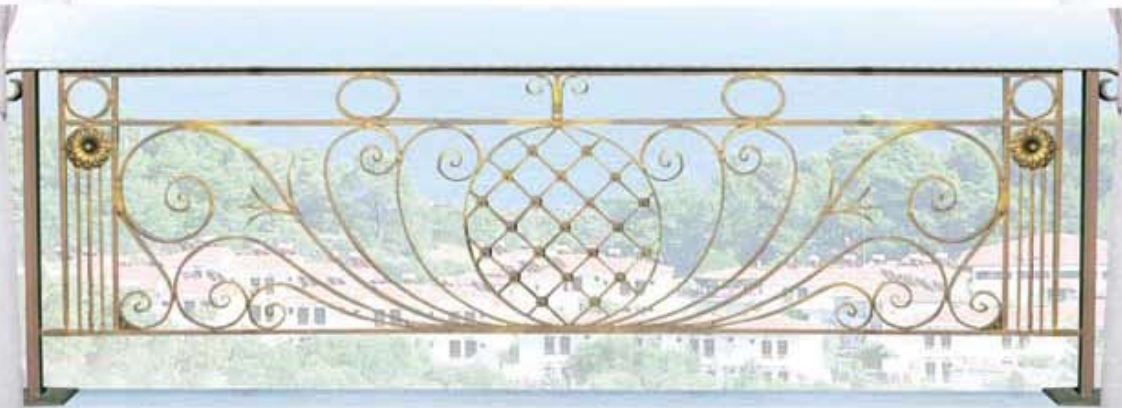

580/31



581/32

581A/32



582/32

581B/32

582A/32



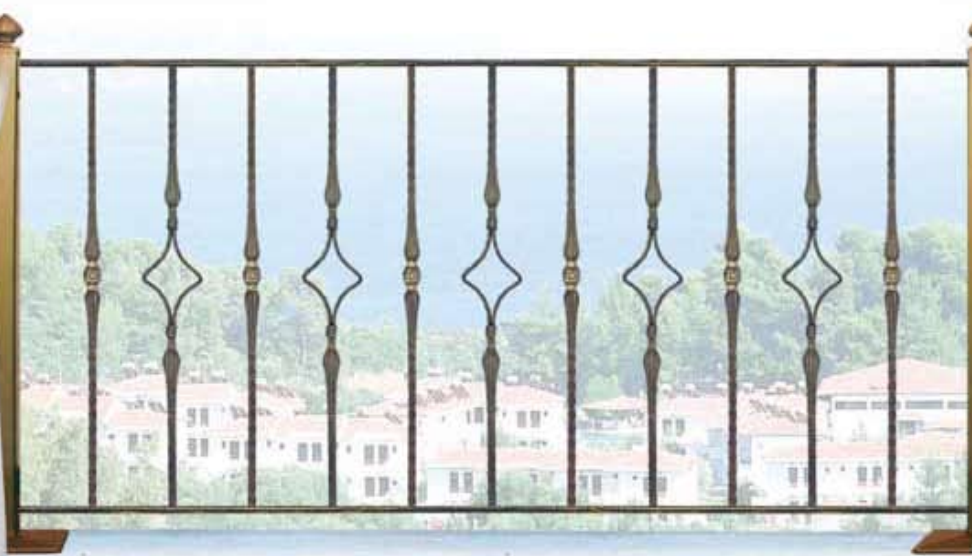

583/33



585/33

584/33

586/33

Παράγονται σε 12X12 ή 14X14 σε απλό ή σφυρήλατο



**ΔΟΥΚΑΣ**  
ΣΥΣΤΗΜΑΤΑ ΑΣΦΑΛΙΣΤΩΝ - ΜΟΣΧΑΚΙΩΤΑ



587/34

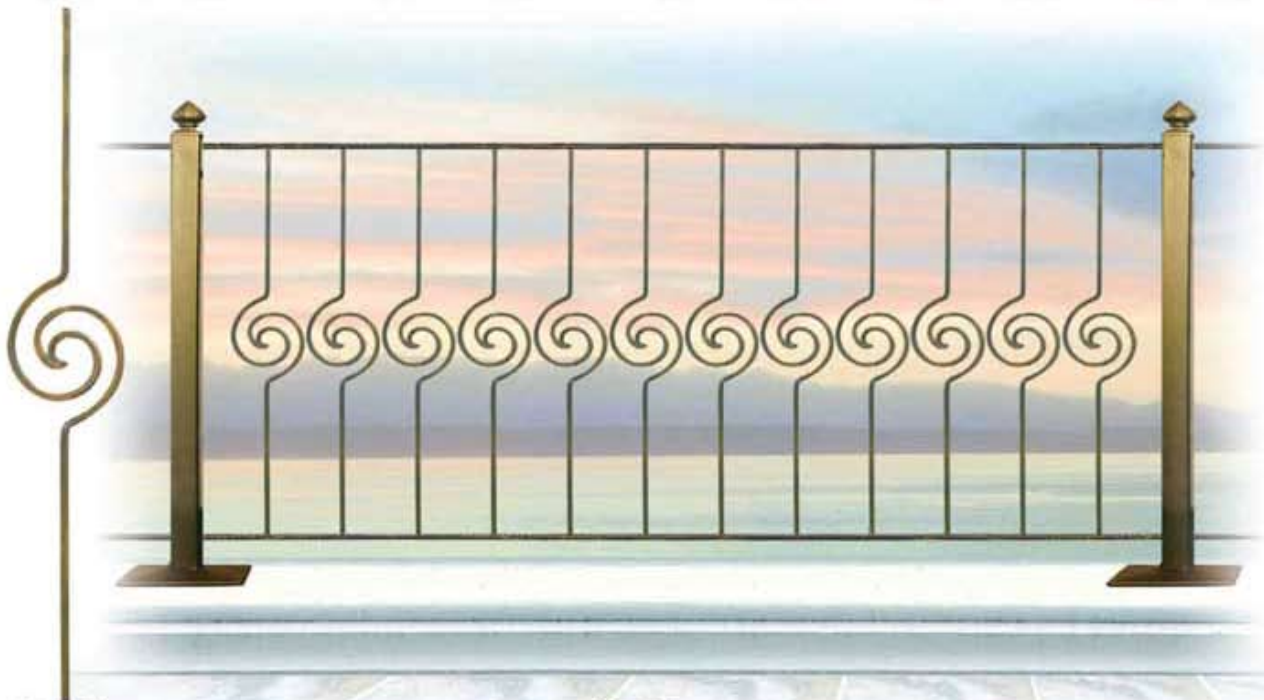

588/34

589/34





599/35

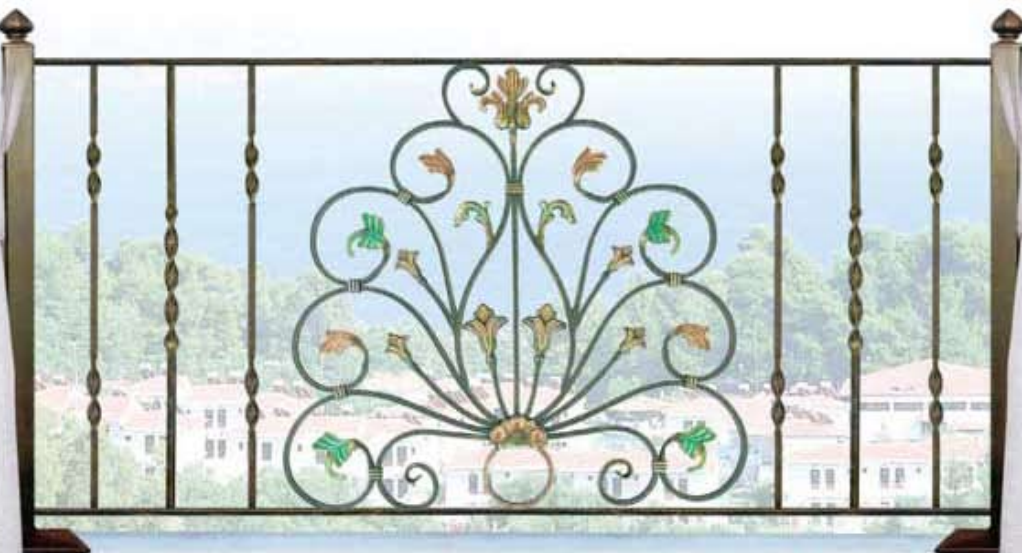

600/35

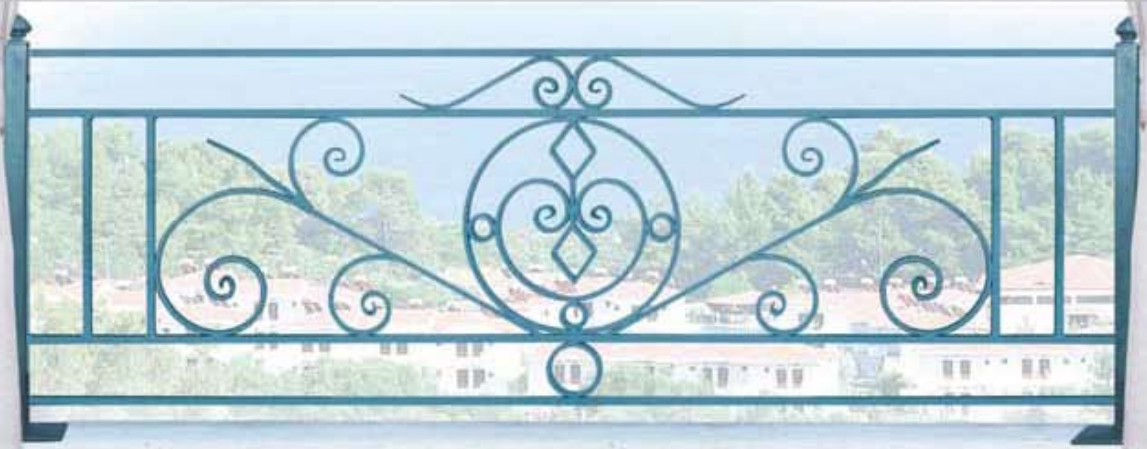

601/36



602/36



603/36



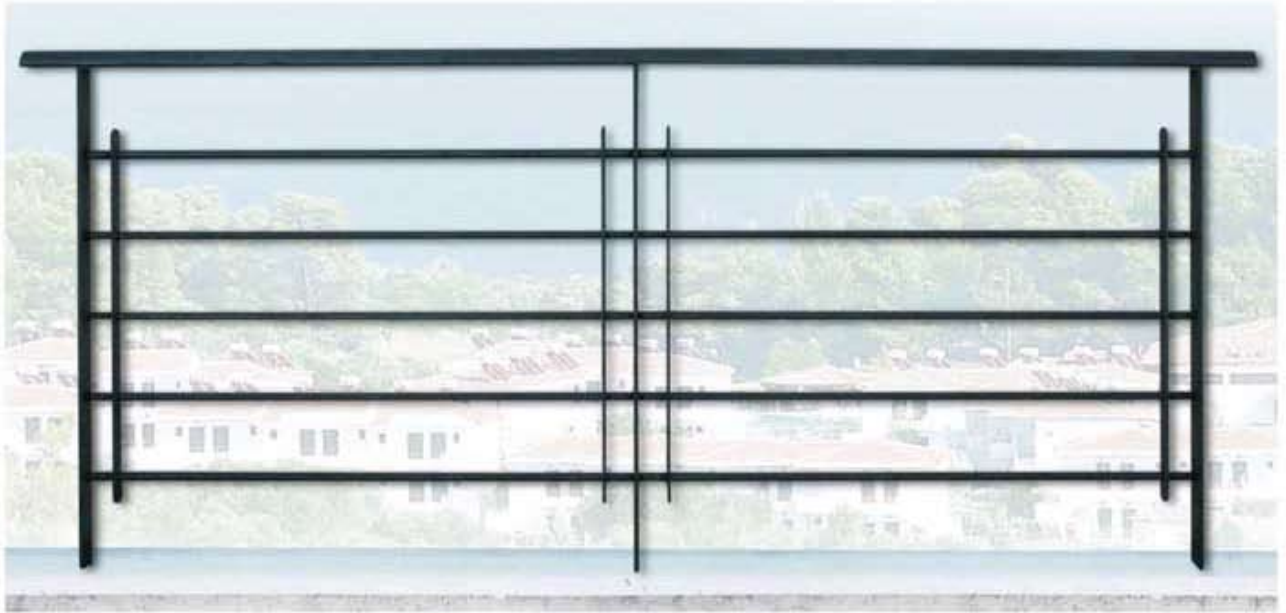

1/37



2/37





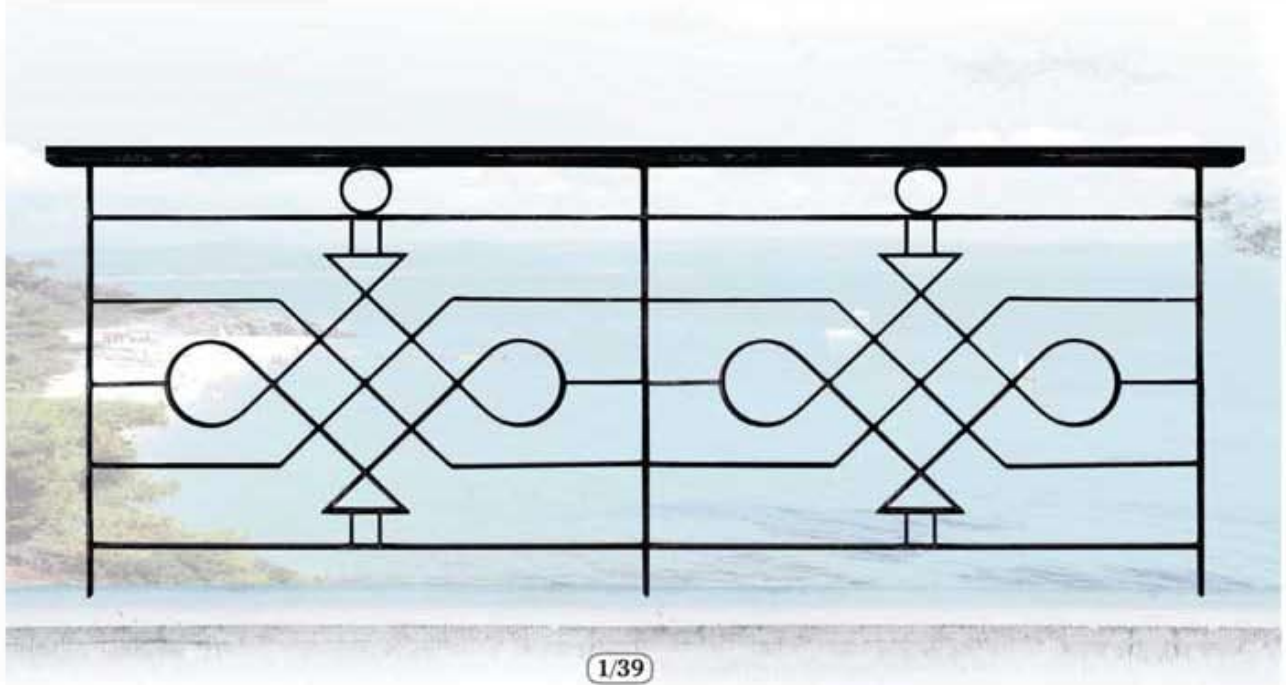

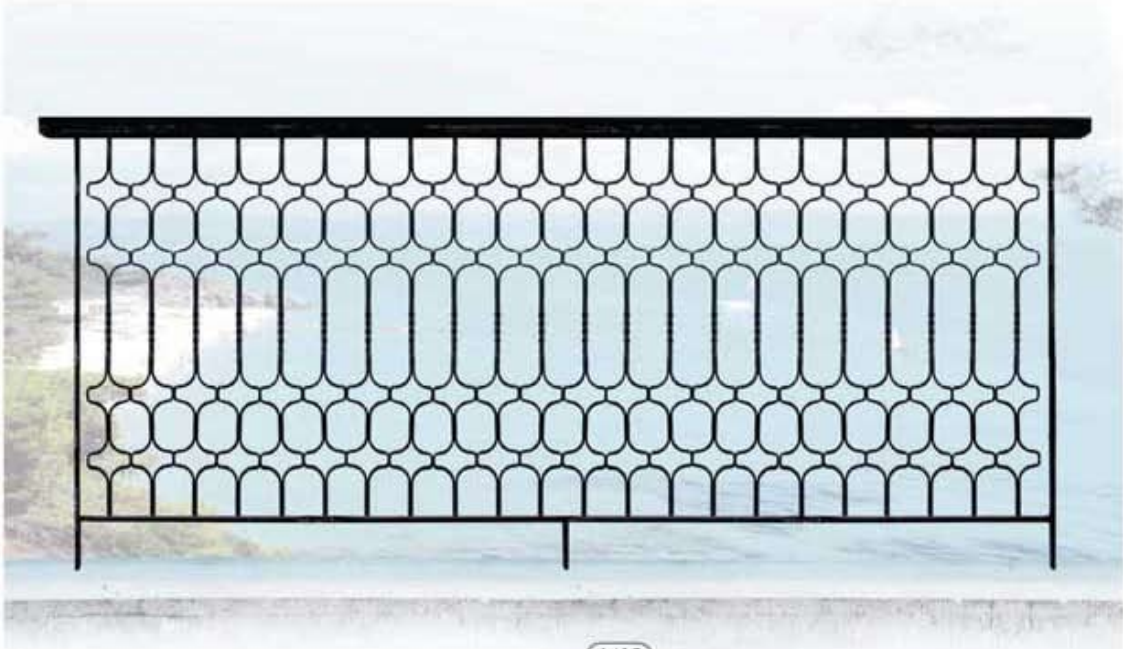

1/40



2/40



3/40



4/40







1/42



2/42



512/43







1/44



2/44





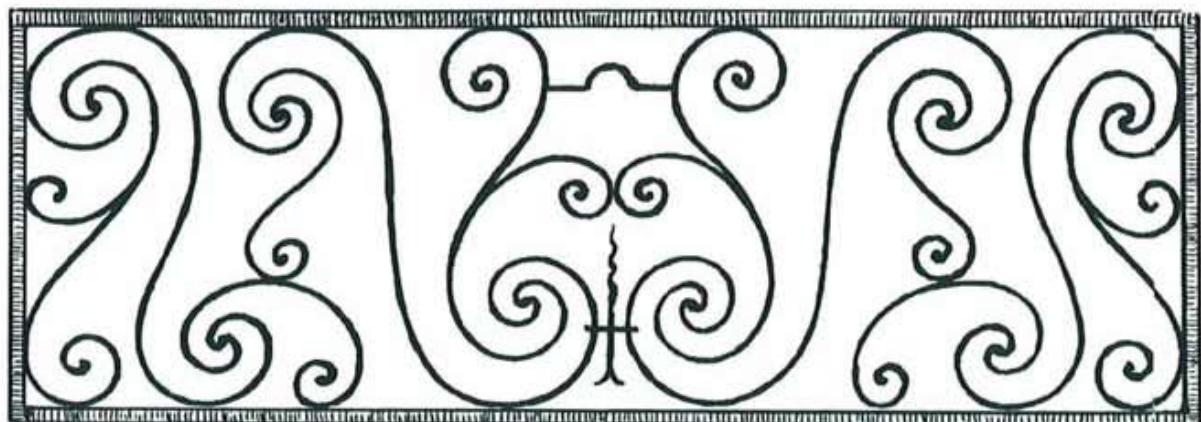

1/46

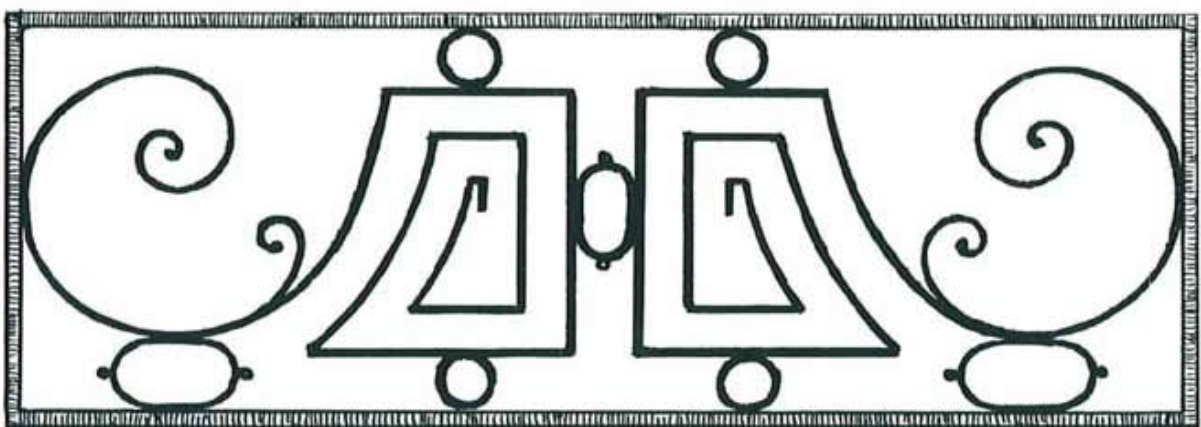

2/46



3/46



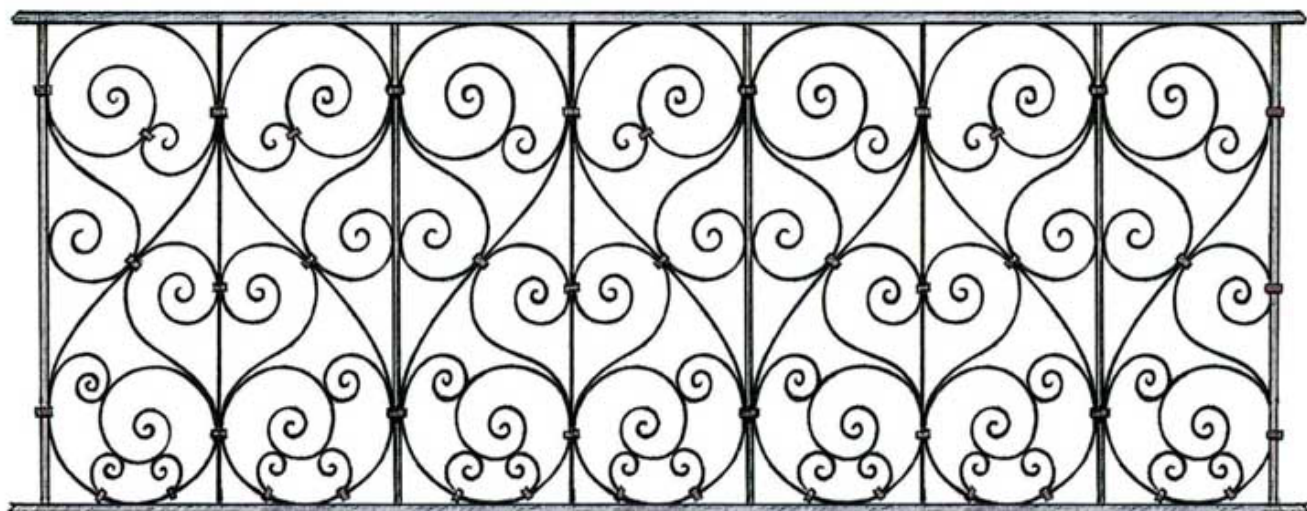

1/47

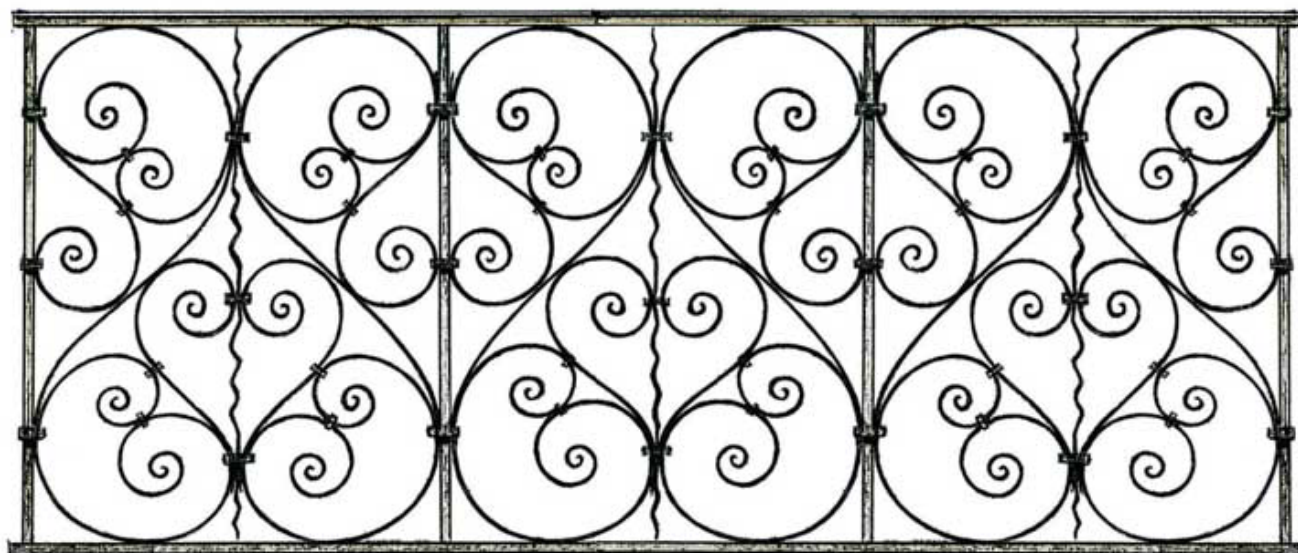

2/47

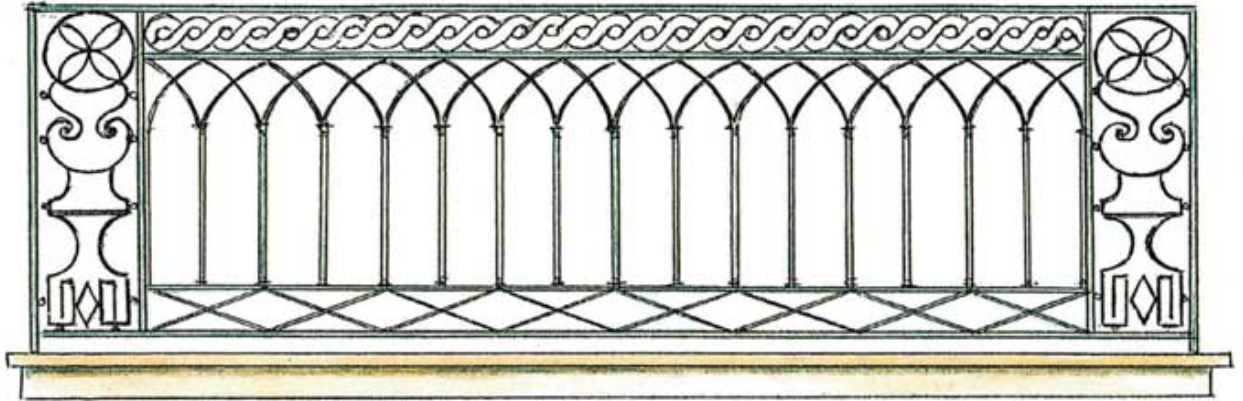

1/48

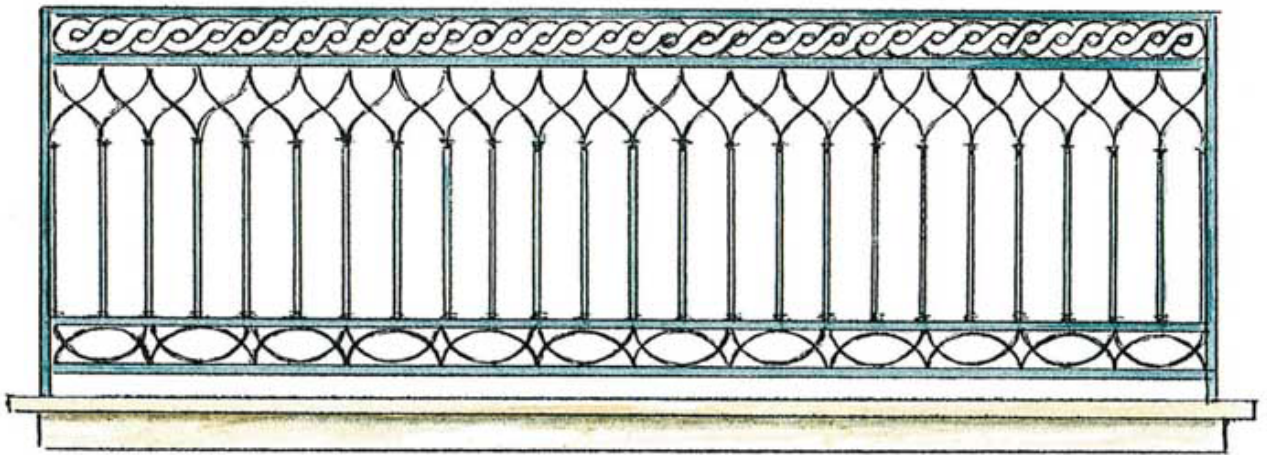

2/48

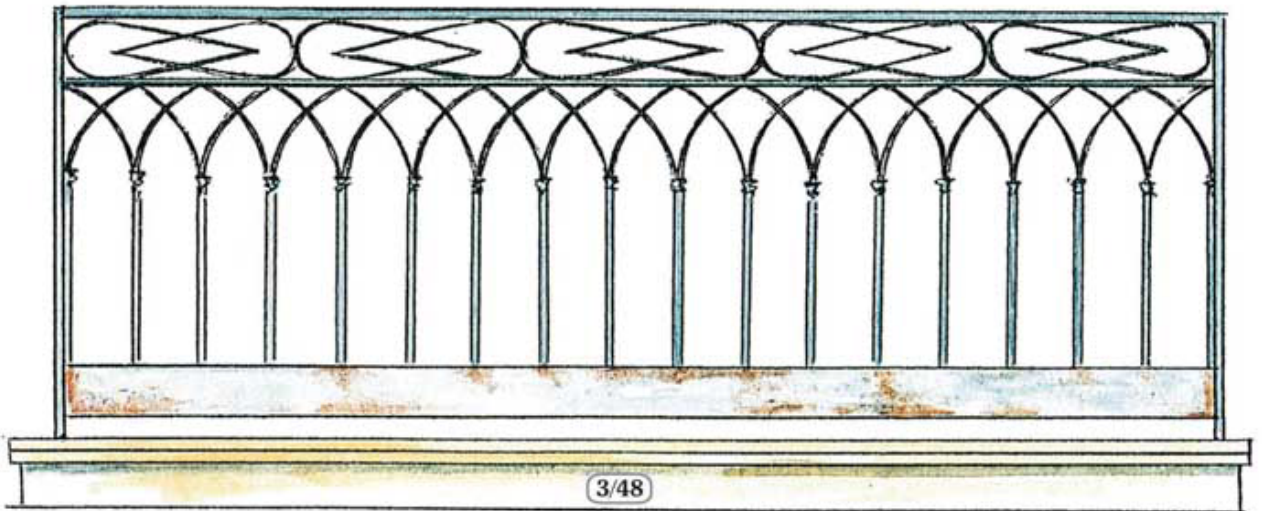

3/48



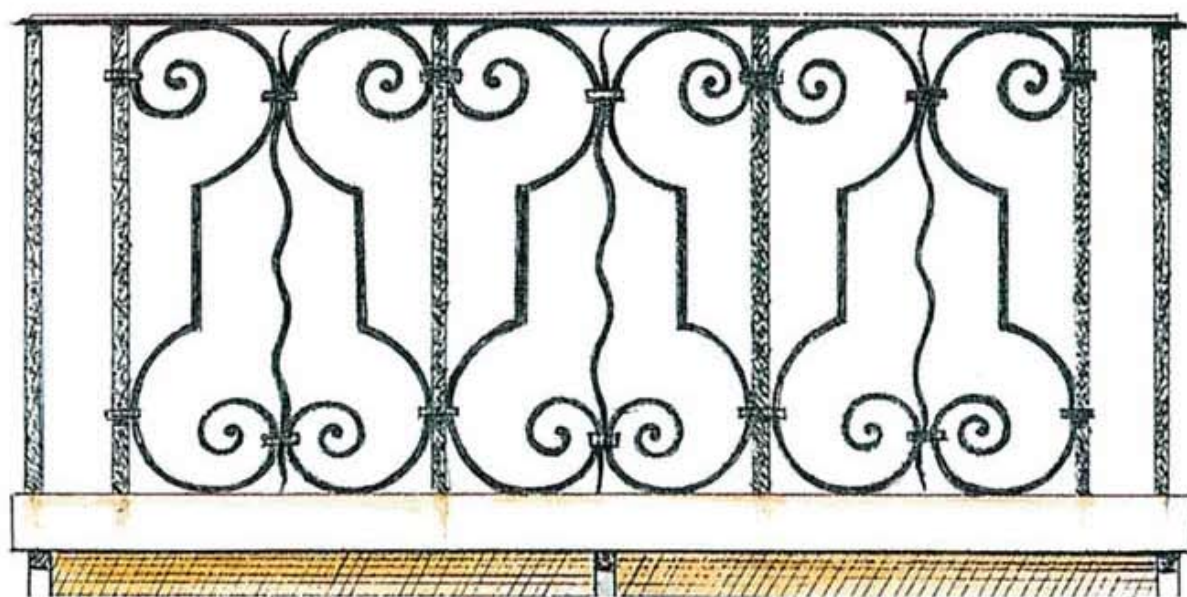

2/49

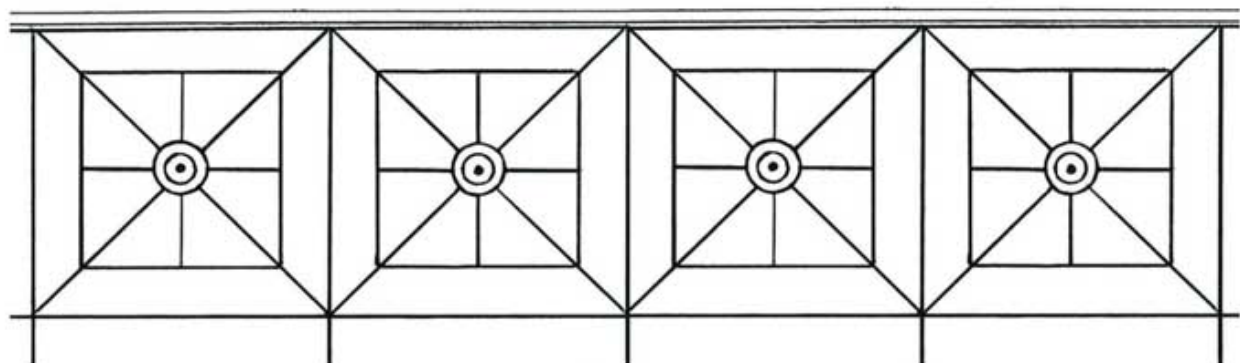

1/50

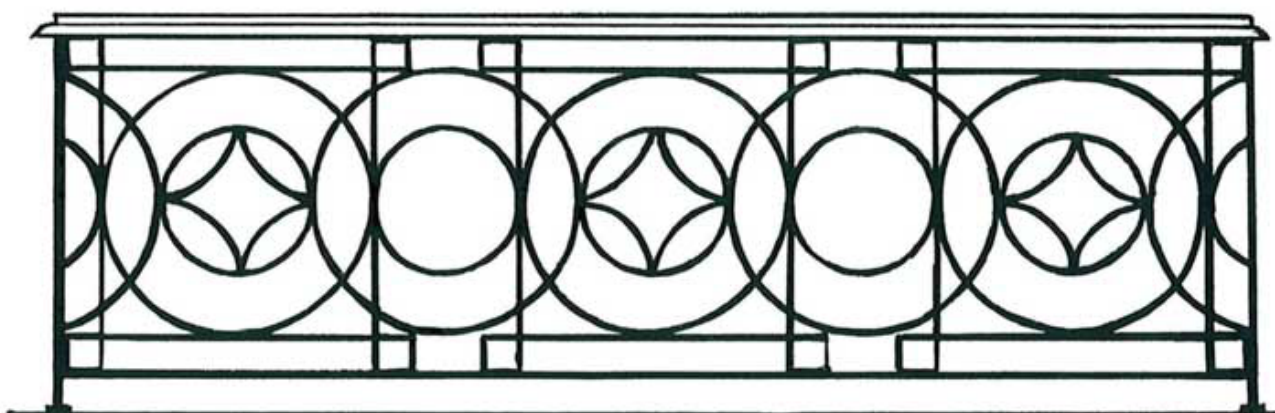

2/50

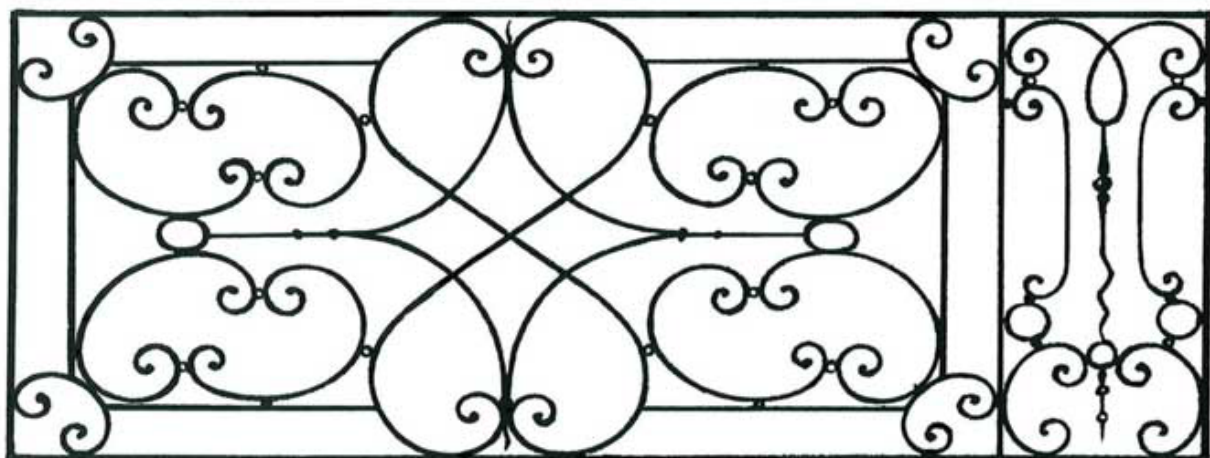

3/50



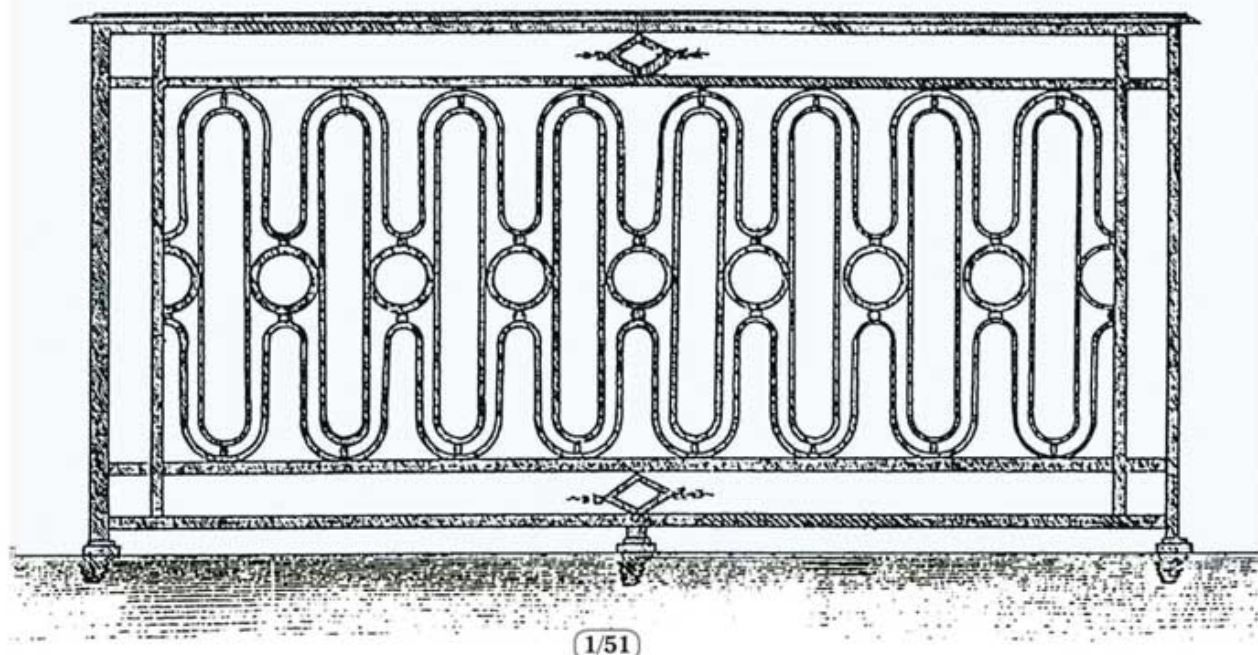

1/51

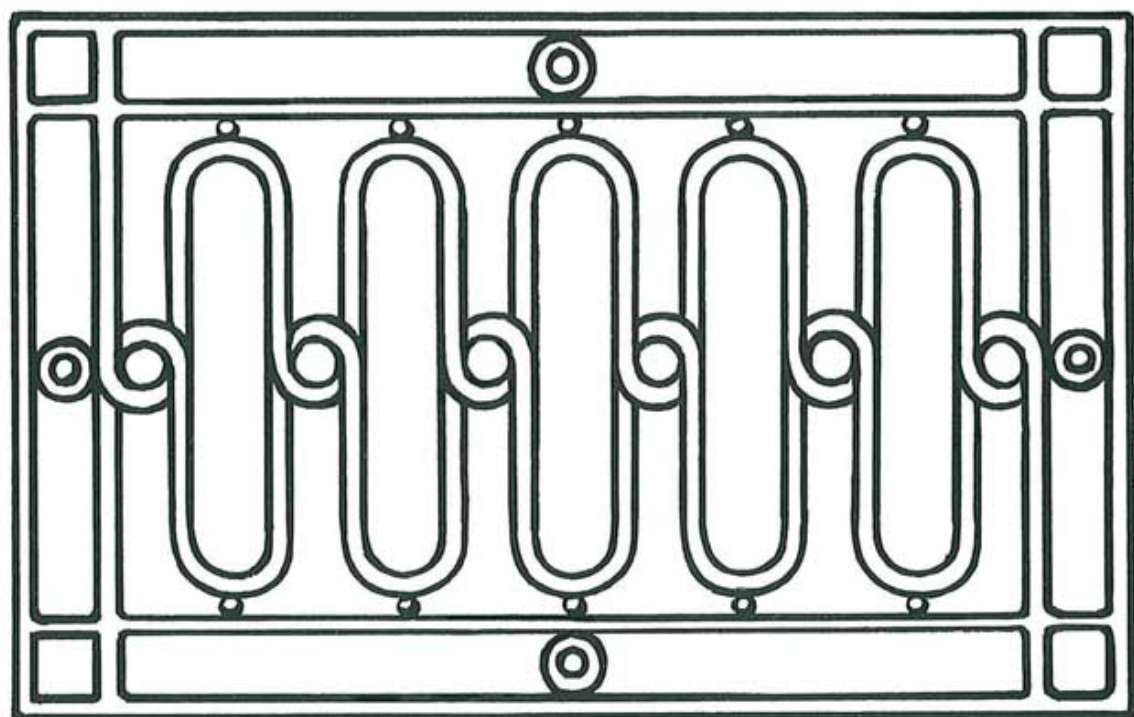

2/51

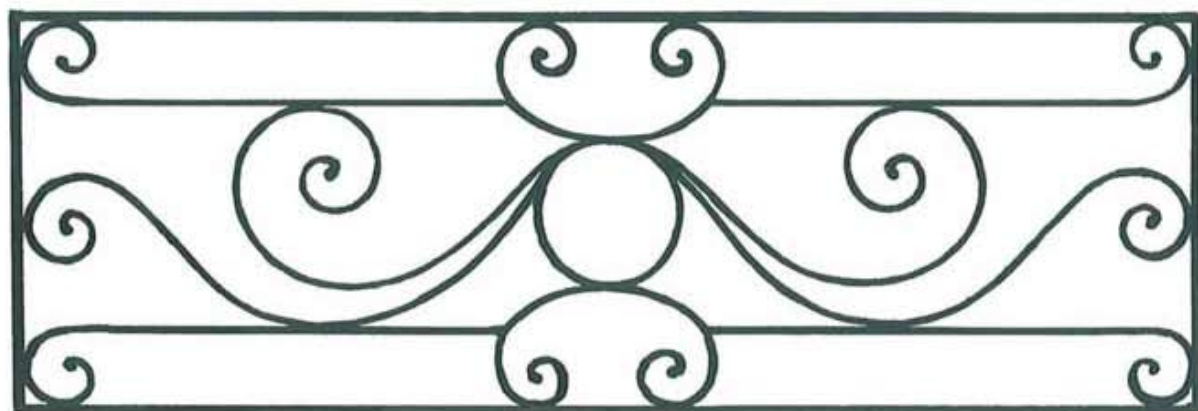

1/52

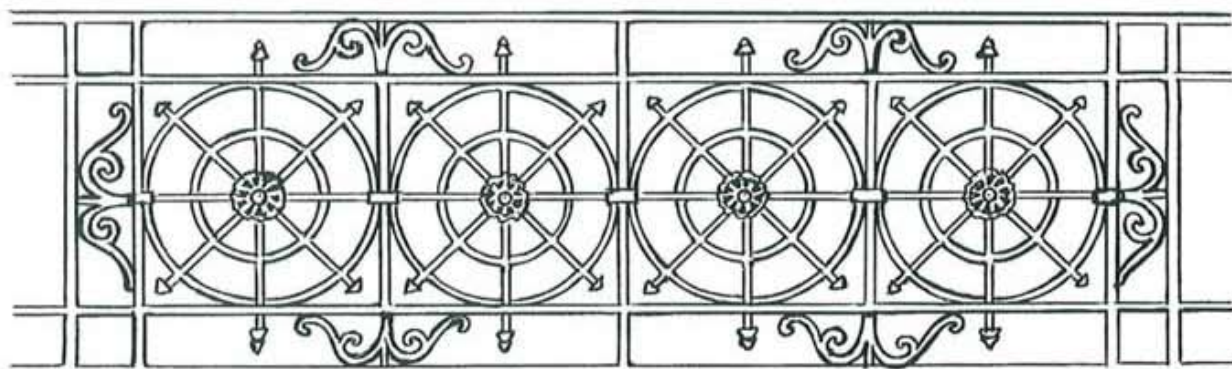

2/52

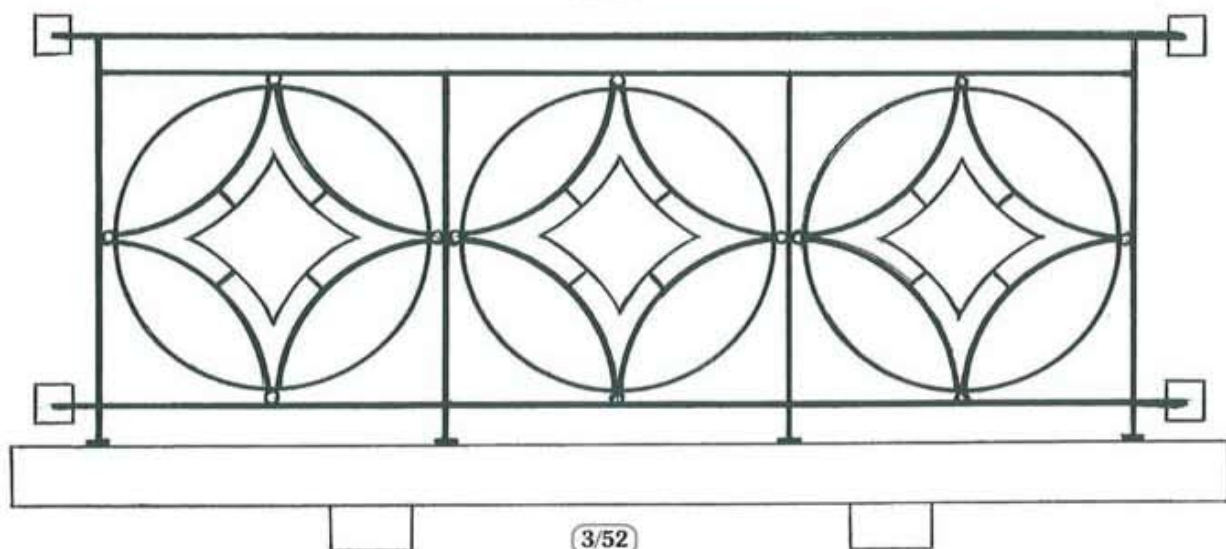

3/52



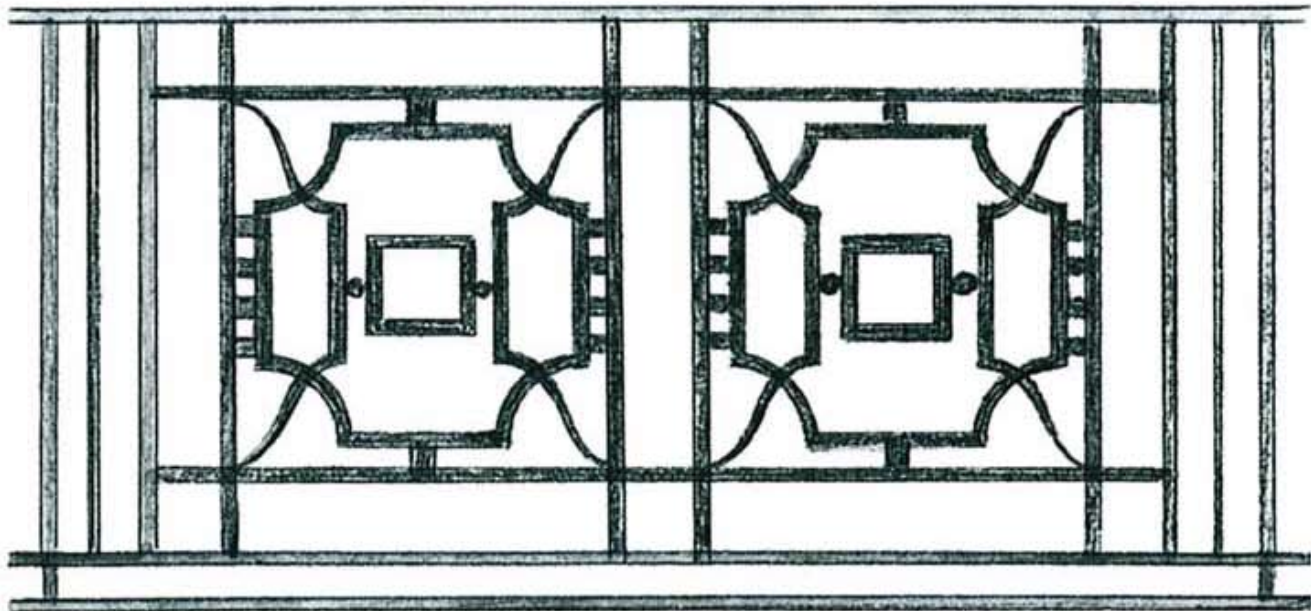

1/53



2/53

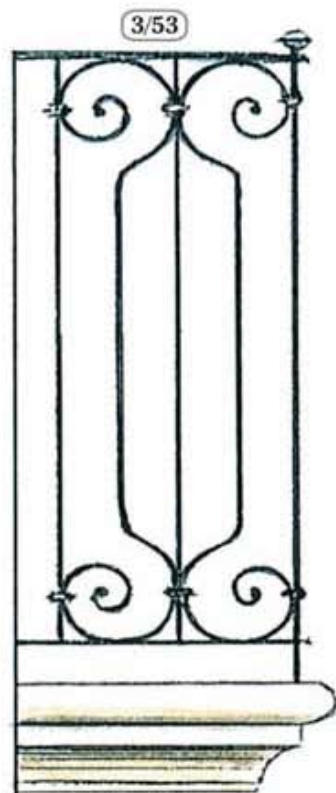

3/53



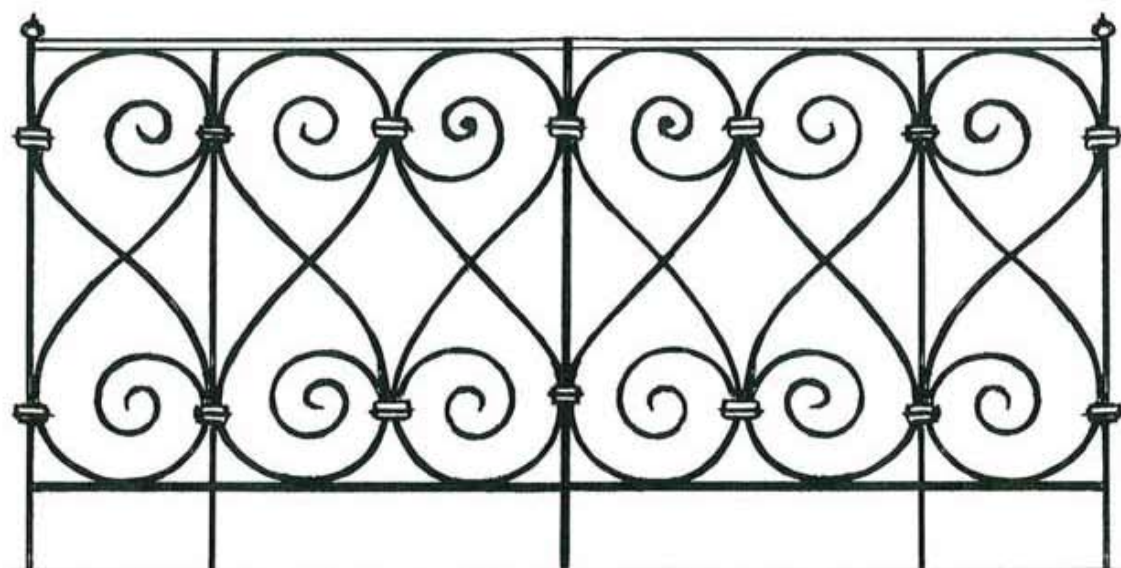



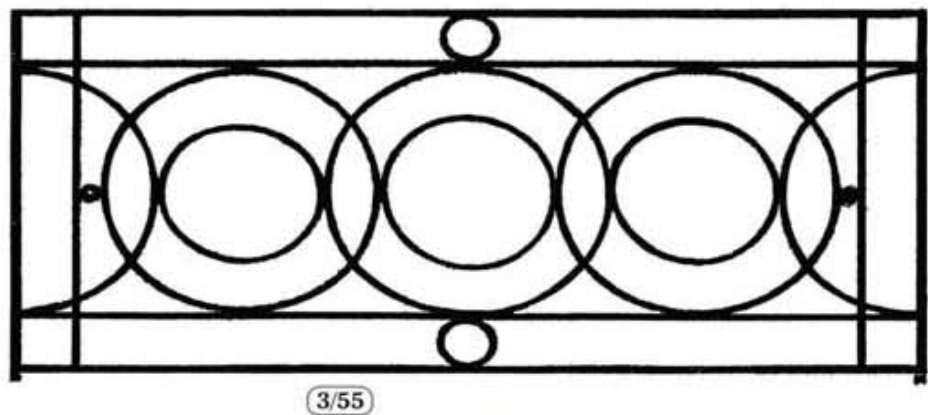
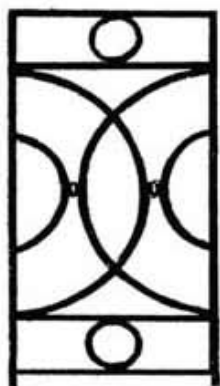
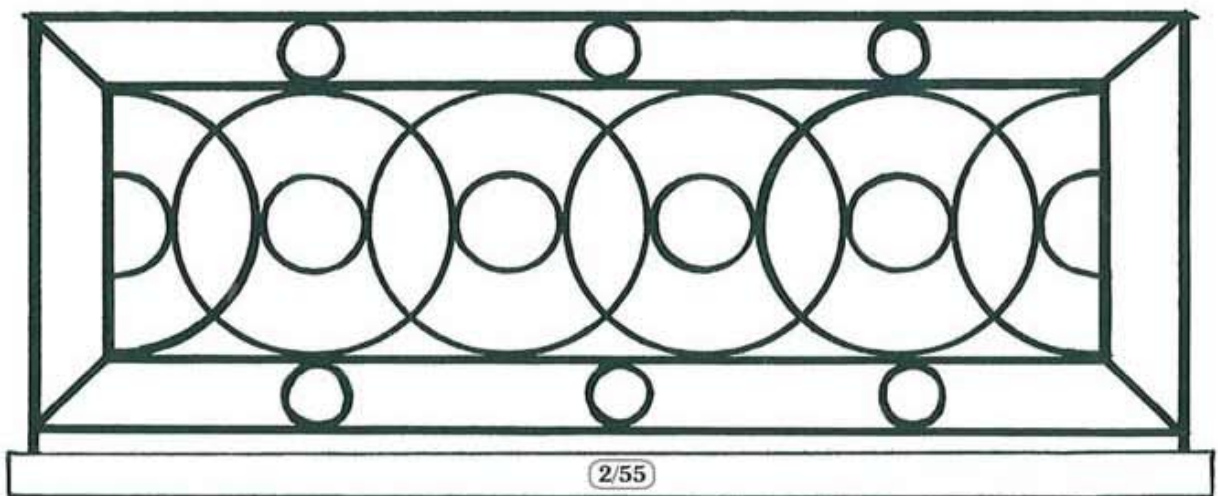
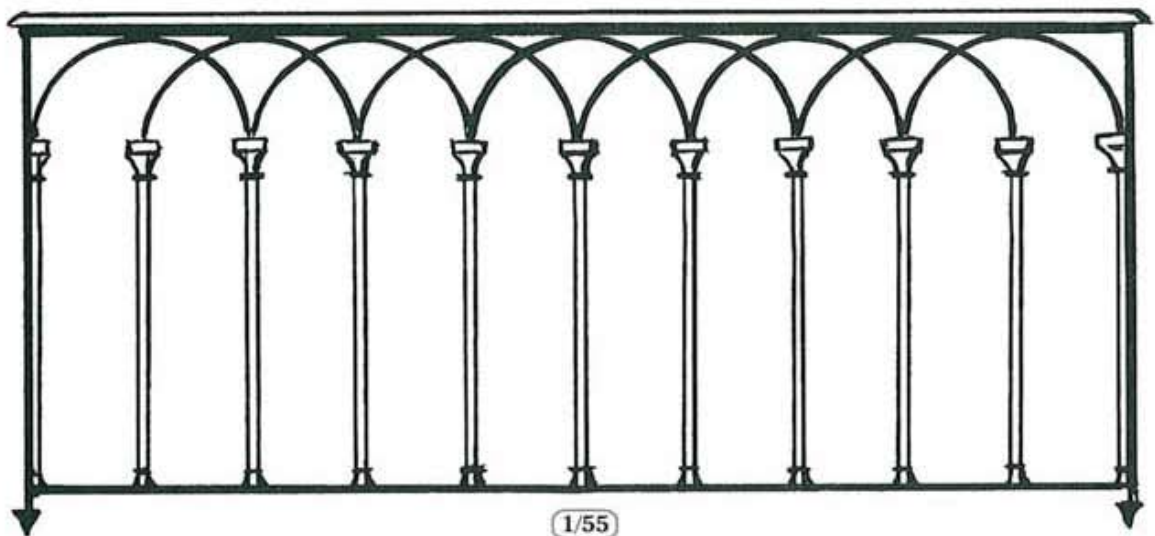

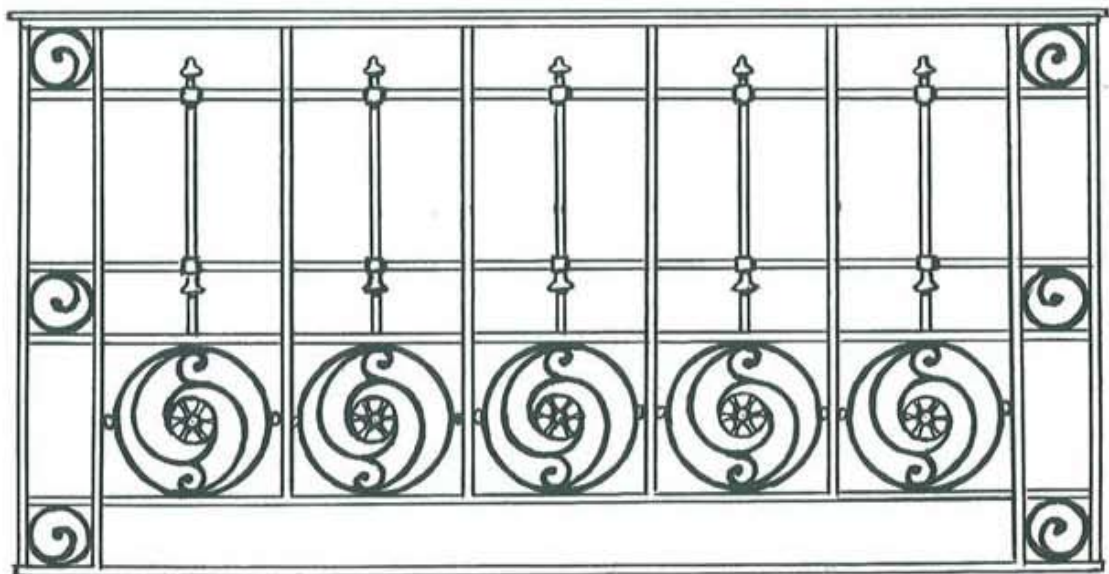

1/56

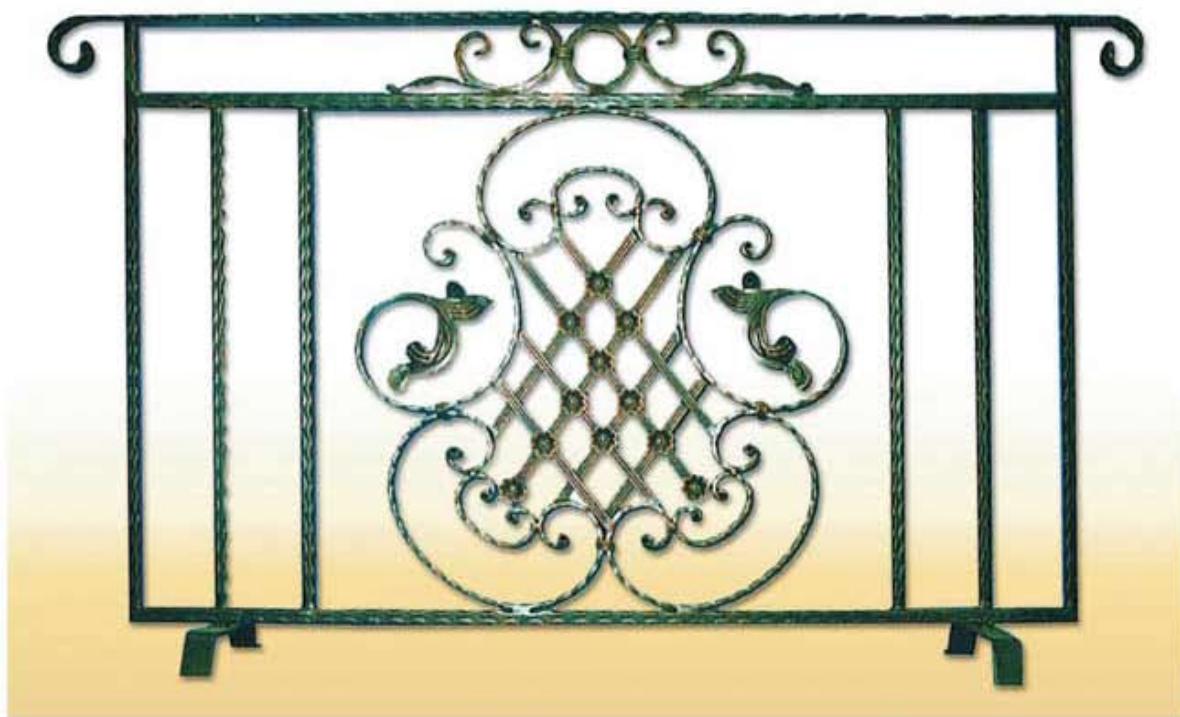

2/56





1/57



1/58







**ΔΟΥΚΑΣ®**  
ΣΥΣΤΗΜΑΤΑ ΑΛΟΥΜΙΝΙΟΥ - ΜΗΧΑΝΗΜΑΤΑ

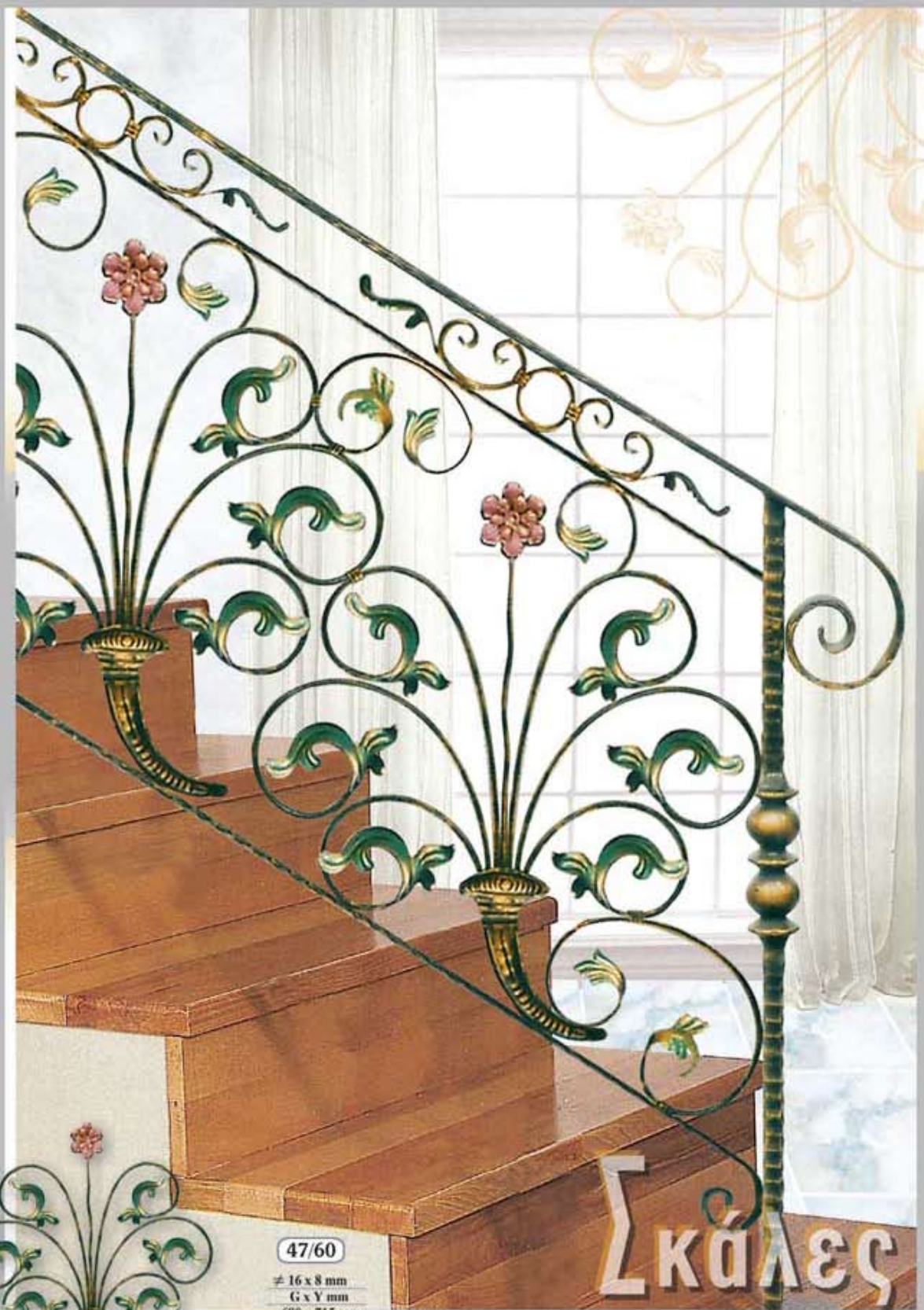

47/60

± 16 x 8 mm  
G x Y mm  
680 x 715 mm

ΣΚΑΛΕΣ





48/61

∅ 12 mm  
G x Y mm  
170 x 800 mm



ΣΚΑΛΕΣ



49/61

∅ 14-16 mm  
G x Y mm  
110 x 800 mm





**50/62**

Ø 14 mm  
G x Y mm  
165 x 800 mm



**51/62**

Ø 14 mm  
G x Y mm  
80 x 1000 mm

**ΣΚΑΛΕΣ**





**52/63**  
 Ø 14 mm  
 G x Y mm  
 215 x 1000 mm



**ΣΑΥΚΟΣ**



**53/63**  
 Ø 14/16 mm  
 G x Y mm  
 155 x 1000 mm

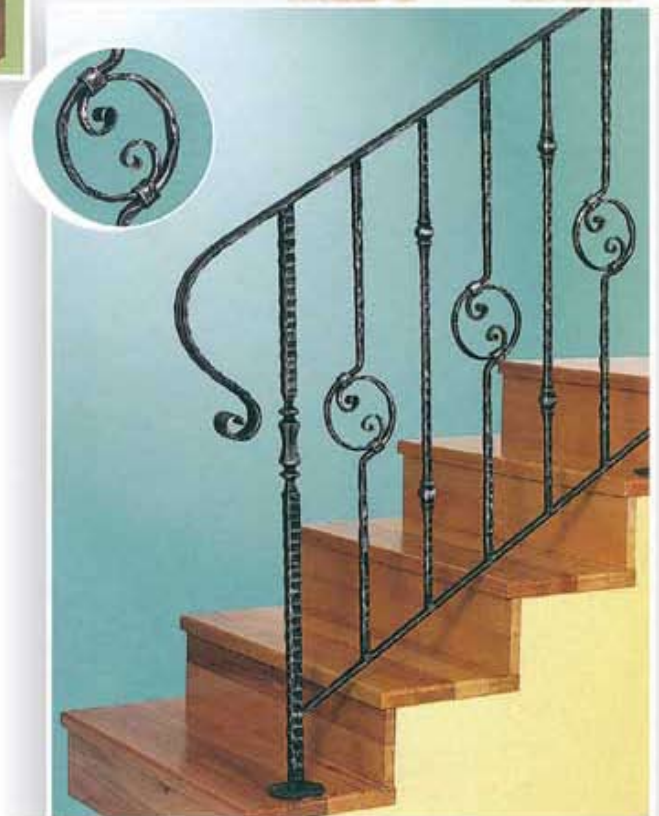



**54/64**

Ø 14 mm  
 G x Y mm  
 165 x 800 mm

**ΣΚΑΛΕΣ**



**55/64**

∇ 12 mm  
 G x Y mm  
 210 x 800 mm

**56/64**

≠ 12 x 6 mm  
 G x Y mm  
 520 x 80 mm







57/65

∅ 16 mm  
G x Y mm  
155 x 1000 mm

58/65

∅ 16 mm  
G x Y mm  
140 x 1000 mm



59/65

∅ 16 x 8 mm  
G x Y mm  
120 x 800 mm





**60/66**

Ø 12/14/16 mm

∇ 12/14/16 mm

G x Y mm

310 x 900 mm



**ΣΚΑΛΕΣ**



**61/66**

∇ 14/16 mm

G x Y mm

160 x 800 mm





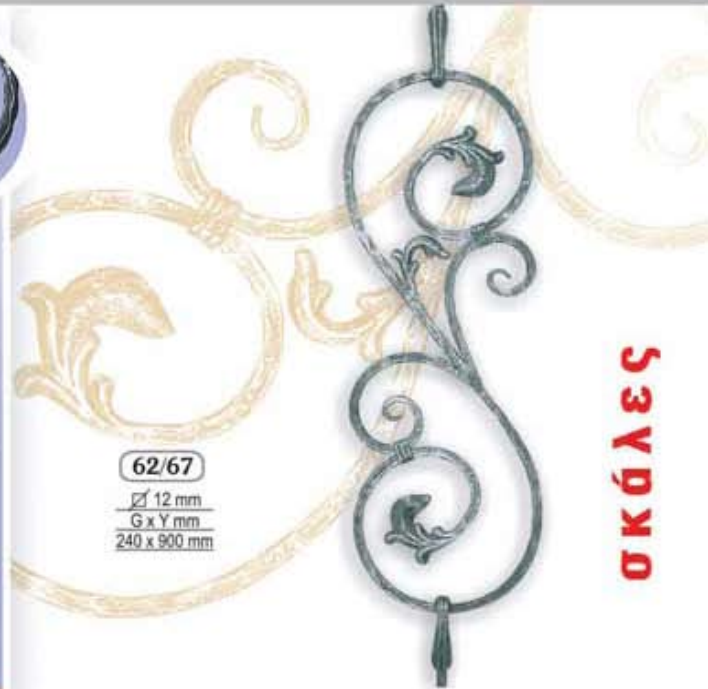

62/67

∅ 12 mm  
G x Y mm  
240 x 900 mm

σκάλες

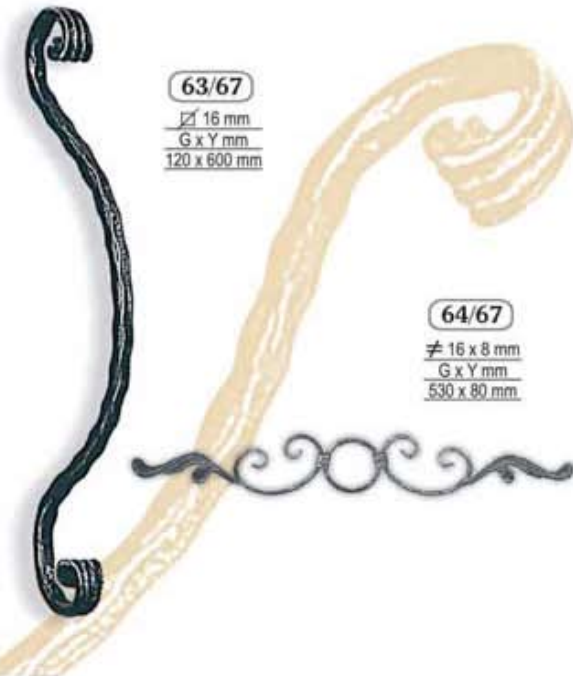

63/67

∅ 16 mm  
G x Y mm  
120 x 600 mm

64/67

∅ 16 x 8 mm  
G x Y mm  
530 x 80 mm





65/68

∅ 12 mm  
G x Y mm  
190 x 800 mm



σκάλες



66/68

∅ 14 x 6 mm  
G x Y mm  
240 x 800 mm







67/69

∅ 12 mm  
Y mm  
800 mm



68/69

∅ 12 mm  
Y mm  
800 mm



ΣΑΓΚΑΛΕΣ



69/69

∅ 12 mm  
Y mm  
800 mm





**71/70**

Ø 14/16/18/20 mm  
 Y mm  
 800 mm

**70/70**

Ø 14/16/18/20 mm  
 Y mm  
 800 mm

**σκάλες**



**72/70**

Ø 12/14/16 mm  
 Y mm  
 800 mm

απλό & σφουρήλατο

**73/70**

Ø 12/14/16 mm  
 Y mm  
 800 mm

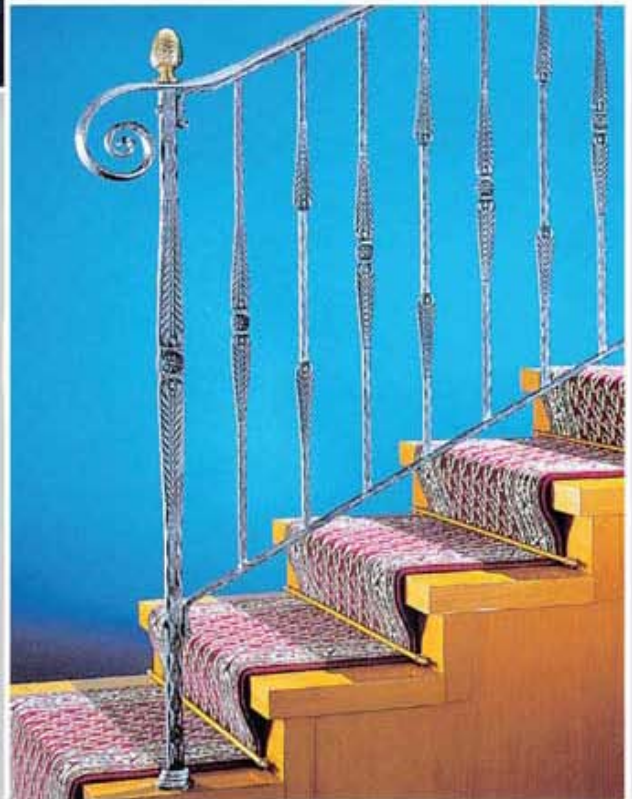









478/72



479/72





483/73





**ΔΟΥΚΑΣ®**  
ΣΥΣΤΗΜΑΤΑ ΑΛΟΥΜΙΝΙΟΥ - ΜΕΤΑΛΛΑ



484/74





485/75



121/75



490/75



492/76



493/76





**494/77**

∅ 25 mm  
5.720 kg  
1200 mm



**495/77**

∅ 12 mm  
1.190 kg  
G x Y mm  
25x150x800

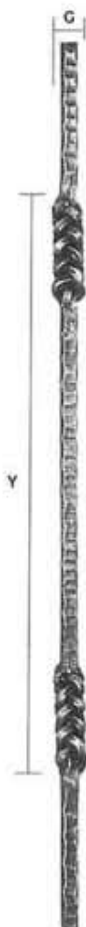

**496/77**

∅ 12 mm  
1.270 kg  
G x Y mm  
25x560x800



**497/77**



**498/77**





508/78





509/79





511/80





513/81

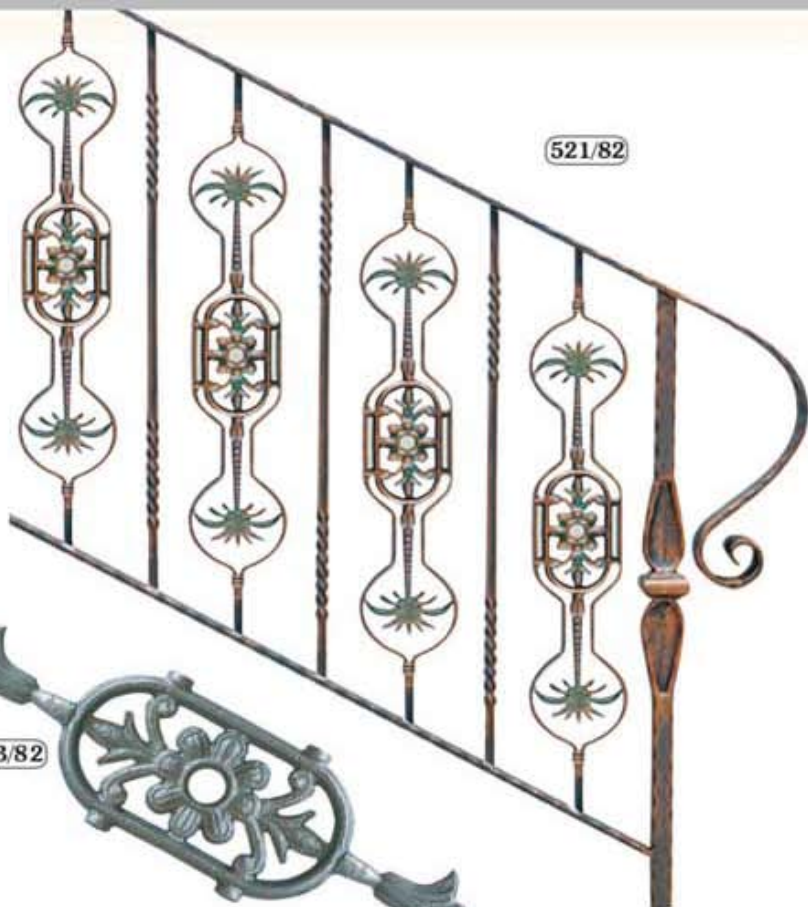

521/82

521 B/82

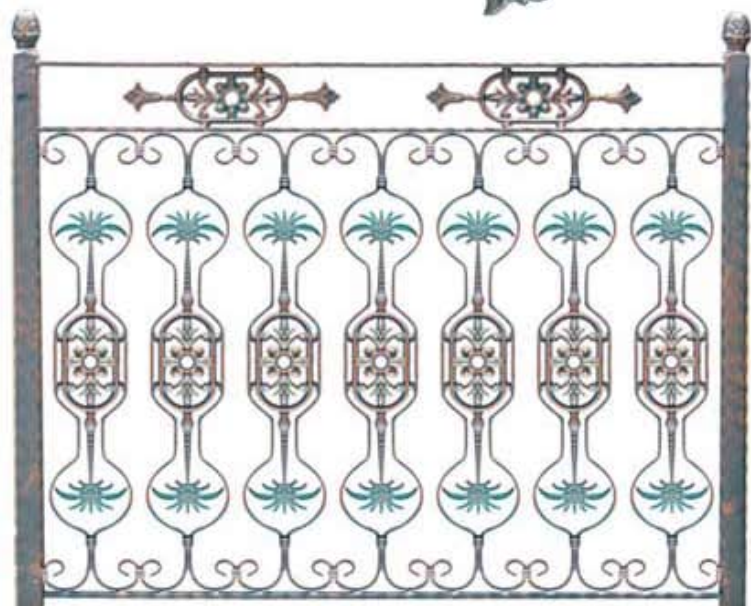

522/82



523/82

∅ 12 mm

2.490 kg

G 130 x Y 800 mm



**529/83**

∅ 12 mm  
1,470 kg  
G x Y mm  
120 x 310 x 1000



**530/83**

∅ 12 mm  
1,300 kg  
G x Y mm  
50 x 230 x 1000



**531/83**

∅ 12 mm  
1,390 kg  
G x Y mm  
85 x 400 x 1000



**532/83**

∅ 12 mm  
1,390 kg  
G x Y mm  
85 x 340 x 1000

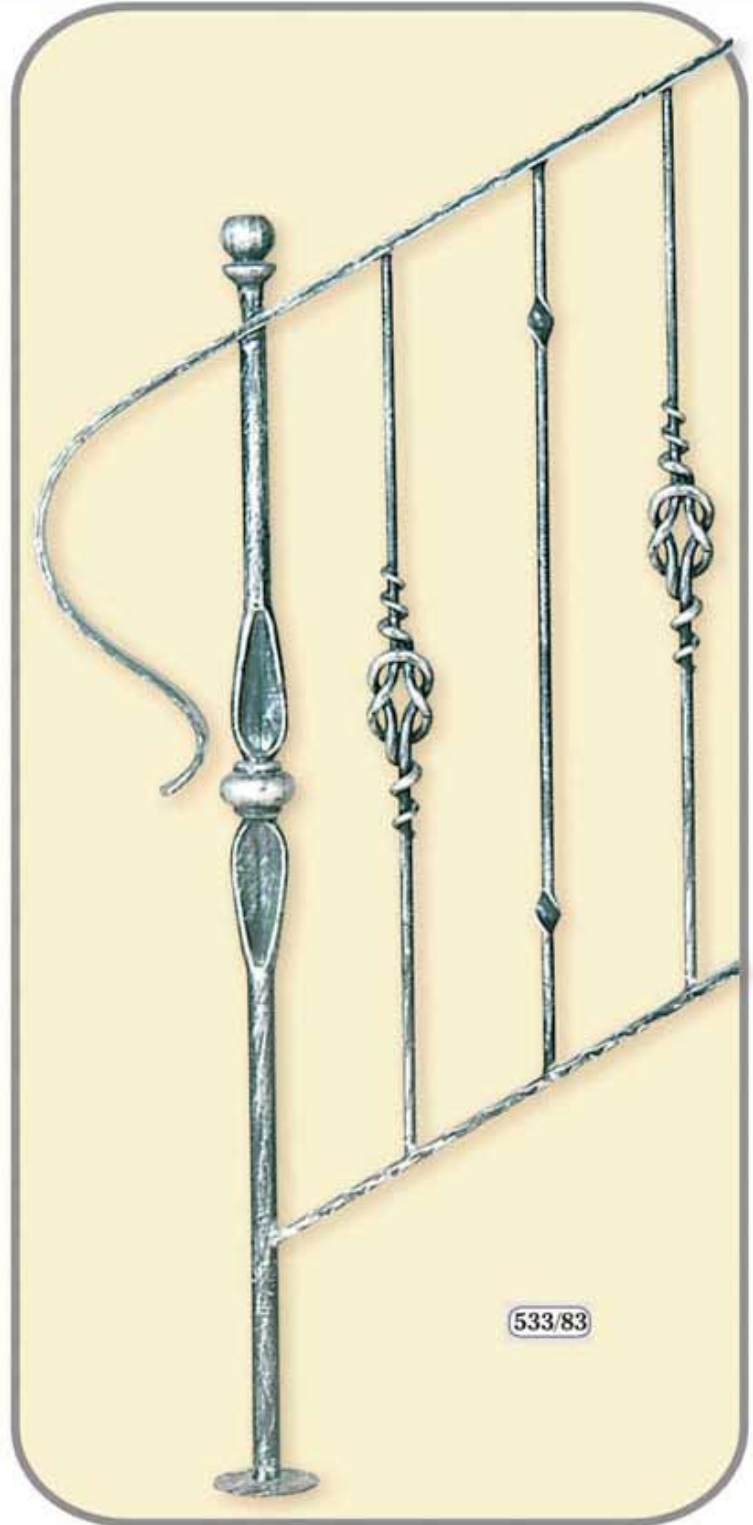

**533/83**



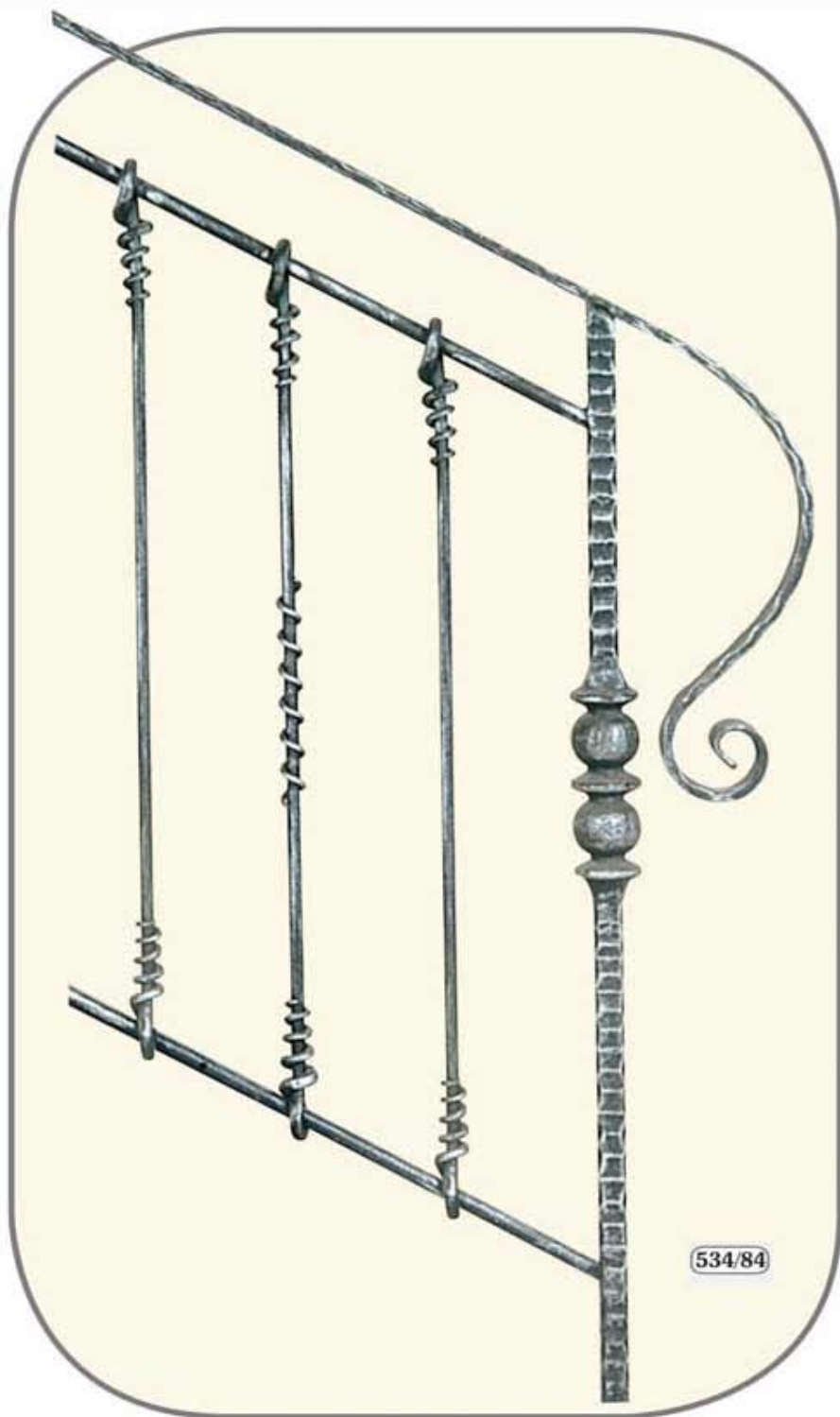

534/84



535/84

∅ 12 mm  
1,180 kg  
G 50 x Y 800 mm

536/84

∅ 12 mm  
1,120 kg  
G 50 x Y 800 mm





537/85

∅ 12 mm

G x Y mm

390 x 800 mm

538/85

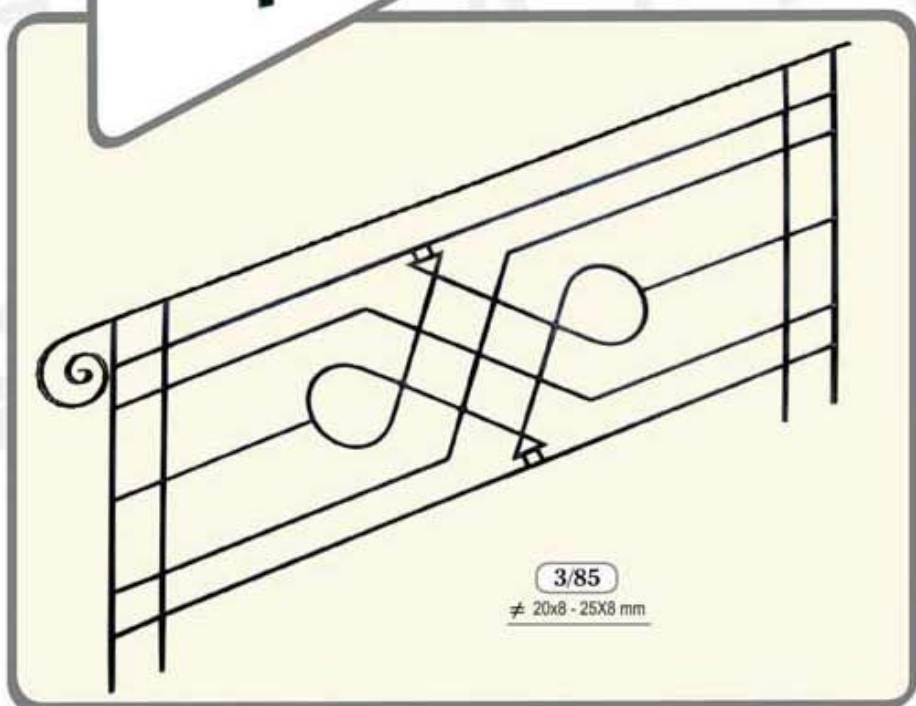
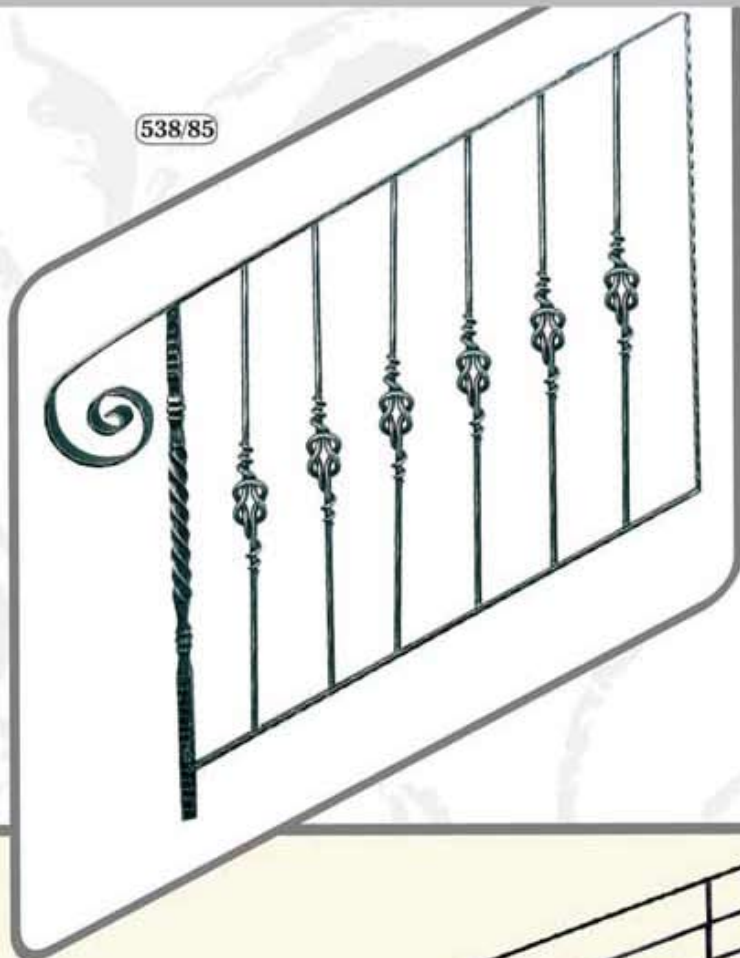

3/85

≠ 20x8 - 25x8 mm









1/87  
 Ø 12/14 mm

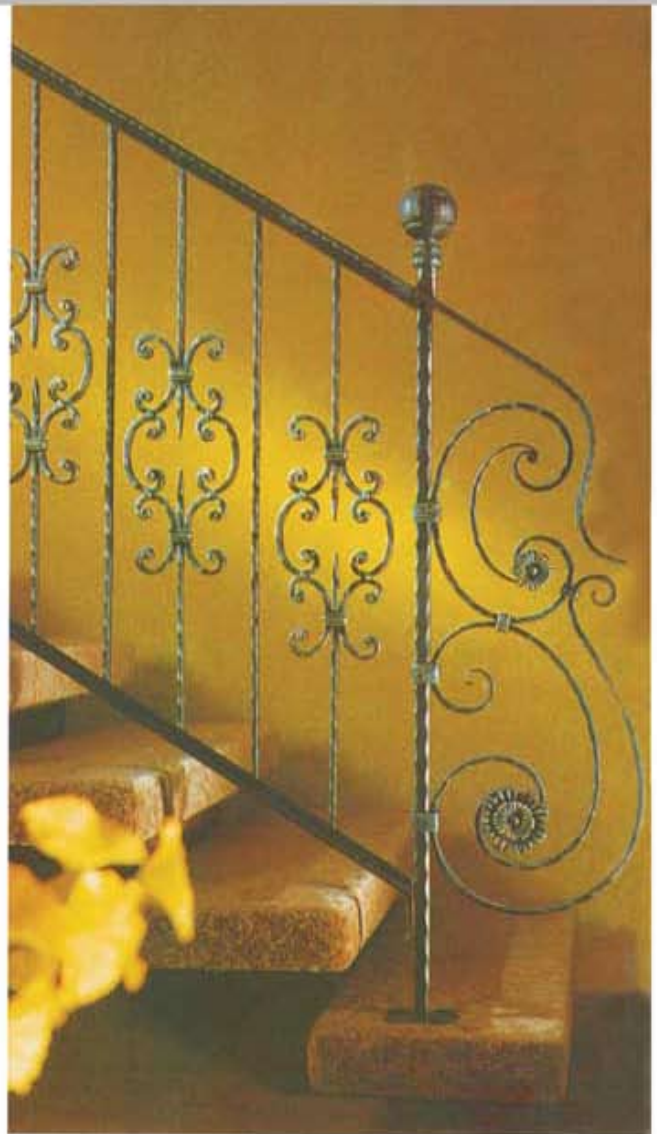

2/87



3/87





60/88

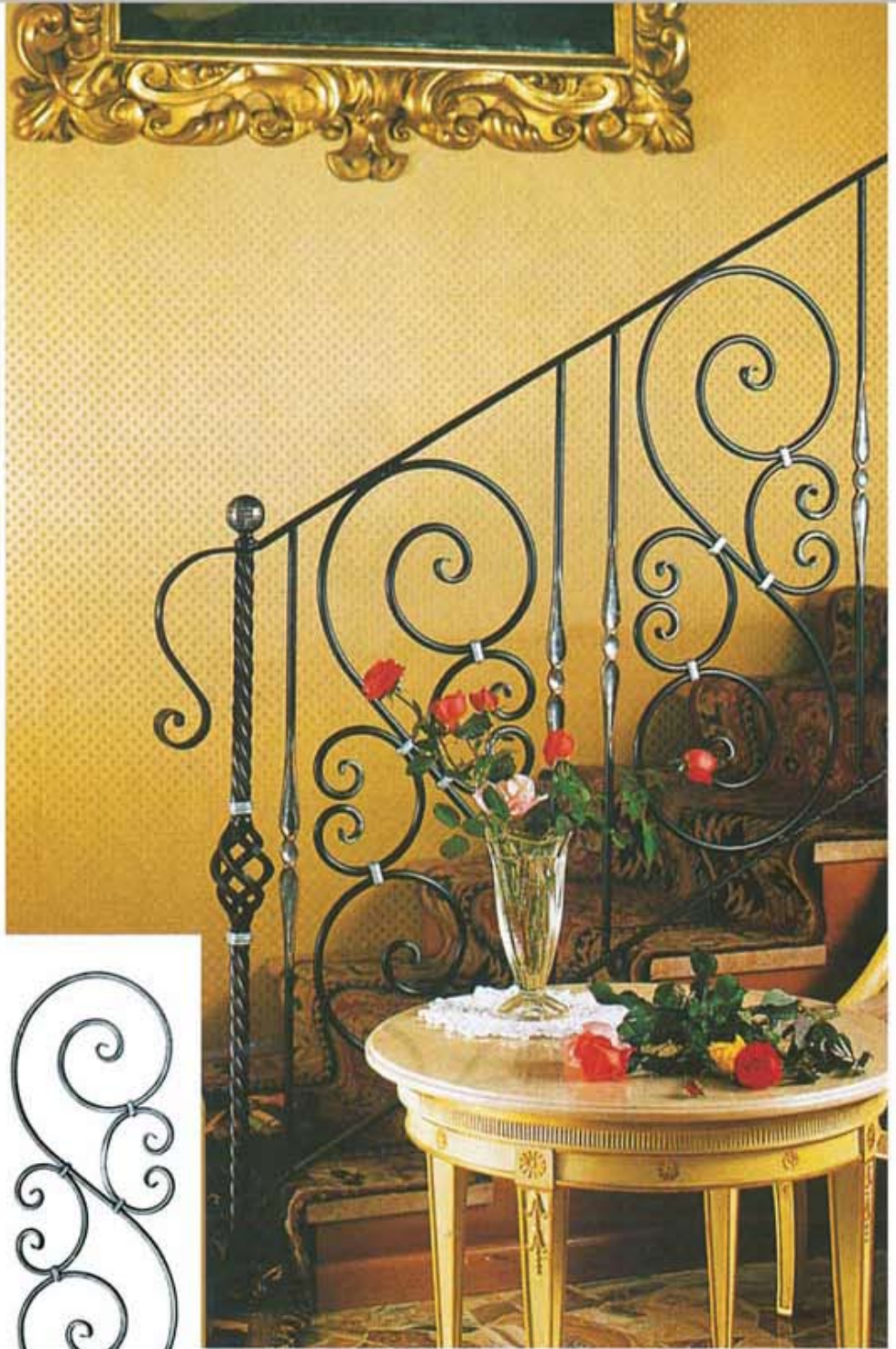





1/89



1/90

2/90

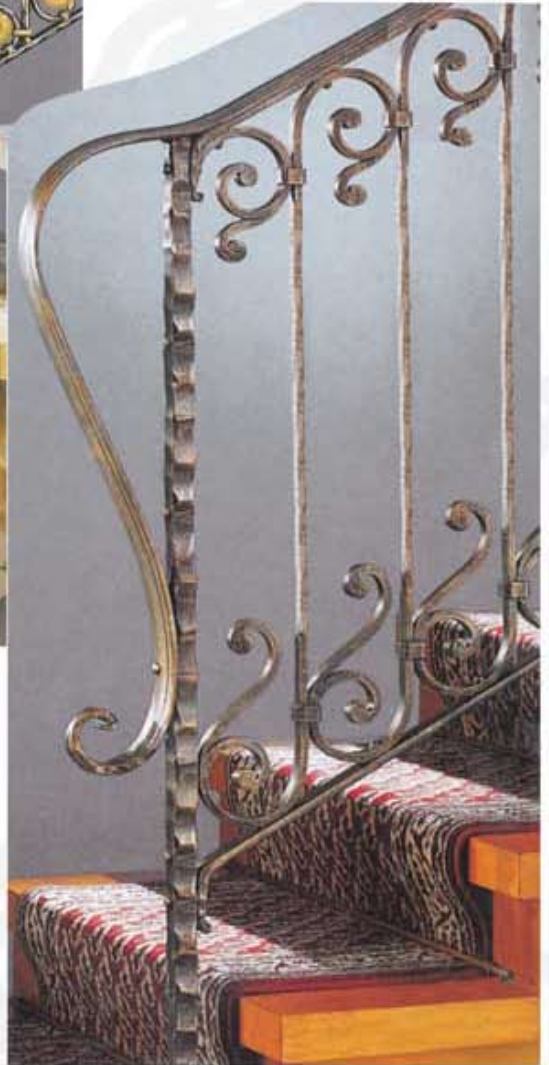



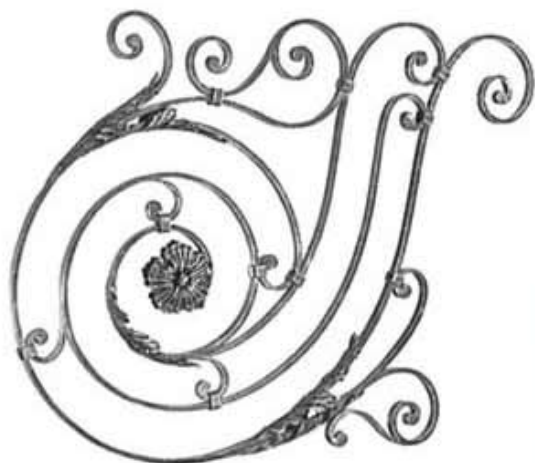

1/91

≠ 14x8 - 16x8 mm



2/91

≠ 14x8 - 16x8 mm





3/92





1/93



2/93



3/93





1/94







1/95



2/95





1/96





1/97





1/98





1/99



2/99

∅ 8/10 mm



3/99

∅ 12/14 mm



4/99



530/99

∅ 12/14 mm





1/100



2/100



1/101



2/101





1/102

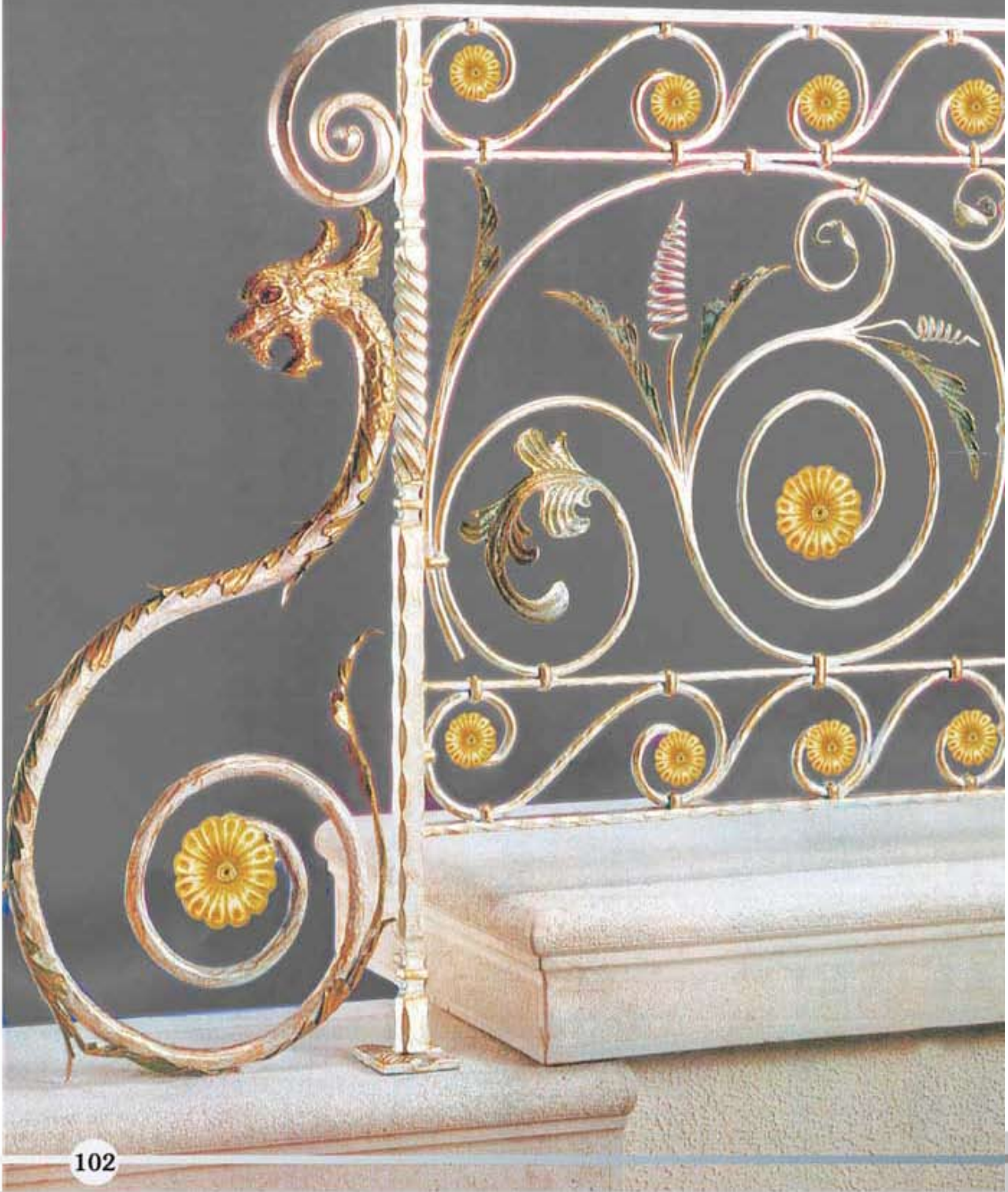





1/103



2/103



3/103





1/104

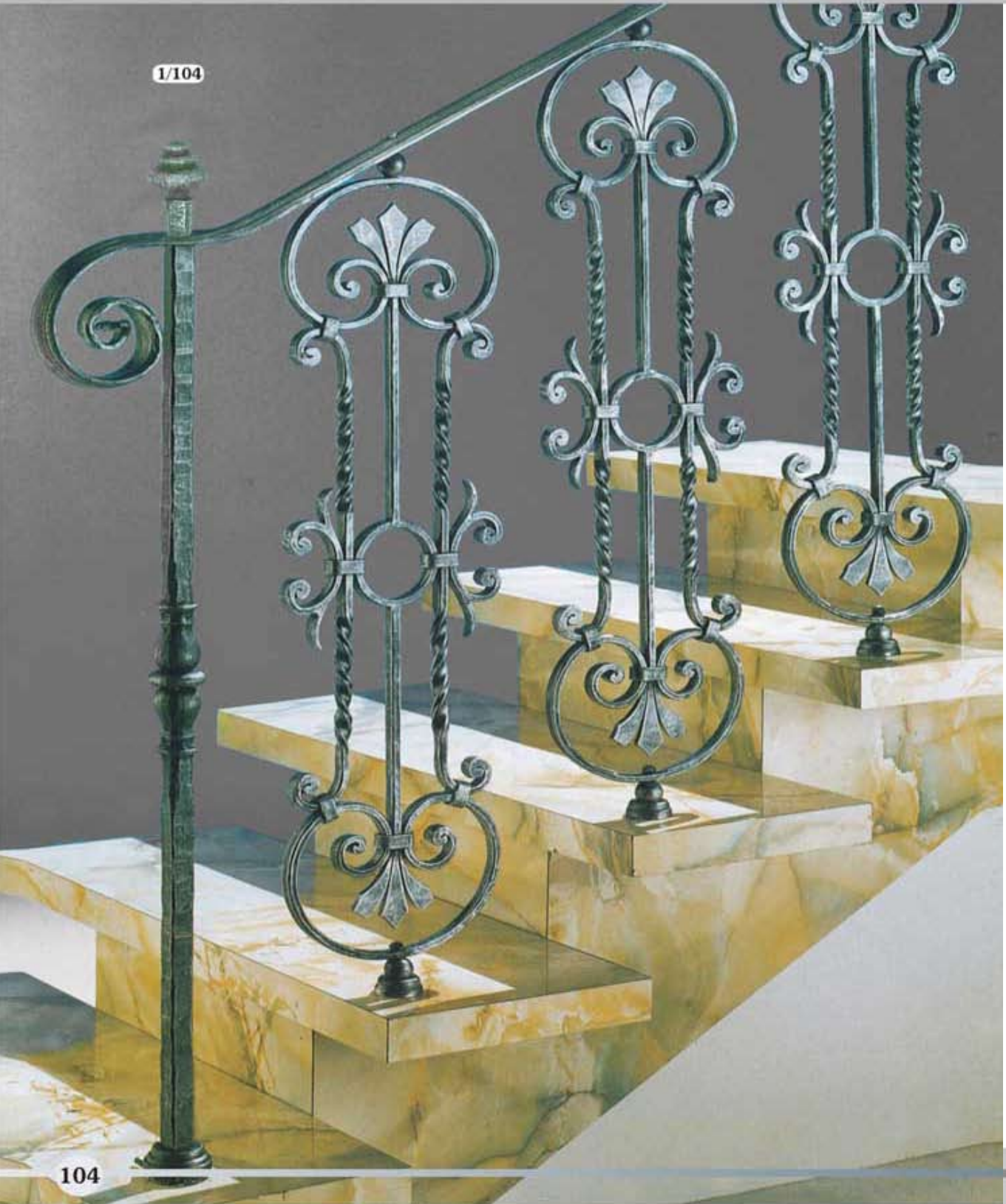





1/105



2/105





1/106

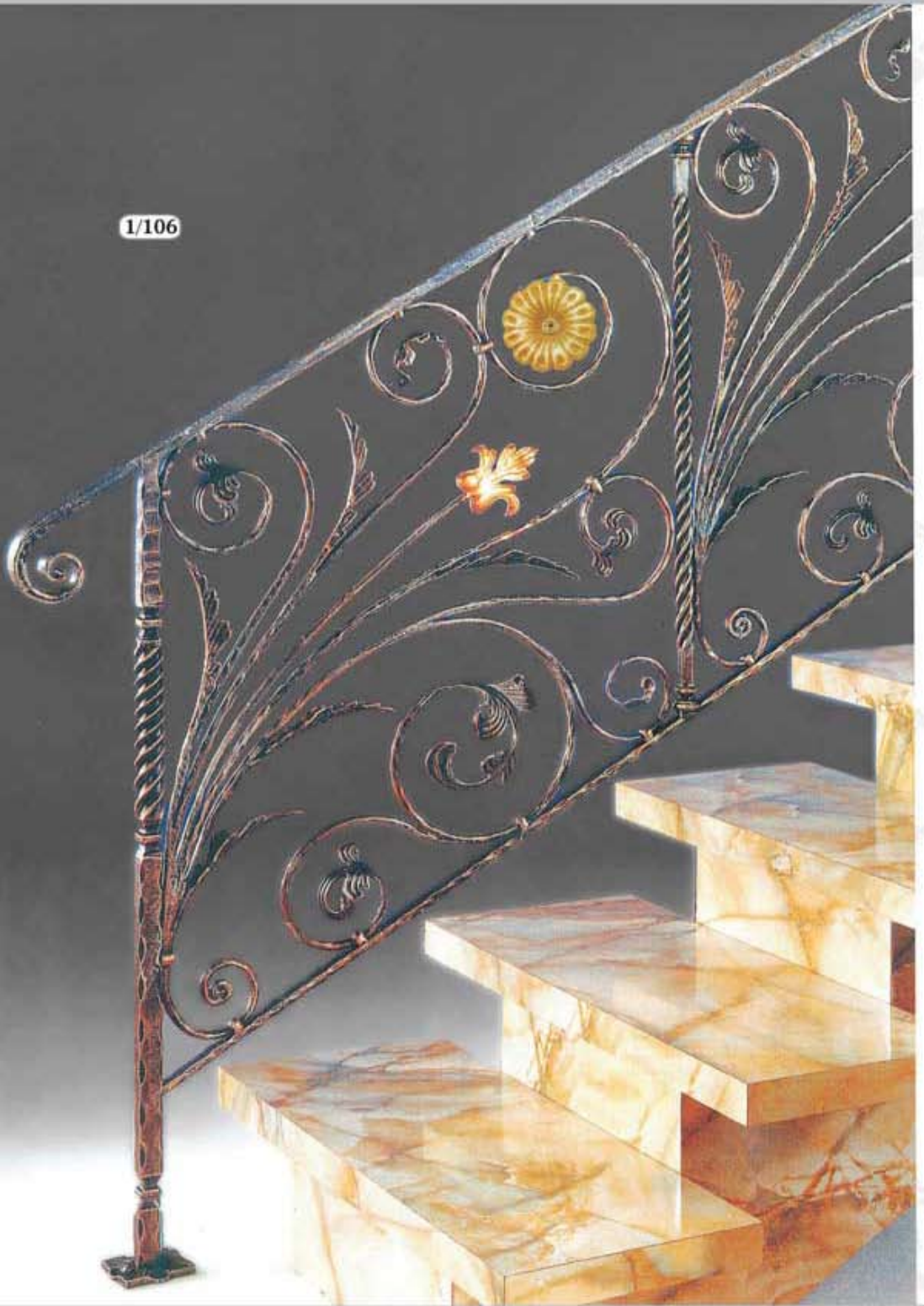





1/107



2/107



1/108





Πόρτες

74/109



# Πόρτες

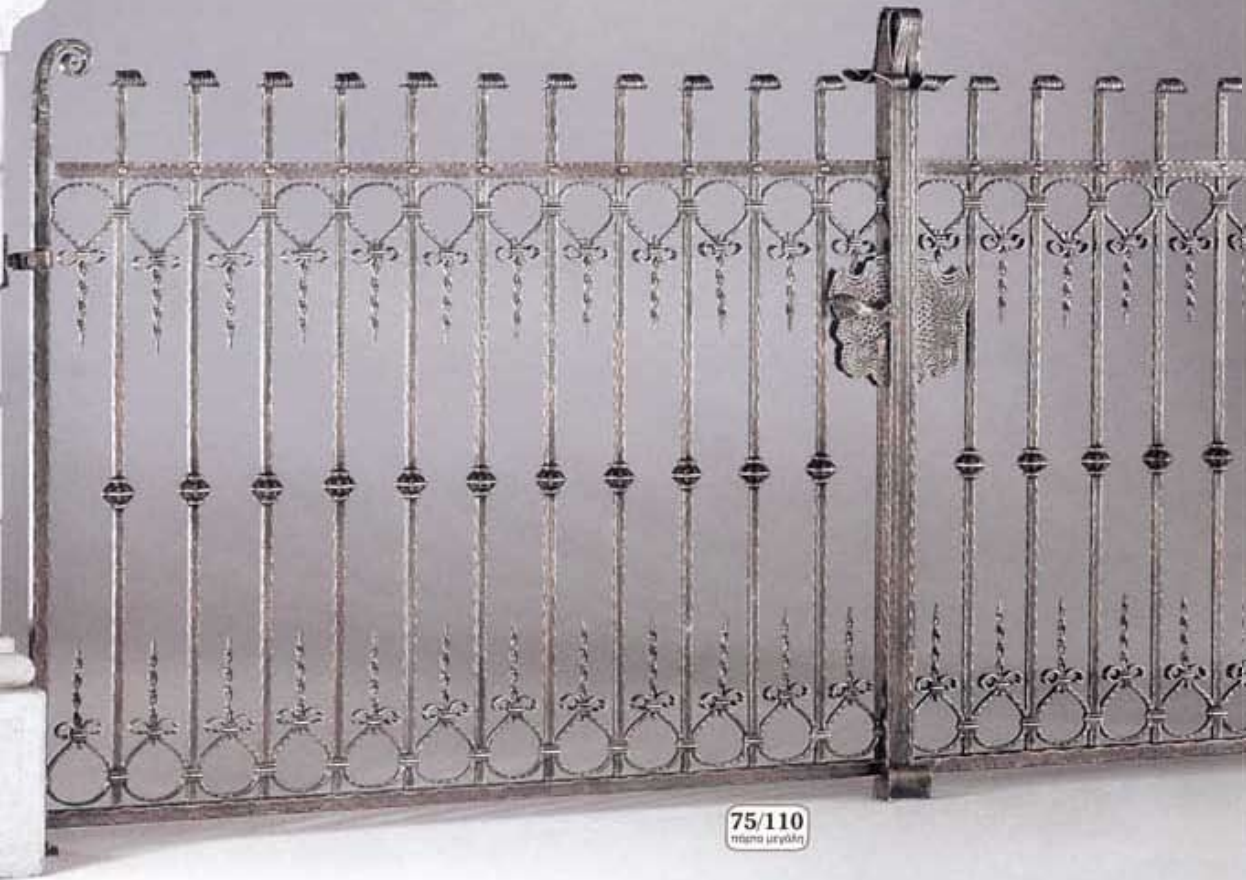

75/110  
mm πλάτος





75/111  
από 1200€

 **ΔΟΥΚΑΣ®**  
ΣΥΣΤΗΜΑΤΑ ΑΛΟΥΜΙΝΙΟΥ - ΜΗΧΑΝΗΜΑΤΑ



Πόρτες

76/112





77/113



78/113



79/113

ΠÓΡΤΕΣ







80/114



81/114

**ΠΟΡΤΕΣ**





82/115



83/115





Πόρτες



84/116



85/116



86/116

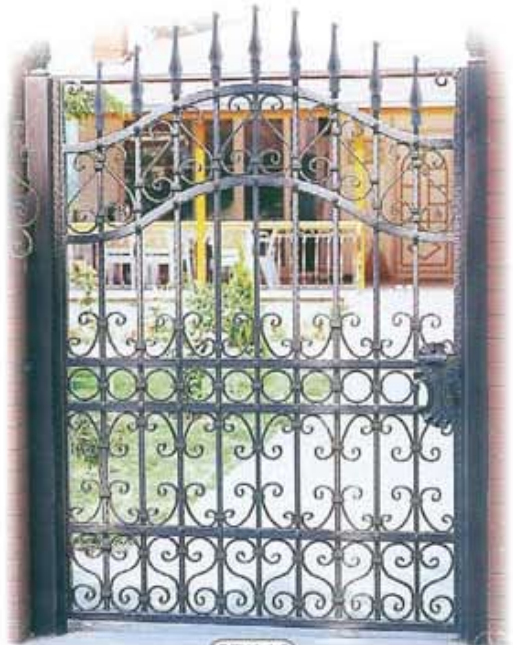

87/116





471/117

117



**ΔΟΥΚΑΣ**  
ΣΥΣΤΗΜΑΤΑ ΑΣΦΑΛΕΙΑΣ - ΜΟΝΩΣΕΙΣ







474/119







480/120

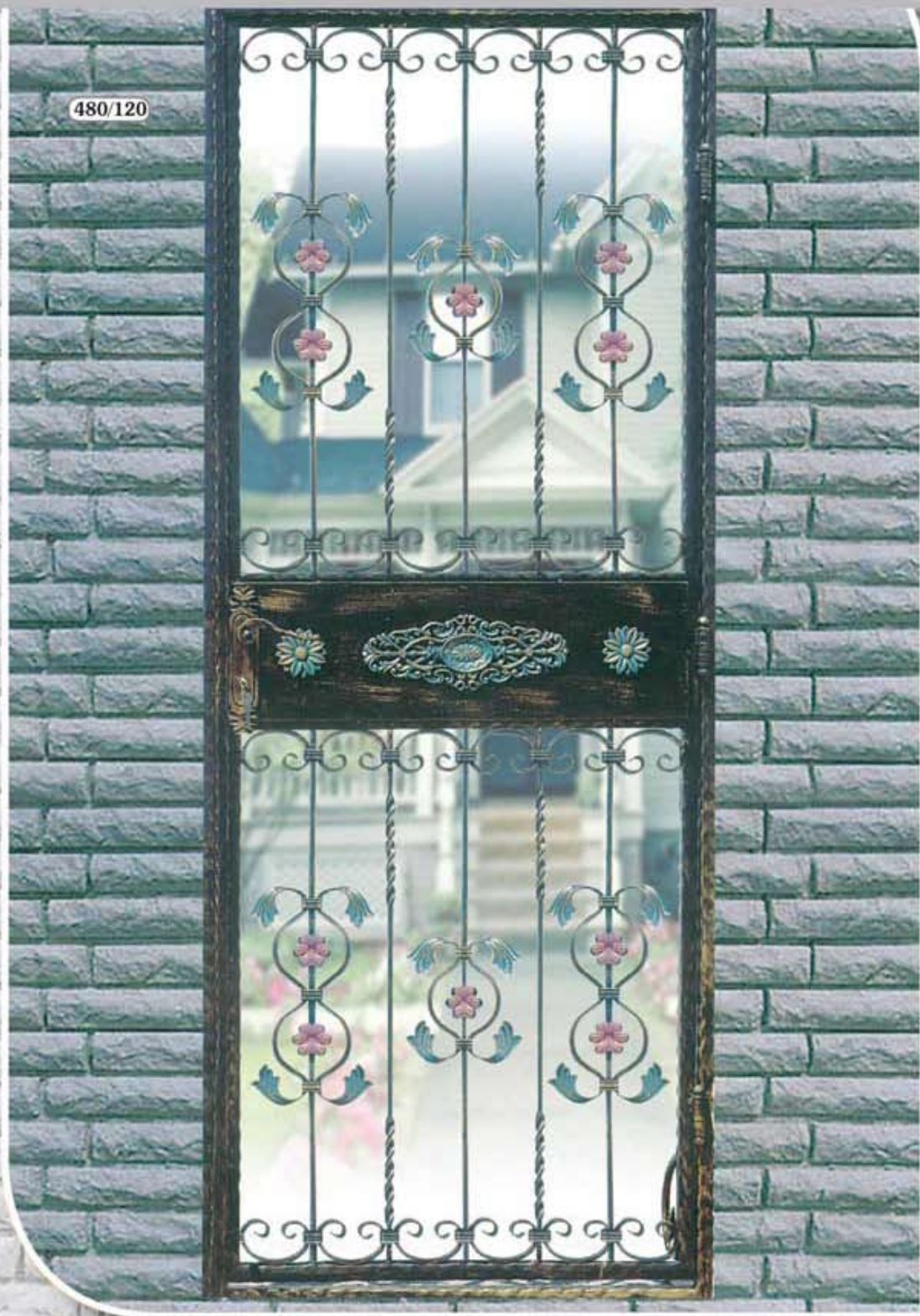













524/123 ΚΩΔ. 24155

∅ 12 x 6 mm  
 ∅ 14 x 6 mm  
 G 160 x Y 800 mm

525/123



**DOUKAS**  
 ΣΥΣΤΗΜΑΤΑ ΑΣΦΑΛΙΣΤΙΚΩΝ - ΜΗΧΑΝΙΣΜΑΤΑ





597/124

598/124







1/125



2/125



4/125



3/125



5/125





**551/126**

**ΚΩΔ. 29233**

∅ 12 mm

5.300 kg

G x Y mm

400 x 800 mm

**551A/126 ΚΩΔ. 29234**

∅ 12 mm

5.300 kg

G x Y mm

400 x 800 mm



**552/126**



**553/126**



**554/126 ΚΩΔ. 29235**

∅ 16 x 8 mm

10.980 kg

G x Y mm

800 x 800 mm





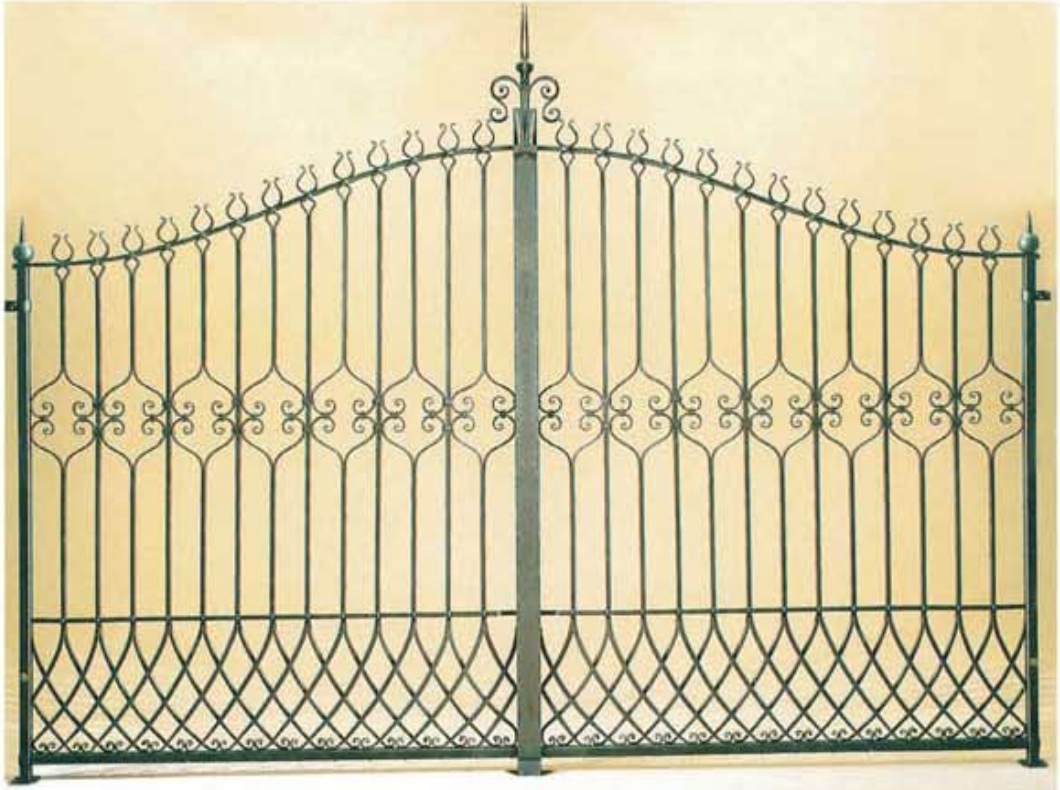

1/128

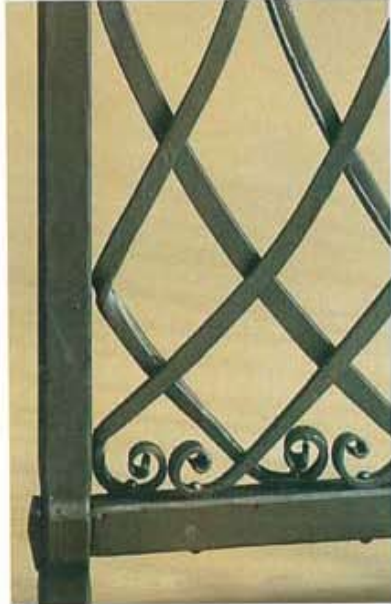



1/129



2/129





1/130



2/130



3/130





1/131



2/131



1/132





1/133







**ΔΟΥΚΑΣ®**  
ΣΥΣΤΗΜΑΤΑ ΑΛΟΥΜΙΝΙΟΥ - ΜΕΤΑΛΛΑ



594/134





1/135





1/136  
πρόσιτο μέγεθος





1/137  
137/01



**DOUKAS®**  
ΣΥΣΤΗΜΑΤΑ ΑΣΦΑΛΙΣΗΣ - ΜΟΝΩΣΕΙΣ

137







1/139  
1/139



1/140  
πύλη μεγάλη





1/141  
141/1



**DOUKAS**  
ΣΥΣΤΗΜΑΤΑ ΑΣΦΑΛΕΙΑΣ - ΚΑΤΑΣΤΑΣΕΩΣ

141



1/142  
ανά metro μήκους





1/143  
100x100 (cm)





**1/144**  
Μέγεθος μεγάλου





1/145  
ΠΡΩΤΟ ΣΕΡΒΙ



**ΔΟΥΚΑΣ**  
ΣΥΣΤΗΜΑΤΑ ΑΣΦΑΛΕΙΑΣ - ΜΟΝΩΣΕΩΝ



1/146  
ΜΟΝΟ ΜΕΤΡΩΝ



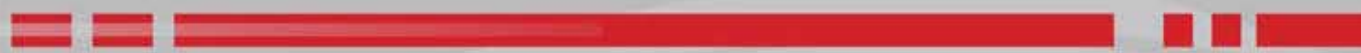

1/147  
ΠΡΩΤΗ ΣΕΡΙΑ



1/148  
πόρτα μεγάλη





1/149  
πύλη μαρμάρου



**DOUKAS®**  
ΣΥΣΤΗΜΑΤΑ ΑΣΦΑΛΙΣΗΣ - ΜΟΝΩΣΕΩΝ



1/150  
κόπια μεγάλου





1/151  
151/1



**DOUKAS**  
ΣΥΣΤΗΜΑΤΑ ΑΣΦΑΛΕΙΑΣ - ΜΟΝΩΣΕΩΝ



1/152  
1/152





1/153  
1/153 (1/153)



**DOUKAS®** 153  
ΣΥΣΤΗΜΑΤΑ ΑΣΦΑΛΙΣΗΣ - ΜΟΝΩΣΕΙΣ



1/154  
μέτρο μεγάλου





1/155  
100cm x 100cm



**DOUKAS**  
ΣΥΣΤΗΜΑΤΑ ΑΣΦΑΛΙΣΗΣ - ΜΗΧΑΝΗΜΑΤΑ

155



1/156  
κόπια μεγάλη





1/157  
mipra (mipra)



**DOUKAS**  
ΣΥΣΤΗΜΑΤΑ ΑΣΦΑΛΙΣΗΣ - ΜΟΝΩΣΕΩΝ

157



# Ασφάλειες Παραθύρων





89/159



90/159



91/159



92/159



ασφάλειες παραθύρων





93/160



94/160



95/160



96/160

**ασφάλειες παραθύρων**





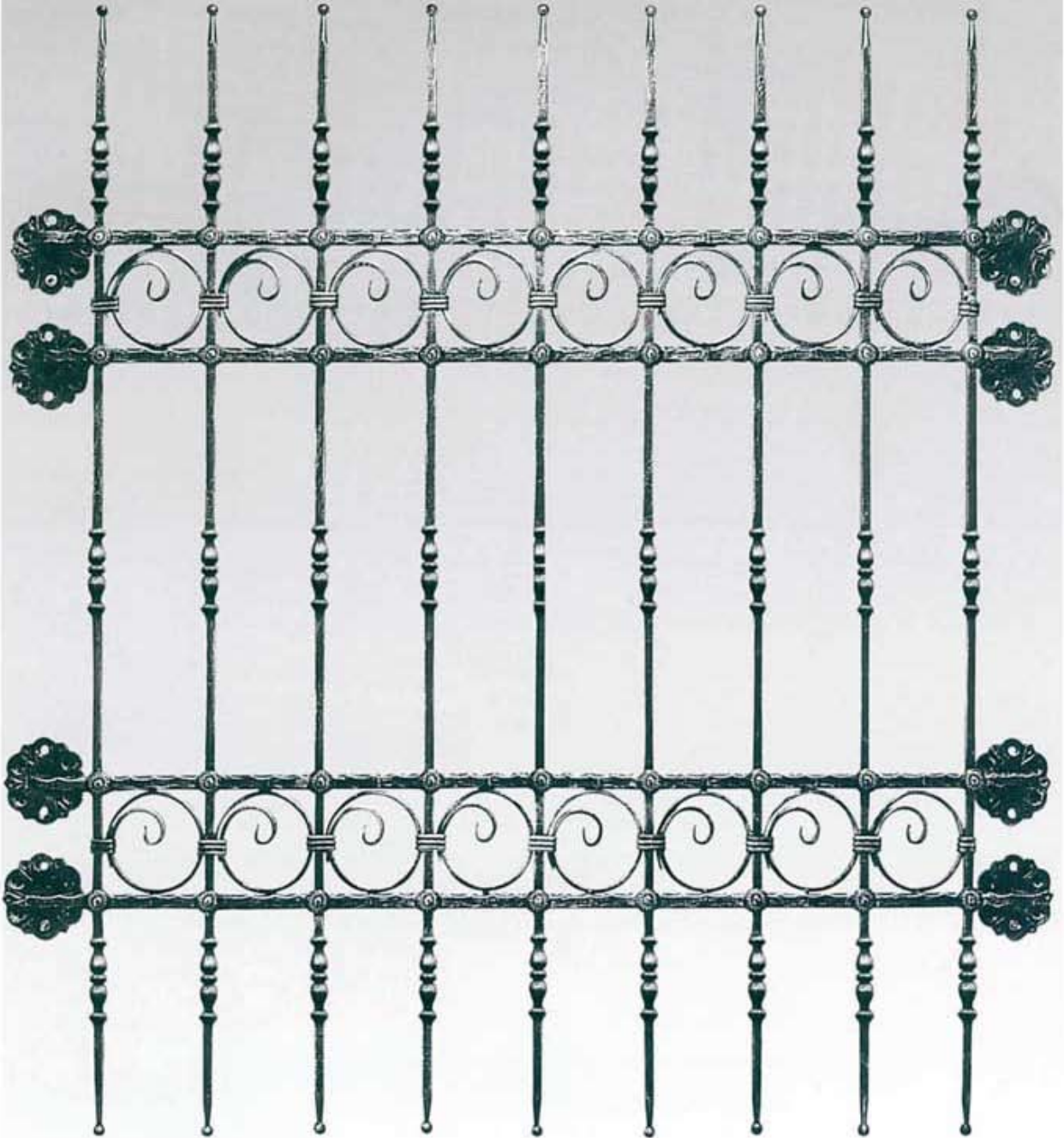

499/162





500/163



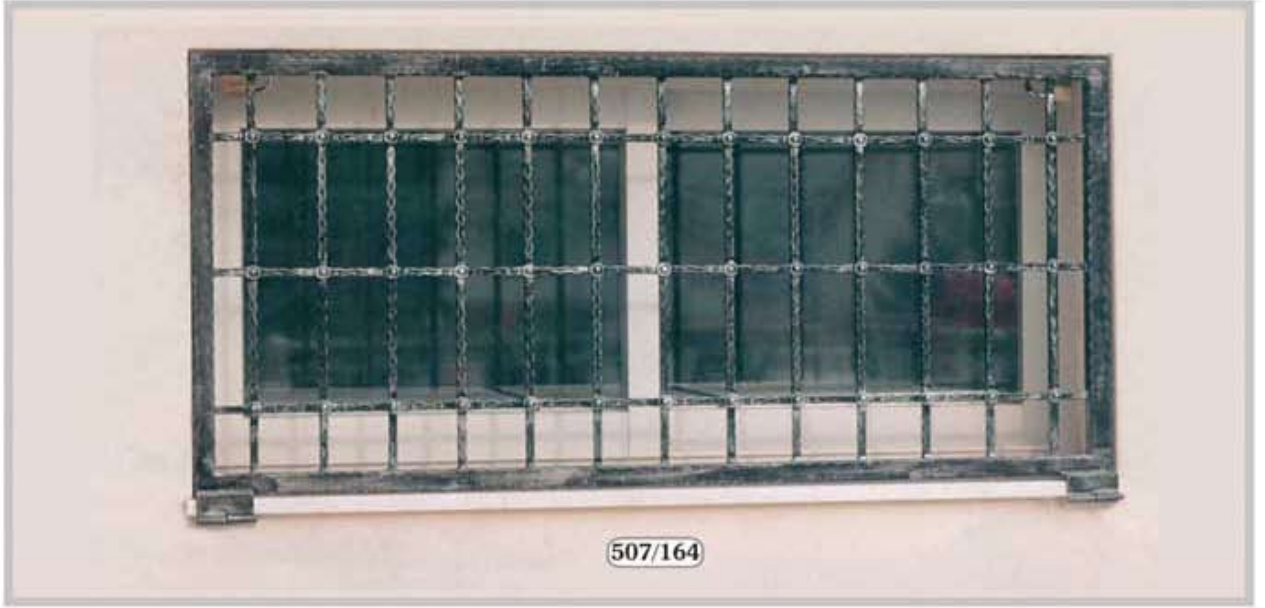





514/165





515/166





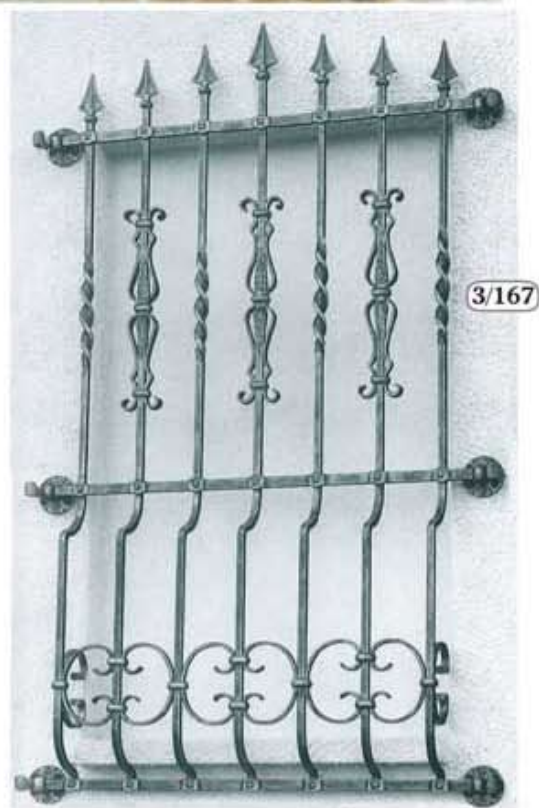
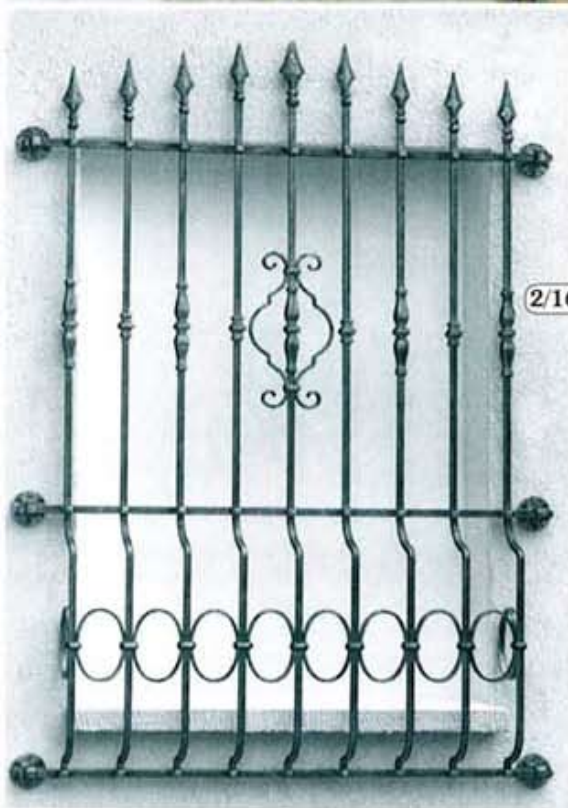
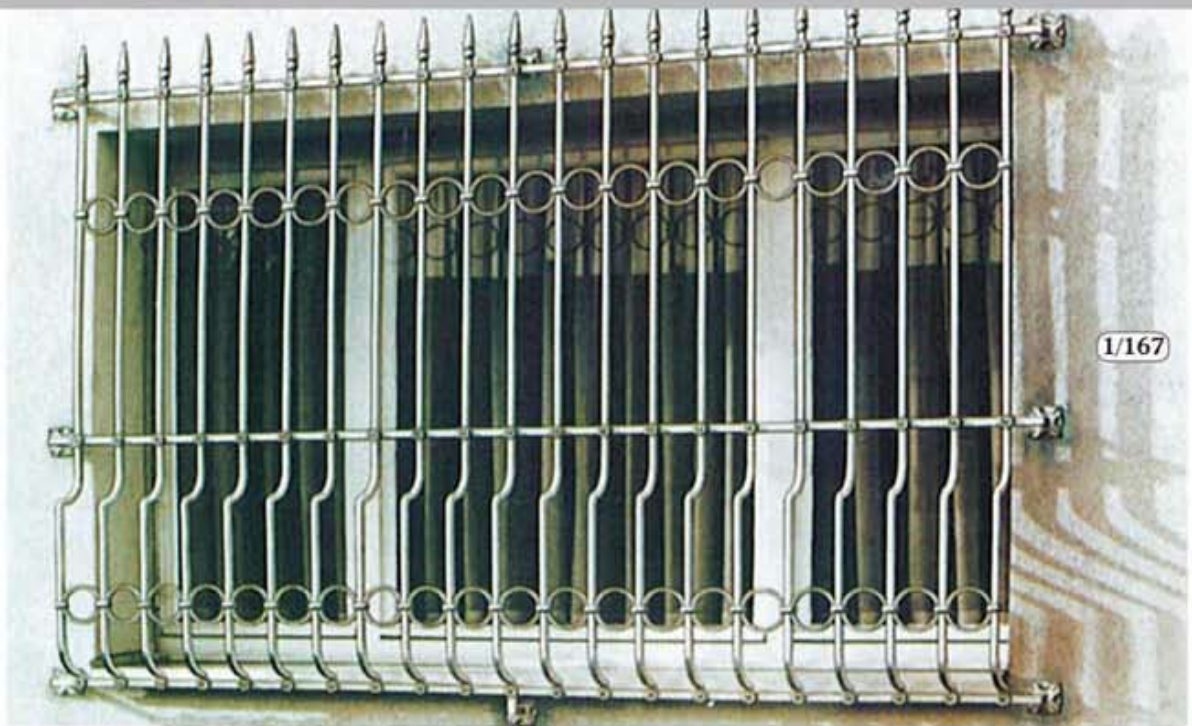



1/168



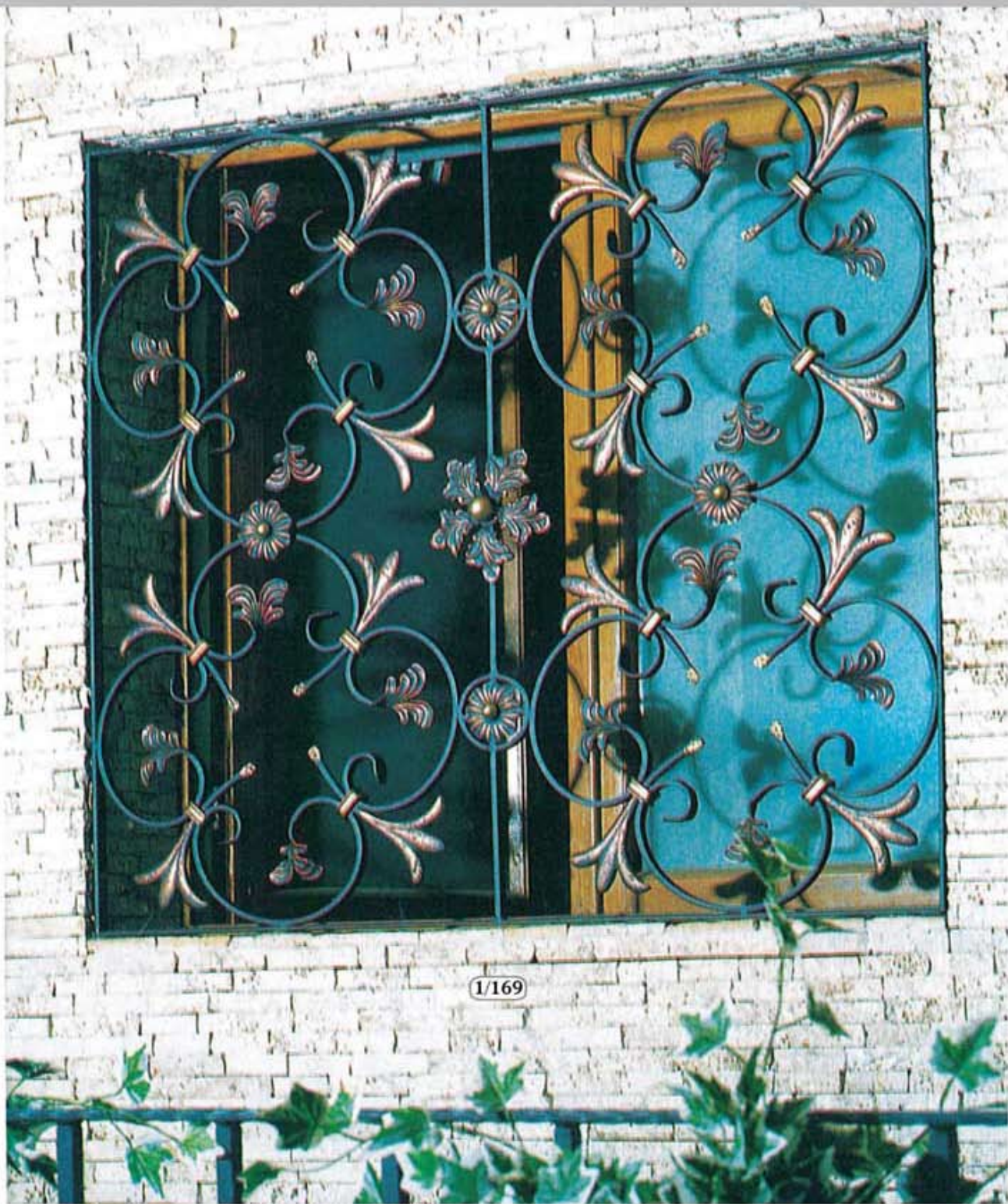

1/169



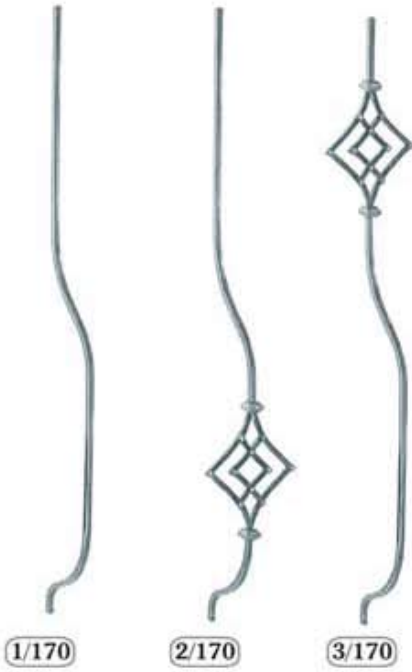





1/171



2/171



3/171

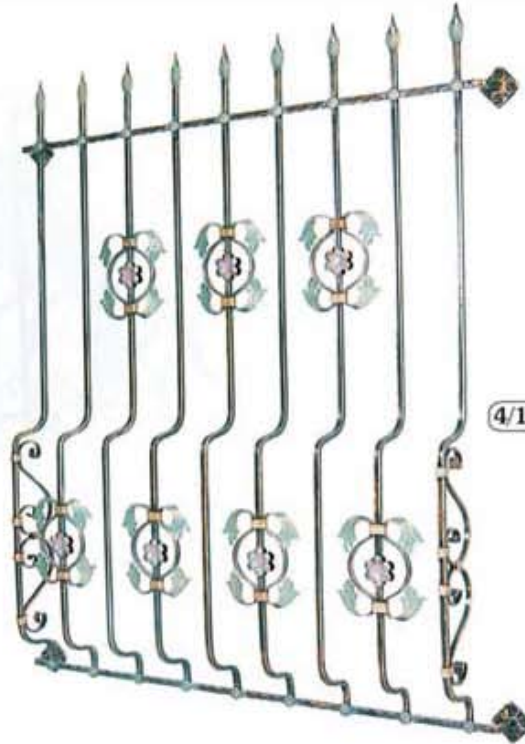

4/171



5/171



6/171



7/171



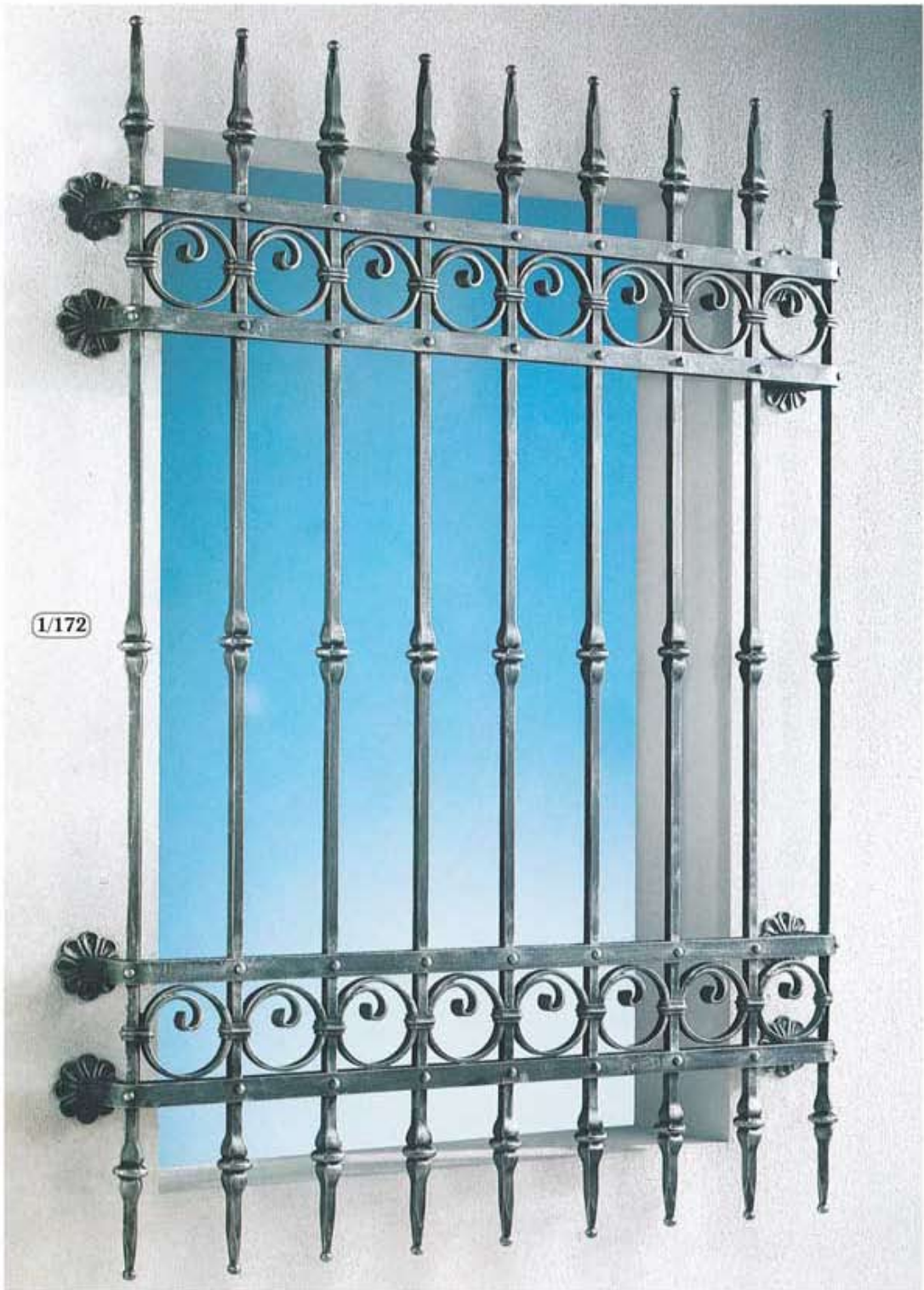

1/172





1/173





2/174 3/174



4/174

5/174







1/175

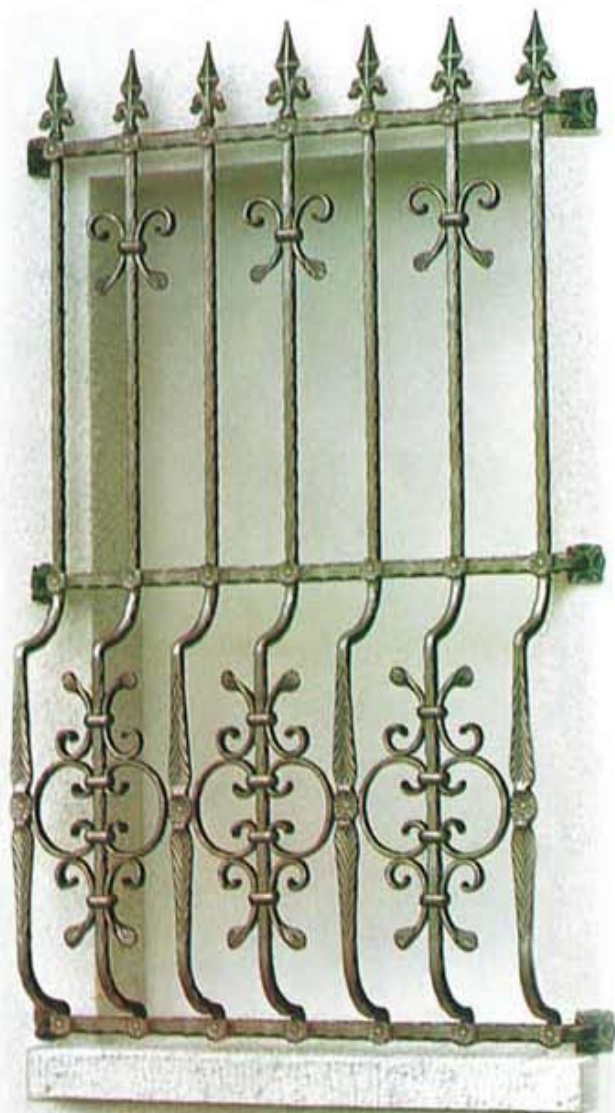

2/175





1/176





# ασφάλειες παραθύρων & διακοσμητικά



236/177 ΚΩΔ. 301686

G x Y mm  
380 x 520 mm



237/177 ΚΩΔ. 301690

G x Y mm  
300 x 390 mm



238/177 ΚΩΔ. 301691

G x Y mm  
300 x 650 mm



239/177 ΚΩΔ. 333960

G x Y mm  
460 x 460 mm



240/177 ΚΩΔ. 301605

G x Y mm  
310 x 520 mm



241/177 ΚΩΔ. 301696

G x Y mm  
510 x 570 mm



243/177 ΚΩΔ. 333220

G x Y mm  
250 x 700 mm



242/177 ΚΩΔ. 302217

G x Y mm  
390 x 120 mm



244/177 ΚΩΔ. 302216

G x Y mm  
800 x 200 mm



245/177 ΚΩΔ. 301603

G x Y mm  
520 x 480 mm



246/177 ΚΩΔ. 302032

G x Y mm  
75 x 500 mm  
75 x 1000 mm

ΔΙΑΚΟΣΜΗΤΙΚΑ



ΔΙΑΚΟΣΜΗΤΙΚΟ

247/178 κωδ. 21204

∅ 35 mm  
G x Y mm  
580 x 1070 mm



248/178 κωδ. 21203

∅ 30 x 10 mm  
G x Y mm  
410 x 1000 mm







**249/179**  
 ∅ 25 mm  
 G.30 x Y.60 mm



**250/179**  
 ∅ 40 mm  
 G.48 x Y.85 mm



**251/179**  
 ∅ 50 mm  
 G.60 x Y.105 mm



**252/179**  
 ∅ 100 mm  
 G.85 x Y.180 mm



**253/179**  
 ∅ 48 mm  
 G.48 x Y.103 mm



**254/179**  
 ∅ 28 mm  
 G.40 x Y.80 mm



**255/179**  
 40 x 40 mm  
 G.40 x Y.50 mm



**256/179**  
 50 x 50 mm  
 G.50 x Y.75 mm



**257/179**  
 60 x 60 mm  
 G.60 x Y.90 mm

**258/179**

80 x 80 mm  
 G.80 x Y.115 mm



**259/179**  
 100 x 100 mm  
 G.110 x Y.155 mm



**260/179**  
 80 x 80 mm  
 G.90 x Y.125 mm



**261/179**  
 60 x 60 mm  
 G.70 x Y.92 mm



**262/179**  
 50 x 50 mm  
 G.60 x Y.83 mm



**263/179**  
 40 x 40 mm  
 G.50 x Y.72 mm



**264/179**  
 30 x 30 mm  
 G.40 x Y.56 mm



**265/179**  
 ∅ 48 mm  
 Y. 115 mm



**266/179**  
 ∅ 40 mm  
 G.40 x Y.90 mm



**267/179**  
 ∅ 42 mm  
 Y. 85 mm

**268/179**  
 ∅ 55 mm  
 G.65 x Y.120 mm



διακοσμητικά



269/180 ΚΩΔ. 1401040

∅ 43 mm  
G x Y mm  
55 x 70 mm



270/180 ΚΩΔ. 1401038

∅ 33 mm  
G x Y mm  
45 x 52 mm



271/180 ΚΩΔ. 1401044

∅ 22 mm  
G x Y mm  
30 x 41 mm



272/180 ΚΩΔ. 972832

∅ 42 mm  
G x Y mm  
80 x 100 mm



273/180 ΚΩΔ. 97283/2

∅ 42 mm  
G x Y mm  
60 x 80 mm



274/180 ΚΩΔ. 27305

140 mm



275/180 ΚΩΔ. 27302

180 mm



276/180 ΚΩΔ. 302064

G x Y mm  
130 x 270 mm



277/180 ΚΩΔ. 302063

G x Y mm  
90 x 170 mm

**ΔΙΑΚΟΣΜΗΤΙΚΑ**



278/180 ΚΩΔ. 30200

G x Y mm  
110 x 240 mm



279/180 ΚΩΔ. 30212

G x Y mm  
110 x 250 mm



280/180 ΚΩΔ. ΠΥΡΓΟΣ

G x Y mm  
150 x 280 mm





**281/181** ΚΩΔ. 301114

φ 14 mm  
G x Y mm  
40 x 24 mm



**282/181** ΚΩΔ. 301113

φ 14 mm  
G x Y mm  
40 x 40 mm



**283/181** ΚΩΔ. 301126

φ 14 ή φ 16 mm  
G x Y mm  
45 x 95 mm



**284/181** ΚΩΔ. 301128

φ 14 ή φ 16 mm  
G x Y mm  
42 x 65 mm



**285/181** ΚΩΔ. 302208

100 x 100 mm  
G x Y mm  
100 x 190 mm



**286/181** ΚΩΔ. 302207

80 x 80 mm  
G x Y mm  
92 x 160 mm



**287/181** ΚΩΔ. 302206

60 x 60 mm  
G x Y mm  
70 x 130 mm



**288/181** ΚΩΔ. 302205

50 x 50 mm  
G x Y mm  
60 x 95 mm



**289/181** ΚΩΔ. 302204

40 x 40 mm  
G x Y mm  
50 x 93 mm



**290/181** ΚΩΔ. 39-0-05

φ 14 mm  
G x Y mm  
40 x 23 mm

**291/181** ΚΩΔ. 39-0-25

φ 16 mm  
G x Y mm  
40 x 23 mm

**292/181** ΚΩΔ. 39-0-24

φ 14 mm  
G x Y mm  
40 x 23 mm



**293/181**  
ΚΩΔ. ΜΠΙΛΙΑ

φ 15 mm

**294/181**  
ΚΩΔ. ΜΠΙΛΙΑ

φ 20 mm

**295/181**  
ΚΩΔ. ΜΠΙΛΙΑ

φ 25 mm

**296/181**  
ΚΩΔ. ΜΠΙΛΙΑ

φ 30 mm

**297/181**  
ΚΩΔ. ΜΠΙΛΙΑ

φ 35 mm

**298/181**  
ΚΩΔ. ΜΠΙΛΙΑ

φ 40 mm

**299/181**  
ΚΩΔ. ΜΠΙΛΙΑ

φ 50 mm

**300/181**  
ΚΩΔ. ΜΠΙΛΙΑ

φ 60 mm

**301/181**  
ΚΩΔ. ΜΠΙΛΙΑ

φ 80 mm

**302/181**  
ΚΩΔ. ΜΠΙΛΙΑ

φ 100 mm





**303/182** κΩΔ. 27119  
G x Y mm  
50 x 180 mm

**304/182**  
κΩΔ. 27120  
G x Y mm  
100 x 330 mm



**305/182**  
κΩΔ. 27118  
G x Y mm  
100 x 330 mm



**306/182** κΩΔ. 27117  
G x Y mm  
110 x 430 mm



**ΦΥΛΛΑΡΆΚΙΑ**



**307/182** κΩΔ. 27205  
G x Y mm  
80 x 120 mm



**308/182** κΩΔ. 27206  
G x Y mm  
80 x 120 mm



**309/182** κΩΔ. 27207  
G x Y mm  
90 x 140 mm



**310/182** κΩΔ. 27208  
G x Y mm  
90 x 140 mm



**311/182** κΩΔ. 27108  
G x Y mm  
90 x 110 mm



**312/182** κΩΔ. 27109  
G x Y mm  
90 x 110 mm



**313/182** κΩΔ. 27112  
G x Y mm  
90 x 160 mm

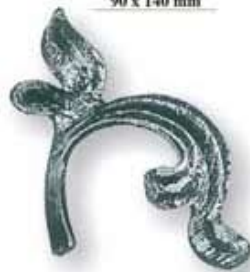

**314/182** κΩΔ. 27113  
G x Y mm  
90 x 160 mm





315/183 ΚΩΔ. 27409

G x Y mm  
30 x 90 mm



316/183 ΚΩΔ. 27410

G x Y mm  
30 x 90 mm



317/183 ΚΩΔ. 27411

G x Y mm  
50 x 115 mm



318/183 ΚΩΔ. 27412

G x Y mm  
50 x 115 mm



319/183 ΚΩΔ. 47407

G x Y mm  
75 x 70 mm



320/183

ΚΩΔ. 27203

G x Y mm  
50 x 100 mm



321/183 ΚΩΔ. 27204

G x Y mm  
50 x 100 mm



322/183 ΚΩΔ. 47408

G x Y mm  
95 x 105 mm



323/183

ΚΩΔ. 301611

G x Y mm  
60 x 80 mm



324/183 ΚΩΔ. 301612

G x Y mm  
60 x 80 mm



325/183 ΚΩΔ. 47906

G x Y mm  
47 x 55 mm



326/183 ΚΩΔ. 27115

G x Y mm  
75 x 100 mm



327/183

ΚΩΔ. 27300

G x Y mm  
120 x 180 mm



328/183 ΚΩΔ. 27303

G x Y mm  
80 x 130 mm



329/183 ΚΩΔ. 47504

G x Y mm  
27 x 60 mm



330/183 ΚΩΔ. 47505

G x Y mm  
35 x 70 mm



331/183 ΚΩΔ. 47506

G x Y mm  
46 x 88 mm

φυλλαράκια





**332/184** ΚΩΔ. 301614  
 ∅ 120 mm



**333/184** ΚΩΔ. 201119  
 ∅ 80 mm



**334/184** ΚΩΔ. 301613  
 ∅ 60 mm



**335/184** ΚΩΔ. 27401  
 ∅ 97 mm



**336/184** ΚΩΔ. 27400  
 ∅ 68 mm



**337/184** ΚΩΔ. 27404  
 ∅ 60 mm



**338/184** ΚΩΔ. 27116  
 ∅ 95 mm



**340/184** ΚΩΔ. 27125  
 ∅ 120 mm



**339/184** ΚΩΔ. 302184  
 ∅ 55 / 90 mm



**341/184** ΚΩΔ. 301094  
 ∅ 40 mm



**342/184** ΚΩΔ. 301095  
 ∅ 50 mm



**343/184** ΚΩΔ. 301096  
 ∅ 60 mm



**344/184** ΚΩΔ. 301097  
 ∅ 90 mm

ΡΟΖΕΤΕΣ/ΜΑΡΓΑΡΙΤΕΣ





345/185 κωδ. 1001005

G x Y mm  
100 x 100 mm

346/185 κωδ. 301893

G x Y mm  
200 x 200 mm



347/185 κωδ. 301864

G x Y mm  
170 x 340 mm



348/185 κωδ. 301100

G x Y mm  
100 x 100 mm



349/185 κωδ. 301099

G x Y mm  
160 x 240 mm

ροzetes/μαργαριτες





**350/186**

20/25/30 mm  
 G x Y mm  
 110 X 110 mm



**351/186**

20/25/30 mm  
 G x Y mm  
 80 X 80 mm



**352/186**

12/14/16 mm  
 G x Y mm  
 65 X 65 mm



**353/186**

12/14/16/20 mm  
 60 X 60 mm



**354/186**

12/14/16 mm  
 Ø 65 mm



**355/186**

12/14/16 mm  
 G x Y mm  
 60 X 60 mm



**356/186**

ΡΟΖΕΤΑ/ΓΟΥΒΑ  
 Ø 33/42/48/60/70/80 mm



**357/186**

ΜΠΡΟΥΤΣΙΝΑ  
 12/14/16 mm  
 G 50 x Y 50 mm  
 12/14/16 mm  
 G 60 x Y 60 mm



**358/186**

Ø 40 mm  
 ΜΠΡΟΥΤΣΙΝΑ



**359/186**

Ø 30 mm  
 ΜΠΡΟΥΤΣΙΝΑ



ΤΑΠΕΣ

**360/186**

30 X 30 mm

**361/186**

40 X 40 mm

**362/186**

50 X 50 mm

**363/186**

60 X 60 mm

**364/186**

80 X 80 mm

**365/186**

30 X 30 mm

**366/186**

40 X 40 mm

**367/186**

50 X 50 mm

**368/186**

60 X 60 mm

**369/186**

80 X 80 mm

ΡΟΖΕΤΕΣ/ΜΑΡΓΑΡΙΤΕΣ





**370/187**

∅ 14 mm  
G 32 x Y 150 mm



**371/187**

∅ 14 mm  
G 28 x Y 85 mm



**372/187**

∅ 14 mm  
G 28 x Y 85 mm



**373/187**

∅ 14 mm  
G 65 x Y 120 mm



**374/187**

∅ 14 mm  
G 55 x Y 175 mm



**375/187**

∅ 14 mm  
G 68 x Y 220 mm



**376/187**

∅ 32 mm  
G 32 x Y 150 mm



**377/187**

∅ 28 mm  
G 28 x Y 85 mm



**378/187**

∅ 28 mm  
G 28 x Y 85 mm



**379/187**

∅ 25 mm  
G 65 x Y 120 mm



**380/187**

∅ 35 mm  
G 63 x Y 125 mm



**381/187**

∅ 28 mm  
G 55 x Y 175 mm



**382/187**

∅ 35 mm  
G 68 x Y 220 mm



**383/187**

∅ 12/14/16 mm  
∅ 20/25/30 mm



**384/1/187**

ΦΛΟΓΑ  
∅ 12/14/16 mm



**384/187**

ΦΛΟΓΑ  
∅ 12/14/16 mm  
∅ 20/25/30 mm



**385/187**

ΝΥΧΑΚΙ  
∅ 12/14/16 mm  
∅ 20/25/30 mm



**386/187**

ΛΟΓΧΗ-ΜΠΙΛΙΑ  
∅ 12/14/16/18/20 mm  
∅ 12/14/16 mm



**387/187**

ΒΕΛΟΝΙ  
∅ 12/14/16 mm  
∅ 20/25/30 mm





**388/188**

≠ 20 x 5 mm  
G x Y mm  
1600 x 470 mm



**389/188**

≠ 20 x 5 mm  
G x Y mm  
1400 x 480 mm



**390/188**

≠ 30 mm  
G x Y mm  
130 x 300 mm



**391/188**

≠ 30 mm  
G x Y mm  
140 x 300 mm



**392/188**

G x Y mm  
520 x 240 mm



**393/188**

G x Y mm  
820 x 370 mm  
(2 ΤΕΜΑΧΙΑ)



αετώματα





**394/189**

± 12 x 6 mm  
G x Y mm  
520 x 80 mm



**396/189**

± 12 x 6 mm  
G x Y mm  
390 x 60 mm

**395/189**

± 16 x 8 mm  
G x Y mm  
530 x 80 mm

**397/189**

± 16 x 8 mm  
G x Y mm  
390 x 60 mm



**398/189**

± 12 x 6 mm  
± 14 x 5 mm  
240 mm



**399/189**

± 12 x 6 mm  
± 14 x 5 mm  
200 mm



**400/189**

± 12 x 6 mm  
± 14 x 5 mm  
130-140-150 mm



**401/189**

± 12 x 6 mm  
± 14 x 5 mm  
110-120 mm



**402/189**

± 12 x 6 mm  
± 14 x 5 mm  
340 mm



**403/189**

± 12 x 6 mm  
± 14 x 5 mm  
280 mm



**404/189**

± 12 x 6 mm  
± 14 x 5 mm  
200 mm



**405/189**

± 12 x 6 mm  
± 14 x 5 mm  
150 mm

## καράβoλα



**406/189**

± 12 x 6 mm  
± 14 x 5 mm  
80/100/110/120 mm



**407/189**

± 12 x 6 mm  
± 14 x 5 mm  
100/110/120 mm



**408/189**

± 12 x 6 mm  
G x Y mm  
120 x 230 mm



**409/189**

± 12 x 6 mm  
G x Y mm  
115 x 300 mm





**410/190**  
Y.230 mm



**411/190**  
Y.150 mm



**412/190**  
Y.120 mm



**413/190**  
≠ 12 x 6 mm  
≠ 14 x 5 mm  
110 & 120 mm



**414/190**  
≠ 12 x 6 mm  
≠ 14 x 5 mm  
110 & 120 mm



**415/190**  
≠ 12 x 6 mm  
≠ 14 x 5 mm  
210 mm



**416/190**  
≠ 12 x 6 mm  
≠ 14 x 5 mm  
290 mm



**417/190**  
≠ 12 x 6 mm  
≠ 14 x 5 mm  
410 mm



**418/190**  
≠ 12 x 6 mm  
≠ 14 x 5 mm  
220 mm



**422/190**  
∅ 6 mm  
G x Y mm  
35 x 220 mm



**423/190**  
∅ 5 mm  
G x Y mm  
50 x 200 mm



**419/190**  
∅ 18 x 60 mm



**13/190**  
ΜΑΙΑΝΔΡΟΣ  
∅ 19 x 6  
∅ 14 x 6



**14/190**



**424/190**  
∅ 12 mm



**15/190**



**425/190**  
N° 12 / 18 / 20  
24 / 26 / 28 / 32



**414/1/190**  
≠ 14 x 5



**499/190**  
∅ 100 - ∅ 120  
≠ 12x5 - 14x5 ΑΠΛΟ  
≠ 12x8 - 14x6 ΣΦΥΡΗΛΑΤΟ





426/191 κωδ. 34600

G x Y mm  
90 x 280 mm



427/191 κωδ. 34415



428/191 κωδ. 34602

∅ 12 mm  
G x Y mm  
50 x 210 mm



429/191 κωδ. 34408



430/191 κωδ. 34403

431/191 κωδ. 34404

432/191 κωδ. 34417



433/191 κωδ. 34407



434/191 κωδ. 34405

435/191 κωδ. 34416



434α/191 κωδ. 34616



435/191 κωδ. 34416



435α/191 κωδ. 34617

πόμολα σφινθήλατα

πόμολα





**ροζέτες κλειδαριάς**



436/192 ΚΩΔ. 34302

G x Y mm  
160 x 290 mm



437/192 ΚΩΔ. 34303

G x Y mm  
160 x 290 mm



438/192 ΚΩΔ. 34300

G x Y mm  
140 x 390 mm



439/192 ΚΩΔ. 34301

G x Y mm  
140 x 390 mm



440/192 ΚΩΔ. 34419

**διακοσμητικά ροζέτες**



441/192 ΚΩΔ. 34304

G x Y mm  
160 x 290 mm



442/192 ΚΩΔ. 34305

G x Y mm  
160 x 290 mm



443/192 ΚΩΔ. 34306

G x Y mm  
135 x 305 mm



444/192 ΚΩΔ. 34307

G x Y mm  
135 x 305 mm



445/192 ΚΩΔ. 34418



446/192 ΚΩΔ. 34308

G x Y mm  
135 x 305 mm



447/192 ΚΩΔ. 34309

G x Y mm  
90 x 295 mm



448/192 ΚΩΔ. 34310

G x Y mm  
90 x 295 mm



449/192 ΚΩΔ. 34400



450/192 ΚΩΔ. 34400/0



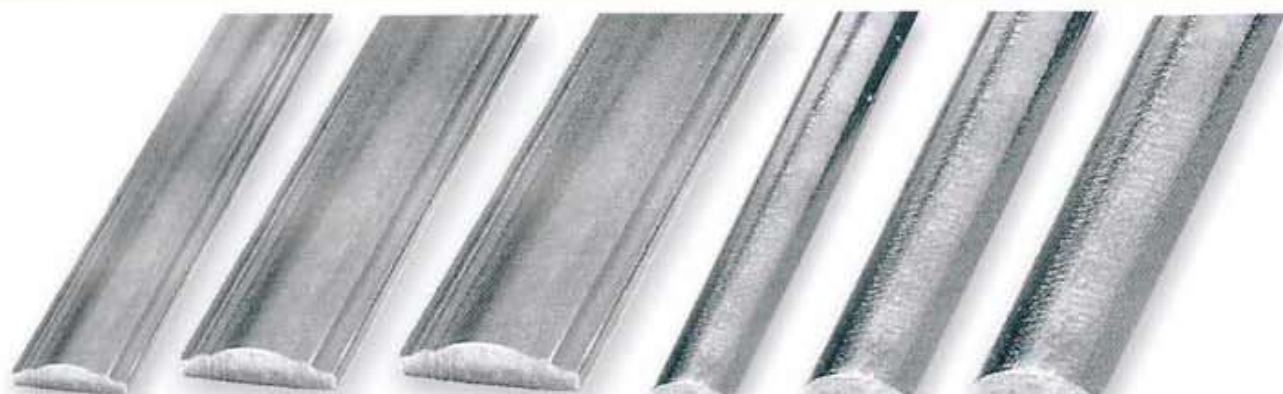

**176/193**

ΛΑΜΑ ΠΟΜΠΕ  
40 x 11

**177/193**

ΛΑΜΑ ΠΟΜΠΕ  
50 x 14

**178/193**

ΛΑΜΑ ΠΟΜΠΕ  
60 x 16

**179/193**

ΛΑΜΑ ΠΟΜΠΕ  
30 x 8

**180/193**

ΛΑΜΑ ΠΟΜΠΕ  
40 x 8

**181/193**

ΛΑΜΑ ΠΟΜΠΕ  
50 x 10



**182/193**

ΤΕΛΕΙΩΜΑ  
ΚΟΥΠΑΣΤΗΣ  
40 x 11

**183/193**

ΤΕΛΕΙΩΜΑ  
ΚΟΥΠΑΣΤΗΣ  
50 x 14

**184/193**

ΤΕΛΕΙΩΜΑ  
ΚΟΥΠΑΣΤΗΣ  
60 x 16

**185/193**

ΤΕΛΕΙΩΜΑ  
ΚΟΥΠΑΣΤΗΣ  
30 x 8

**186/193**

ΤΕΛΕΙΩΜΑ  
ΚΟΥΠΑΣΤΗΣ  
40 x 8

**187/193**

ΤΕΛΕΙΩΜΑ  
ΚΟΥΠΑΣΤΗΣ  
50 x 10

**ΚΟΥΠΑΣΤΕΣ**



**188/193**

ΛΑΜΑ  
40 x 8  
ΣΤΑΦΥΛΙ



**190/193**

ΛΑΜΑ  
40x8 - 50x8  
ΣΦΥΡΗΛΑΤΗ



**189/193**

ΤΕΛΕΙΩΜΑ  
ΚΟΥΠΑΣΤΗΣ  
40 x 8  
ΛΟΥΛΟΥΙ



**191/193**

ΛΑΜΑ  
40 x 8  
ΛΟΥΛΟΥΙ



σφυρήλατα διάτρητα



**192/194**

∅14/16/18/20 mm  
 ΜΗΚΟΣ 2 m



**193/194**

∅ 14/16/20 mm  
 ΜΗΚΟΣ 2 m



**194/194**

∅ 12/14/16/20 mm  
 ΜΗΚΟΣ 3 m ή 6 m



**195/194**

∅ 12/14/16 mm  
 ΜΗΚΟΣ 3 m ή 6 m



**196/194**

ΣΦΥΡΗΛΑΤΑ  
 ∅ 12/14/16/20/25/30 mm  
 ∅ 12/14/16/20/25/30 mm  
 ΜΗΚΟΣ 3 m



**197/194**

ΣΦΥΡΗΛΑΤΗ  
 ≠ 25 x 6 / 20 x 8 mm  
 ≠ 30 x 6 mm  
 ΜΗΚΟΣ 4 m



**198/194**

ΣΦΥΡΗΛΑΤΟ  
 ∅ 14/16 mm  
 ΜΗΚΟΣ 2 m



**199/194**

ΣΦΥΡΗΛΑΤΗ  
 ΚΟΥΡΜΙΑΡΙΣΤΗ  
 ≠ 40 x 8 mm  
 ΜΗΚΟΣ 2 m



**200/194**

ΚΟΥΡΜΙΑΡΙΣΤΗ  
 ≠ 25 x 6 mm  
 ΜΗΚΟΣ 2 m



# σφυρήλατα & διάτρητα σφυρήλατα



**1/195**

Ø 10/12/14/16/18/20/22/25/30/40 mm  
μήκος 3 μ.



**2/195**

4 Ø 8  
μήκος 3 μ.

4 Ø 10  
μήκος 3 μ.

4 Ø 12  
μήκος 3 μ.

4 Ø 14  
μήκος 3 μ.

4 Ø 16  
μήκος 3 μ.



**3/195**

4 - 8 x 8 mm  
μήκος 3 μ.

4 - 10 x 10 mm  
μήκος 3 μ.

4 - 12 x 12 mm  
μήκος 3 μ.

4 - 14 x 14 mm  
μήκος 3 μ.

4 - 16 x 16 mm  
μήκος 3 μ.



**6/195**

- 12 X 12 mm
  - 14 X 14 mm
  - 16 X 16 mm
  - 18 X 18 mm
  - 20 X 20 mm
  - 22 X 22 mm
  - 25 X 25 mm
  - 30 X 30 mm
  - 40 X 40 mm
- μήκος 3 μ. ή 6 μ.



**196/195**

- 12 X 12 mm
- 14 X 14 mm
- 16 X 16 mm
- 18 X 18 mm

- 20 X 20 mm
- 22 X 22 mm
- 25 X 25 mm
- 30 X 30 mm

μήκος 3 μ. ή 6 μ.



**ΚΟΙΛΟΔΟΚΟΙ  
ΣΦΥΡΗΛΑΤΟΙ**

**4/195**

- 25 X 25 mm
- 30 X 30 mm
- 40 X 40 mm
- 50 X 50 mm
- 60 X 60 mm
- 40 X 30 mm
- 50 X 30 mm
- 60 X 30 mm
- 60 X 40 mm
- 80 X 40 mm

μήκος 3 μ. ή 6 μ.



**ΔΟΥΚΑΣ®**  
ΣΥΣΤΗΜΑΤΑ ΑΒΟΥΜΙΝΩΣΤΩ - ΜΕΣΑΝΩΜΑΤΑ



**καράβολα**



**420/196**

- ≠ 20 x 6 mm
- ≠ 25 x 6 mm
- ≠ 30 x 6 mm
- ≠ 30 x 10 mm
- Υ 0,70



**421/196**

- ☑ 12/14/16/20 mm
- ☑ 25/30 mm
- Υ 0,70



**3/196**

- ☑ 12/14/16/18/20/25/30 mm
- ☑ 12/14/16/18/20/22/25/30 mm



**4/196**

- ☑ 12/14/16/18 mm
- ☑ 12/14/16/18/20 mm



**5/196**

- ☑ 12/14/16/18 mm



**6/196**

- ☑ 12/14/16/18/20 mm



**7/196**

- ≠ 12 x 8 mm
- ≠ 14 x 8 mm
- ≠ 16 x 8 mm
- ≠ 20 x 8 mm
- ≠ 30 x 8 mm
- ≠ 20 x 10 mm
- ≠ 30 x 10 mm



**8/196**

- ≠ 12 x 12 mm
- ≠ 14 x 14 mm
- ≠ 16 x 16 mm
- ≠ 18 x 18 mm
- ≠ 20 x 20 mm



**9/196**

- ☑ 12 mm
- ☑ 14 mm
- ☑ 16 mm
- ☑ 18 mm
- ☑ 20 mm

**Καράβολα**

Όλα τα παραπάνω καράβολα παράγονται κατόπιν παραγγελίας από οποιαδήποτε λάμα και σε οποιαδήποτε διάσταση.





621/197

ΛΑΜΑ ≠ 40 x 8 mm



622/197

ΛΑΜΑ ≠ 50 x 8 mm



623/197

ΛΑΜΑ ≠ 40 x 8 mm



624/197

ΛΑΜΑ ≠ 40 x 8 mm



625/197

ΛΑΜΑ ≠ 40 x 8 mm



626/197

ΛΑΜΑ ≠ 50 x 8 mm



627/197

ΛΑΜΑ ≠ 40 x 8 mm



628/197

ΛΑΜΑ ≠ 50 x 8 mm



629/197

ΛΑΜΑ ≠ 40 x 8 mm



630/197

ΛΑΜΑ ≠ 50 x 8 mm



**631/198**  
 ΛΑΜΑ  
 ≠ 40 x 8 mm



**632/198**  
 ΛΑΜΑ  
 ≠ 40 x 8 mm  
 ≠ 50 x 8 mm



**633/198**  
 ΛΑΜΑ  
 ≠ 40 x 8 mm  
 ≠ 50 x 8 mm



**634/198**  
 ΛΑΜΑ  
 ≠ 40 x 8 mm  
 ≠ 50 x 8 mm



**635/198**  
 ΛΑΜΑ  
 ≠ 40 x 8 mm  
 ≠ 50 x 8 mm



**636/198**  
 ΛΑΜΑ  
 ≠ 40 x 8 mm  
 ≠ 50 x 8 mm



**637/198**  
 ΛΑΜΑ  
 ≠ 40 x 8 mm  
 ≠ 50 x 8 mm



**4/198**  
 ≠ 40 x 8 mm  
 ≠ 50 x 8 mm

**5/198**  
 ≠ 40 x 8 mm  
 ≠ 50 x 8 mm



**7/198**  
 ≠ 40 x 8 mm  
 ≠ 50 x 8 mm



**541/198**  
 Ø 30



## ΚΟΥΠΑΣΤΕΣ





155/199  
∅ 25 mm



156/199  
∅ 25 mm



157/199  
∅ 25 mm



158/199  
∅ 25 mm



159/199  
∅ 25 mm



160/199  
∅ 25 mm

ΤΕΛΕΙΩΜΑΤΑ ΚΟΛΩΝΑΣ



161/199  
∅ 30 mm  
G x Y mm  
80 x 140 mm



162/199  
∅ 25 mm  
G x Y mm  
50 x 160 mm



163/199  
∅ 20 mm  
G x Y mm  
55 x 100 mm



164/199  
∅ 20 mm  
G x Y mm  
60 x 110 mm



**στηρίγματα κουπαστής**



**165/200**  
 ΧΥΤΗ  
 Y.970 x G.70 mm



**166/200**  
 ΧΥΤΗ  
 Y.970 x G.70 mm



**167/200**  
 ∅ 20 mm



**168/200**  
 ∅ 25 mm  
 ∅ 25 mm



**169/200**  
 ∅ 20 mm



**170/200**  
 ∅ 25 mm



**171/200**  
 ∅ 30 mm



**172/200**  
 ∅ 40 mm



**173/200**  
 ∅ 12 mm  
 G x Y mm  
 95 x 180 mm



**174/200**  
 ∅ 12 mm  
 G x Y mm  
 70 x 180 mm



**175/200**  
 ∅ 20 mm  
 G x Y mm  
 210 x 420 mm

ΚΟΛΩΝΕΣ





**610/201**  
 $\varnothing$  25 mm  
 G x Y  
 60 x 1200 mm



**638/201**  
 $\varnothing$  25 mm  
 Y 1200 mm



**639/201**  
 $\varnothing$  25 mm  
 Y 1200 mm



**640/201**  
 $\varnothing$  25 mm  
 G x Y  
 40 x 1200 mm



**641/201**  
 $\varnothing$  16/20/25 mm  
 Y 1200 mm



**642/201**  
 $\varnothing$  55 mm  
 G x Y  
 55 x 1200 mm



**1/201**  
 $\varnothing$  12/14/16/20 mm  
 $\varnothing$  12/14/16/20 mm



**2/201**  
 $\varnothing$  12/14/16/20 mm  
 $\varnothing$  12/14/16/20 mm



**3/201**  
 $\varnothing$  12/14/16/20 mm  
 $\varnothing$  12/14/16/20 mm



**4/201**  
 $\varnothing$  12/14/16 mm  
 $\varnothing$  12/14/16 mm



**5/201**  
 $\varnothing$  12/14/16/20 mm  
 $\varnothing$  12/14/16/20 mm



**6/201**  
 $\varnothing$  12/14/16/20/25/30 mm  
 $\varnothing$  12/14/16/20/25/30 mm

**Καράβoλα**



**207/202**

∅ 14 mm  
 Y 800 mm



**208/202**

∅ 12/14 mm  
 Y 800 mm



**209/202**

∅ 12/14 mm  
 Y 800 mm



**210/202**

∅ 12/14/16 mm  
 Y 800 mm



**211/202**

∅ 12/14/16 mm  
 Y 800 mm



**212/202**

∅ 12/14/16 mm  
 Y 800 mm



**213/202**

∅ 12/14/16 mm  
 Y 800 mm



**214/202**

∅ 12/14/16 mm  
 ∅ 12/14/16 mm  
 Y 800 mm



**215/202**

∅ 12/14 mm  
 ∅ 12/14 mm  
 Y 800 mm



**216/202**

∅ 30 mm  
 Y 900 mm



**217/202**

∅ 30 mm  
 Y 900 mm



**218/202**

∅ 42 mm  
 Y 1200 mm



**219/202**

∅ 30 mm  
 Y 900 mm



**220/202**

∅ 30 mm  
 Y 900 mm



**221/202**

∅ 30 mm  
 Y 900 mm





**222/203**

∅ 40 mm  
Y 900 mm



**223/203**

∅ 30 mm  
Y 900 mm



**224/203**

∅ 12/14 mm  
Y 800 mm



**225/203**

∅ 12/14 mm  
Y 800 mm



**226/203**

∅ 12/14 mm  
Y 800 mm



**227/203**

≠ 14 x 8 mm  
≠ 16 x 8 mm  
Y 800 mm



**228/203**

≠ 14 x 8 mm  
≠ 16 x 8 mm  
Y 800 mm



**229/203**

∅ 14/16 mm  
Y 800 mm



**230/203**

∅ 14 mm  
Y 800 mm



**231/203**

∅ 14 mm  
Y 800 mm



**232/203**

∅ 14 mm  
Y 800 mm



**233/203**

∅ 14 mm  
Y 800 mm



**70/203**

∅ 14/16/18/20 mm  
Y 800 mm



**71/203**

∅ 14/16/18/20 mm  
Y 800 mm



**72/203**

∅ 12/14 mm  
Y 800 mm



**73/203**

∅ 12/14 mm  
Y 800 mm



**69/203**

∅ 12/14/16 mm  
Y 800 mm



**69/1/203**

∅ 12/14/16 mm  
Y 800 mm





**581A/204**  
 $\varnothing$  12/14 mm  
 Y 800 mm



**581B/204**  
 $\varnothing$  12/14 mm  
 Y 800 mm



**586/204**  
 $\varnothing$  12/14 mm  
 Y 800 mm



**584/204**  
 $\varnothing$  12/14 mm  
 Y 800 mm



**5/204**  
 $\varnothing$  12/14 mm  
 Y 800 mm



**6/204**  
 $\varnothing$  12/14 mm  
 Y 800 mm



**7/204**  
 $\varnothing$  12/14 mm  
 Y 800 mm



**8/204**  
 $\varnothing$  12/14 mm  
 Y 800 mm



**9/204**  
 $\varnothing$  14/16/18/20 mm  
 Y 800 mm



**10/204**  
 $\varnothing$  42  
 Y 800 mm



**11/204**  
 $\varnothing$  42  
 Y 800 mm



**12/204**  
 $\varnothing$  32  
 Y 800 mm



**13/204**  
 $\varnothing$  32  
 Y 800 mm



**14/204**  
 $\varnothing$  12/14/16 mm  
 Y 800 mm



**15/204**  
 $\varnothing$  12/14/16 mm  
 Y 800 mm



**535/204**  
 $\varnothing$  12 mm  
 Y 800 mm



**536/204**  
 $\varnothing$  12 mm  
 Y 800 mm

Σ ω λ η ν ω τ ά





451/205 κολ. 37116



452/205 κολ. 37115



453/205 κολ. 37103



454/205 κολ. 37102



455/205 κολ. 37101



456/205 κολ. 37100  
Υ. 1890 mm



457/205 κολ. 37120



458/205 κολ. 37121

ΦΩΤΙΣΤΙΚΑ





459/206 ΚΩΔ. 36104  
14 kg



460/206 ΚΩΔ. 37125  
2,5 m  
23,5 kg



461/206 ΚΩΔ. 37124  
2,5 m  
18,350 kg

εξαρτήματα



462/206 ΚΩΔ. 37409



463/206 ΚΩΔ. 37500







**464/207** κωδ. **37713**  
 5,500 kg  
 G x Y x D  
 ∅ 320x1100x375 mm



**466/207** κωδ. **37705**  
 3,930 kg  
 G x Y x D  
 ∅ 565x200x230 mm



**467/207** κωδ. **37703**  
 5,260 kg  
 G x Y x D  
 ∅ 600x290x280 mm



**468/207** κωδ. **37700**  
 3,510 kg  
 G x Y x D  
 ∅ 700x280x245 mm



**465/207** κωδ. **37711**  
 6,420 kg  
 G x Y x D  
 ∅ 400x1000x500 mm



**469/207** κωδ. **37712**  
 5,310 kg  
 G x Y x D  
 ∅ 600x530x310 mm



**470/207** κωδ. **37702**  
 0,660 kg  
 G x Y x D  
 ∅ 75x200x140 mm



590/208



591/208



592/208



593/208





643/209

ΛΑΜΑ 30X8  
Χειροποίητο τελείωμα,  
διαστάσεις  
κατόπιν παραγγελίας  
από 1,00 - 1,50 m.



644/209

ΛΑΜΑ 30X8  
Χειροποίητο τελείωμα,  
διαστάσεις  
από 0,70 - 1,20 m.



645/209

ΛΑΜΑ 30X8  
Χειροποίητο τελείωμα,  
διαστάσεις  
κατόπιν παραγγελίας  
από 0,70 - 1,20 m.



646/209

ΛΑΜΑ 30X8  
Χειροποίητο τελείωμα,  
διαστάσεις  
από 1,00 - 1,50 m.



**47/210**  
∅ 16 x 8 mm  
G x Y mm  
660 x 715 mm



**48/210**  
∅ 12 mm  
G x Y mm  
170 x 800 mm



**49/210**  
∅ 14/16 mm  
G x Y mm  
110 x 800 mm



**50/210**  
∅ 14 mm  
G x Y mm  
165 x 800 mm



**51/210**  
∅ 14 mm  
G x Y mm  
80 x 1000 mm



**52/210**  
∅ 14 mm  
G x Y mm  
215 x 1000 mm



**53/210**  
∅ 14/16 mm  
G x Y mm  
155 x 1000 mm



**54/210**  
∅ 14 mm  
G x Y mm  
165 x 800 mm



**55/210**  
∅ 12/14 mm  
G x Y mm  
210 x 800 mm





**57/211**

∅ 16 mm

G x Y mm

155 x 1000 mm



**58/211**

∅ 16 mm

G x Y mm

140 x 1000 mm



**59/211**

∅ 16 x 8 mm

G x Y mm

120 x 800 mm



**60/211**

∅ 12/14/16 mm

G x Y mm

310 x 900 mm



**61/211**

∅ 14/16 mm

G x Y mm

160 x 800 mm



**62/211**

∅ 12 mm

G x Y mm

240 x 900 mm



**63/211**

∅ 16 mm

G x Y mm

120 x 600 mm



**65/211**

∅ 12/14 mm

G x Y mm

190 x 800 mm



**66/211**

∅ 14 x 6 mm

G x Y mm

240 x 800 mm



**67/211**

∅ 12 mm

Y mm

800 mm



**68/211**

∅ 12 mm

Y mm

800 mm



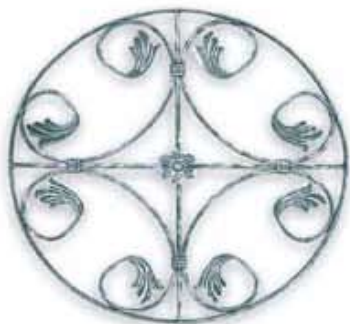

**97/212**  
 ≠ 12 x 6 mm  
 G x Y mm  
 Ø 500 mm



**98/212**  
 ≠ 12 x 6 mm  
 G x Y mm  
 300 x 300 mm



**99/212**  
 ≠ 12 x 6 mm  
 G x Y mm  
 300 x 300 mm



**100/212**  
 ≠ 16 x 8 mm  
 G x Y mm  
 670 x 640 mm



**101/212**  
 ≠ 16 x 8 mm  
 G x Y mm  
 880 x 370 mm



**102/212**  
 ≠ 16 x 8 mm  
 G x Y mm  
 780 x 780 mm

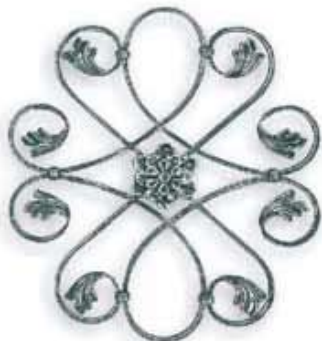

**103/212**  
 ≠ 16 x 8 mm  
 G x Y mm  
 510 x 590 mm

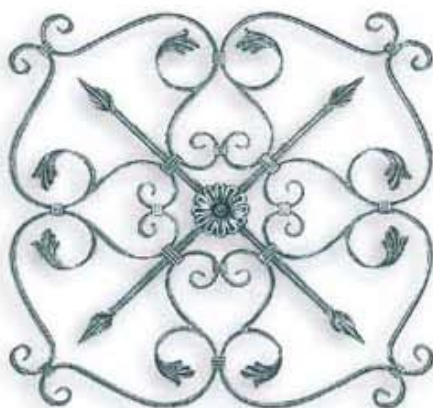

**104/212**  
 ≠ 16 x 8 mm  
 G x Y mm  
 700 x 700 mm

**ΜΟΤΙΦ**





**105/213**

∅ 12 mm  
G x Y mm  
250 x 800 mm



**106/213**

∅ 12 mm  
G x Y mm  
235 x 800 mm



**107/213**

∅ 12 mm  
G x Y mm  
360 x 800 mm



**108/213**

∅ 12 mm  
G x Y mm  
200 x 800 mm



**109/213**

∅ 12 mm  
G x Y mm  
200 x 800 mm



**110/213**

∅ 12 mm  
G x Y mm  
210 x 800 mm



**111/213**

∅ 12 mm  
G x Y mm  
210 x 800 mm



**112/213**

∅ 12 mm  
G x Y mm  
250 x 800 mm



**113/213**

∅ 12 mm  
G x Y mm  
250 x 800 mm



**114/213**

∅ 12 mm  
G x Y mm  
320 x 800 mm

μοτίφ



**115/214**

∅ 12 mm  
 G x Y mm  
 145 x 900 mm



**116/214**

∅ 12 mm  
 G x Y mm  
 260 x 800 mm



**117/214**

∅ 12 mm  
 G x Y mm  
 150 x 800 mm



**118/214**

∅ 12 mm  
 G x Y mm  
 155 x 800 mm



**119/214**

∅ 12 mm  
 G x Y mm  
 155 x 800 mm

**ΜΟΤΙΦ**



**120/214**

∅ 14 mm  
 G x Y mm  
 200 x 800 mm



**121/214**

∅ 12 mm  
 G x Y mm  
 210 x 800 mm



**122/214**

∅ 14 mm  
 G x Y mm  
 285 x 500 mm



**123/214**

≠ 14 x 8 mm  
 G x Y mm  
 360 x 800 mm





**124/215**

∅ 12 mm

G x Y mm

300 x 800 mm



**125/215**

∅ 12 mm

G x Y mm

265 x 800 mm



**126/215**

∅ 12 mm

G x Y mm

145 x 800 mm



**127/215**

∅ 12 mm

G x Y mm

145 x 800 mm



**128/215**

∅ 12 mm

G x Y mm

195 x 800 mm

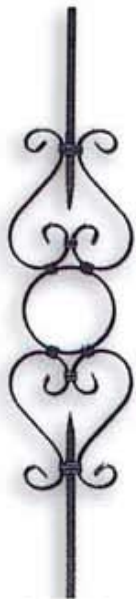

**129/215**

∅ 12 mm

G x Y mm

170 x 800 mm



**130/215**

∅ 12 mm

G x Y mm

180 x 800 mm



**131/215**

∅ 12 mm

G x Y mm

180 x 800 mm



**132/215**

∅ 12 mm

G x Y mm

240 x 800 mm



**133/215**

∅ 12 mm

G x Y mm

195 x 800 mm



**134/215**

∅ 12 mm

G x Y mm

250 x 800 mm



**135/216**

Ø 12 mm  
 G x Y mm  
 180 x 900 mm



**136/216**

Ø 12 mm  
 G x Y mm  
 125 x 900 mm



**137/216**

Ø 12 mm  
 G x Y mm  
 155 x 900 mm



**138/216**

≠ 16 x 8 mm  
 G x Y mm  
 195 x 800 mm



**139/216**

≠ 16 x 8 mm  
 G x Y mm  
 195 x 800 mm



**140/216**

≠ 16 x 8 mm  
 G x Y mm  
 165 x 800 mm

**ΜΟΤΙΦ**



**141/216**

Ø 12 mm  
 G x Y mm  
 110 x 800 mm



**142/216**

Ø 12 mm  
 G x Y mm  
 110 x 800 mm



**143/216**

Ø 12 mm  
 G x Y mm  
 180 x 800 mm



**144/216**

Ø 12 mm  
 G x Y mm  
 125 x 800 mm



**145/216**

Ø 16 mm  
 G x Y mm  
 105 x 900 mm



**146/216**

Ø 14/16 mm  
 G x Y mm  
 60 x 900 mm



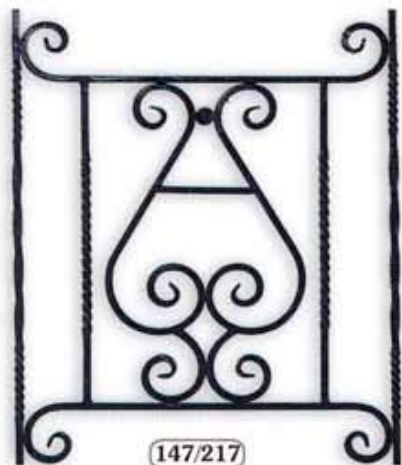

**147/217**  
 $\varnothing$  12/14 mm  
 G x Y mm  
 620 x 800 mm

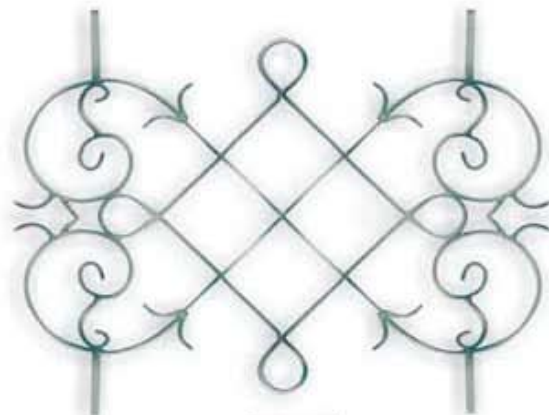

**148/217**  
 $\varnothing$  12 x 6 mm  
 G x Y mm  
 850 x 700 mm

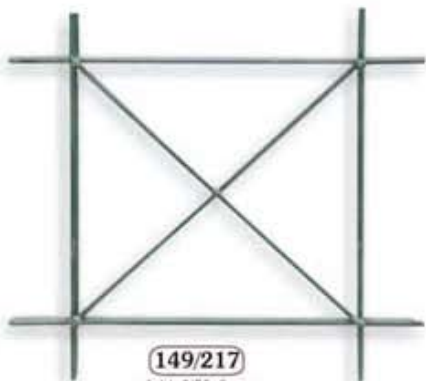

**149/217**  
 $\varnothing$  14x6/20x6 mm  
 $\varnothing$  12/14/16 mm  
 ΔΙΑΣΤΑΣΗ  
 45X45 - 55X55



**150/217**  
 $\varnothing$  16 x 8 mm  
 G x Y mm  
 350 x 400 mm



**151/217**  
 $\varnothing$  16 x 6 mm  
 G x Y mm  
 $\varnothing$  300 mm



**152/217**  
 $\varnothing$  12 x 6 mm  
 G x Y mm  
 450 x 450 mm



**153/217**  
 $\varnothing$  12 mm  
 G x Y mm  
 400 x 480 mm



**154/217**  
 $\varnothing$  8 mm  
 G x Y mm  
 250 x 250 mm



**201/218**

∅ 12/14 mm  
Y 800/1.200 mm  
Y 1500/1.850 mm



**202/218**

∅ 12/14 mm  
Y 800/1.200 mm  
Y 1500/1.850 mm



**203/218**

∅ 12/14 mm  
Y 800 mm



**204/218**

∅ 12/14 mm  
Y 800/1.200 mm  
Y 1.500/1.850 mm



**205/218**

∅ 12/14 mm  
Y 800/1.200 mm  
Y 1500/1.850 mm



**206/218**

∅ 12/14 mm  
Y 800 mm

**Λωσθήρες και Ξαίεγγραφα**



**529/218**

∅ 12 mm  
1.470 kg  
G x Y mm  
120 x 310 x 1000



**530/218**

∅ 12 mm  
1.300 kg  
G x Y mm  
50 x 230 x 1000



**531/218**

∅ 12 mm  
1.390 kg  
G x Y mm  
85 x 400 x 1000



**532/218**

∅ 12 mm  
1.390 kg  
G x Y mm  
85 x 340 x 1000



**604/218**

∅ 14 mm  
G x Y mm  
195 x 800 mm



**605/218**

∅ 12 mm  
G x Y mm  
125 x 800 mm



**606/218**

∅ 12 mm  
G x Y mm  
110 x 800 mm





**607/219**

∅ 14 mm  
G x Y mm  
35 x 800 mm



**608/219**

∅ 14 mm  
G x Y mm  
40 x 800 mm



**609/219**

∅ 14 mm  
G x Y mm  
40 x 800 mm



**611/219**

∅ 12 mm  
G x Y mm  
160 x 800 mm



**612/219**

∅ 12 mm  
G x Y mm  
130 x 800 mm



**613/219**

∅ 12 mm  
G x Y mm  
135 x 800 mm

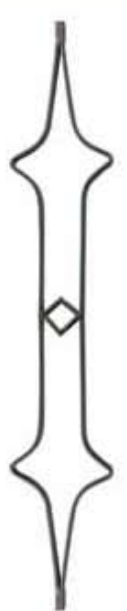

**614/219**

∅ 12 x 6 mm  
G x Y mm  
130 x 800 mm



**615/219**

∅ 12 x 6 mm  
G x Y mm  
140 x 800 mm



**616/219**

∅ 12 mm  
G x Y mm  
75 x 800 mm



**617/219**

∅ 12 mm  
G x Y mm  
75 x 800 mm



**618/219**

∅ 12 mm  
G x Y mm  
240 x 800 mm



**619/219**

∅ 12 mm  
G x Y mm  
360 x 650 mm

**234/219**

∅ 14 mm  
Y 800 mm

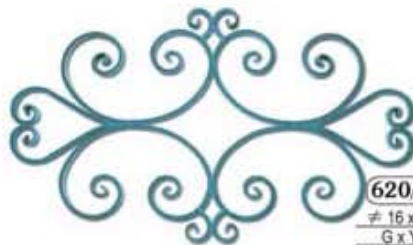

**620/219**

∅ 16 x 8 mm  
G x Y mm  
450 x 800 mm



**235/219**

∅ 14 mm  
Y 800 mm



**554/220**  
 ≠ 16 x 8 mm  
 G x Y mm  
 800 x 800 mm



**551/220**  
 Ø 12 mm  
 G x Y mm  
 400 x 800 mm

**551A/220**  
 Ø 12 mm  
 G x Y mm  
 400 x 800 mm



**647/220**  
 Ø 12 mm  
 G x Y mm  
 750 x 880 mm  
 χειροποίητο τεμάχιο



**648/220**  
 Ø 12 mm  
 G x Y mm  
 750 x 550 mm



**649/220**  
 Ø 12 mm  
 G x Y mm  
 750 x 550 mm



**650/220**  
 ≠ 12x8 - 12x8 - 14x8 mm  
 ΔΙΑΜ. Ø 250 mm



**651/220**  
 Ø 12 mm  
 G x Y mm  
 600 x 880 mm



**652/220**  
 Ø 12 mm  
 G x Y mm  
 600 x 880 mm



**653/220**  
 Ø 12 mm  
 G x Y mm  
 750 x 880 mm



**654/220**  
 Ø 12 mm  
 G x Y mm  
 750 x 880 mm





655/221

≠ 14 x 8 mm

≠ 16 x 8 mm



656/221

≠ 14 x 8 mm

≠ 16 x 8 mm

H 770 x L 840



657/221

≠ 14 x 8 mm

≠ 16 x 8 mm

H 760 x L 830



658/221

∅ 12 x 12 mm

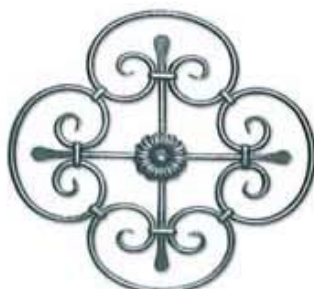

659/221

∅ 14 mm

H 560 x L 560



660/221

≠ 14x8 - 16x8 mm

H 710 x L 580



661/221

≠ 14 x 8 mm

≠ 16 x 8 mm

H 800 x L 480



662/221

≠ 12 x 6 mm



663/221

∅ 12/14 mm

H 800 x L 700

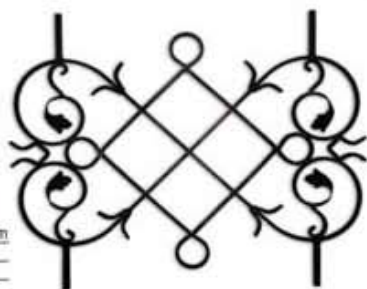

664/221

≠ 14x8 - 16x8 mm

G x Y mm

850 x 700 mm



665/221

≠ 14x8 - 16x8 mm

G x Y mm

850 x 300 mm



**666/222**

∅ 12 mm  
 Y 800 mm



**667/222**

∅ 12 mm  
 Y 800 mm



**668/222**

∅ 12 mm  
 Y 800 mm



**669/222**

G x Y  
 250 x 700 mm  
 ≠ 16 x 8 mm  
 20 x 8 mm  
 25 x 8 mm  
 30 x 8 mm



**670/222**

≠ 16 x 8 mm  
 20 x 8 mm  
 25 x 8 mm  
 30 x 8 mm



**671/222**

∅ 12/14 mm  
 H 800 x L 200



**672/222**

∅ 12 mm  
 Y 800 mm



**673/222**

∅ 12 mm  
 Y 800 mm



**674/222**

∅ 12 mm  
 Y 800 mm



**675/222**

∅ 12 mm  
 Y 800 mm



**582A/222**

∅ 12 mm  
 Y 800 mm



**617-1/222**

∅ 12/14 mm  
 Y 800 mm



**617-2/222**

∅ 8/10 mm  
 Y 800 mm



**537/222**

∅ 12 mm  
 Y 800 mm





**676/223**  
 $\varnothing$  12 mm  
 Y 800 mm



**677/223**  
 $\varnothing$  12 mm  
 Y 800 mm



**678/223**  
 $\varnothing$  12 mm  
 Y 800 mm



**679/223**  
 $\varnothing$  12 mm  
 Y 800 mm



**680/223**  
 $\varnothing$  12 mm  
 Y 800 mm



**681/223**  
 $\varnothing$  12 mm  
 Y 800 mm



**682/223**  
 $\varnothing$  12 mm  
 Y 800 mm



**530/223**  
 $\varnothing$  12 mm  
 Y 1000 mm



**683/223**  
 $\varnothing$  12 mm  
 Y 800 mm



**684/223**  
 $\varnothing$  12 mm  
 Y 800 mm



**685/223**  
 $\varnothing$  12 mm  
 Y 800 mm



**686/223**  
 $\varnothing$  12 mm  
 Y 800 mm



**687/223**  
 $\neq$  12x6 - 12x8 mm  
 $\neq$  14x6 - 14x8 mm  
 Y 800 mm



**523/224**  
 G 130 x Y 800



**688/224**  
 ≠ 14 x 8 mm  
 Y 800 mm



**689/224**  
 ∅ 12 mm  
 Y 800 mm



**690/224**  
 ∅ 12 mm  
 Y 800 mm



**691/224**  
 ≠ 16 x 8 mm  
 Y 800 mm



**524/224**  
 G 130 x Y 800



**115-1/224**  
 Y 800 mm



**692/224**  
 ∅ 14 mm



**540/224**  
 ∅ 12 mm  
 2,770 kg  
 G x Y mm  
 275 x 275 x 1000

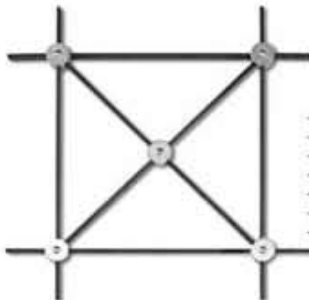

**693/224**  
 G x Y mm  
 450 x 450 mm  
 550 x 550 mm  
 ∅ 12/14 mm  
 ≠ 14 x 6 mm  
 ≠ 20 x 6 mm  
 ≠ 20 x 8 mm



**694/224**  
 ∅ 16 mm  
 ≠ 16 x 6 mm  
 G x Y  
 400 x 800 mm



**695/224**  
 ∅ 14  
 ≠ 14 x 8 mm  
 16 x 8 mm  
 20 x 8 mm  
 ΔIAM. ∅ 500







e -mail: [info@doukas.com.gr](mailto:info@doukas.com.gr) · <http://www.doukas.com.gr>

**ΚΕΝΤΡΙΚΟ**

Λ. ΑΘΗΝΩΝ 302-304,  
121 36 ΠΕΡΙΣΤΕΡΙ,  
ΤΗΛ: 210 5750057  
FAX: 210 5715799

**ΥΠΟΚΑΤΑΣΤΗΜΑ**

ΕΘΝΙΚΗ ΟΔΟΣ (κόμβος εθνικού σταδίου)  
30 100 ΑΓΡΙΝΙΟ,  
ΤΗΛ: 26410 24652  
FAX: 26410 21897

**ΚΕΝΤΡΟ ΔΙΑΝΟΜΗΣ**

ΔΑΦΝΗΣ 7  
12 200 ΑΙΓΑΛΕΩ

